

**APPENDIX A  
TRAFFIC AND TRANSPORT IMPACT ASSESSMENT  
REPORT**

---

**Agreement No. CE 92/2017 (CE)**

**Site Formation and Infrastructure Works  
for Public Housing Development near Tan Kwai Tsuen,  
Yuen Long – Investigation, Design and Construction**

**FINAL TRAFFIC AND  
TRANSPORT IMPACT  
ASSESSMENT REPORT FOR S16  
PLANNING APPLICATION  
(INTENSIFICATION SCHEME)**

199086/BIN/088/Issue 2  
November 2022



土木工程拓展署  
Civil Engineering and  
Development Department



**Agreement No. CE 92/2017 (CE)**

**Site Formation and Infrastructure Works  
for Public Housing Development near Tan  
Kwai Tsuen, Yuen Long – Investigation,  
Design and Construction**

---

**Final Traffic and Transport Impact  
Assessment Report for S16 Planning  
Application (Intensification Scheme)**

---

*Issue 2*

November 2022

	Name	Signature	Date
Prepared	Sam Lung / MVA		November 2022
Reviewed	Eunice Lee		November 2022
Authorized	Edwin Lo		November 2022

## CONTENTS

<b>1</b>	<b>INTRODUCTION .....</b>	<b>1</b>
1.1	Background.....	1
1.2	Project Description .....	1
1.3	Objectives and Scope of the Report.....	1
<b>2</b>	<b>EXISTING ROAD NETWORK .....</b>	<b>3</b>
2.1	Existing Road Network.....	3
2.2	Existing Traffic Conditions.....	3
<b>3</b>	<b>THE PROPOSED DEVELOPMENT .....</b>	<b>6</b>
3.1	Proposed Development Parameters .....	6
3.2	Car Parking and Loading/Unloading Provision .....	7
3.3	Proposed Local Road Network.....	10
3.4	Public Transport Service .....	11
3.5	Pedestrian Connection.....	16
3.6	Review of Impact on Rail Service .....	17
<b>4</b>	<b>TRAFFIC FORECASTING .....</b>	<b>20</b>
4.1	Design Year .....	20
4.2	General and Modelling Assumption .....	20
4.3	Traffic Model Methodology for Base Year Model.....	20
4.4	Traffic Model Methodology for Future Design Years.....	23
4.5	Future Road Network .....	23
4.6	Development Traffic Generations .....	25
4.7	Design Traffic Forecasts.....	26
<b>5</b>	<b>OPERATIONAL TRAFFIC IMPACT ASSESSMENT .....</b>	<b>27</b>
5.1	Overview .....	27
5.2	Critical Junction Assessment.....	27
5.3	Road Capacity Assessment.....	28
5.4	Proposed Improvement Scheme .....	30
5.5	Construction Traffic Impact.....	32
5.6	Sensitivity Study for Phases 1 & 2 Intake in 2030 .....	32
<b>6</b>	<b>Conceptual Temporary Traffic Management Schemes (TTMS).....</b>	<b>35</b>
6.1	Proposed Works.....	35
6.2	Basic Design Principles for TTMS.....	35
6.3	Conceptual TTMS.....	36
<b>7</b>	<b>SUMMARY AND CONCLUSION .....</b>	<b>38</b>

7.1 Summary .....	38
7.2 Conclusion .....	41

**END OF TEXT**

**LIST OF FIGURES**

Figure 1.1	Site Location
Figure 2.1	Existing Road Network
Figure 2.2	2021 Observed Traffic Flows
Figure 2.3	Existing Junction Layout of Hung Tin Road / Hung Chi Road (J1)
Figure 2.4	Existing Junction Layout of Castle Peak Road – Hung Shui Kiu / Hung Tak Road (J2)
Figure 2.5	Existing Junction Layout of Castle Peak Road – Hung Shui Kiu / Tan Kwai Tsuen Road (J3)
Figure 2.6	Existing Junction Layout of Tan Kwai Tsuen Road / Hung Shun Road (J4)
Figure 2.7	Existing Junction Layout of Castle Peak Road – Hung Shui Kiu / Shun Tat Street (J5)
Figure 2.8	Existing Junction Layout of Shun Tat Street / Tat Fuk Road (J6) and Shun Tat Street / Tung Fuk Road (J7)
Figure 2.9	Existing Junction Layout of Castle Peak Road – Lam Tei / Fuk Hang Tsuen Road (J8)
Figure 2.10	Existing Junction Layout of Castle Peak Road – Hung Shui Kiu / Hung Tin Road (J9)
Figure 2.11	Existing Junction Layout of Tan Kwai Tsuen Road / Shui Fu Road (J10)
Figure 3.1	Proposed Local Road Network
Figure 3.2	Proposed Junction Layout of Shun Tat Street / Proposed Access Road / Tat Fuk Road (J7)
Figure 3.3	Swept Path Test for Proposed Junction Layout of Shun Tat Street / Proposed Access Road / Tat Fuk Road (J7)
Figure 3.4	Proposed Improvement Scheme at Junction of Castle Peak Road – Hung Shui Kiu / Shun Tat Street (J5)
Figure 3.5	Proposed Junction Layout of Shui Fu Road and Proposed Access Road (J12)
Figure 3.6	Swept Path Test for Proposed Junction Layout of Shui Fu Road and Proposed Access Road (J12)
Figure 3.7	Proposed connection to TSWWI
Figure 4.1	Proposed Screenlines and Junctions for Validation
Figure 4.2	2034 Reference Traffic Flows
Figure 4.3	2034 Development Traffic Flows
Figure 4.4	2034 Design Traffic Flows
Figure 5.1	Proposed Improvement Scheme at Junction of Castle Peak Road – Lam Tei / Fuk Hang Tsuen Road (J8)
Figure 5.2	Proposed Construction Traffic Route before Proposed Access Road Along Yuen Long Highway in Place

Figure 5.3	Proposed Construction Traffic Route after Proposed Access Road Along Yuen Long Highway in Place
Figure 5.4	2030 Reference Traffic Flows
Figure 5.5	2030 Design Traffic Flows
Figure 6.1	Temporary Traffic Management at Junction of Castle Peak Road – Hung Shui Kiu / Shun Tat Street (J5) – Stage 1
Figure 6.2	Temporary Traffic Management at Junction of Castle Peak Road – Hung Shui Kiu / Shun Tat Street (J5) – Stage 2
Figure 6.3	Temporary Traffic Management at Junction of Castle Peak Road – Hung Shui Kiu / Shun Tat Street (J5) – Stage 3
Figure 6.4	Temporary Traffic Management at Junction of Castle Peak Road – Hung Shui Kiu / Shun Tat Street (J5) – Stage 4
Figure 6.5	Temporary Traffic Management at Junction of Shun Tat Street / Proposed Access Road / Tung Fuk Road (J7) – Stage 1
Figure 6.6	Temporary Traffic Management at Junction of Shun Tat Street / Proposed Access Road / Tung Fuk Road (J7) – Stage 2
Figure 6.7	Temporary Traffic Management at Junction of Shun Tat Street / Proposed Access Road / Tung Fuk Road (J7) – Stage 3
Figure 6.8	Temporary Traffic Management at Junction of Castle Peak Road – Lam Tei / Fuk Hang Tsuen Road (J8) – Stage 1
Figure 6.9	Temporary Traffic Management at Junction of Castle Peak Road – Lam Tei / Fuk Hang Tsuen Road (J8) – Stage 2
Figure 6.10	Temporary Traffic Management at Junction of Castle Peak Road – Lam Tei / Fuk Hang Tsuen Road (J8) – Stage 3
Figure 6.11	Temporary Traffic Management at Junction of Shui Fu Road / Proposed Access Road (J12) – Stage 1
Figure 6.12	Temporary Traffic Management at Junction of Shui Fu Road / Proposed Access Road (J12) – Stage 2

## **LIST OF TABLES**

**Table 2.1 – Existing Junctions Performance**

**Table 2.2 – Existing Road Links Performance**

**Table 3.1 – Latest Development Parameters for this Project**

**Table 3.2A – Internal Transport Provision for Public Housing Development**

**Table 3.2B– Parking Facilities for the Proposed Welfare Facilities**

**Table 3.2C– Parking Facilities for the Proposed Primary School**

**Table 3.3 – Pedestrian Trip Generation Rates**

**Table 3.4 – Main Mode of Transport to Place of Work/ Place of Study**

**Table 3.5 – Estimated Public Transport Demand (persons/hr)**

**Table 3.6 – Proposed Shuttle Bus & Long-Haul Bus Services**

**Table 3.6A – Assumed Service Level and Headway of Proposed Bus Services**

**Table 3.7 – Capacity of Proposed Footpath**  
**Table 3.8 – Existing Light Rail Services at Hung Shui Kiu**  
**Table 3.9 – Estimated Rail Service Demand <sup>(1)</sup> (passenger/hr)**  
**Table 3.10– Estimated Demand on Tuen Ma Line at AM Peak Hour**  
**Table 4.1 – Summary of Junction Count Validation Result**  
**Table 4.2 – Summary of Link Count Validation Result**  
**Table 4.3 – Adopted Major Highway Network Assumption**  
**Table 4.4 – Adopted Trip Rate for the Proposed Development**  
**Table 4.5 – Traffic Generation for the Proposed Housing Development**  
**Table 4.6 – Traffic Generation for the Proposed Public Transport Interchange**  
**Table 4.7 – Estimated Traffic Generation for the Proposed Development**  
**Table 5.1 – 2034 Junction Assessment**  
**Table 5.2 – Road Links Capacity Assessment for Design Year 2034**  
**Table 5.3 – Junction Performance under Proposed Improvement Scheme**  
**Table 5.4 – Estimated Traffic Generation for the Proposed Development in 2030**  
**Table 5.5 – 2030 Junction Assessment**  
**Table 5.6 – Junction Performance under Proposed Improvement Scheme**

## **LIST OF APPENDICES**

A Detailed Summary of Validation Results  
B Traffic Modelling Assumptions  
C Phasing Plan for Road Network under CE2/2011  
C1 Proposed Conceptual Layout of Castle Peak Road / Yick Yuen Road  
C2 Proposed Conceptual Layout of Castle Peak Road / Road P1  
C3 Proposed Improvement Scheme of Castle Peak Road/ Fuk Hang Tsuen Road  
D1 TD's Proposed Improvement Works for Junction of Castle Peak Road / Hung Tak Road  
D2 TD's Proposed Improvement Works for Junction of Castle Peak Road / Shun Tat Street  
D3 TD's Proposed Improvement Works for Junction of Castle Peak Road / Tan Kwai Tsuen Road  
E Calculation Details of Junction Assessment  
F Swept Path and Visibility Analysis  
G Lift Capacity Analysis  
H Preliminary Layout for Traditional and Sawtooth Type PTI  
I Planned Roundabout near Tin Shui Wai West Interchange

## 1 INTRODUCTION

### 1.1 Background

- 1.1.1 As a prevailing policy to increase land supply to meet the housing demand in the short, medium and long terms, the Government has identified sites in various districts with the potential to be developed for residential use. Amongst others, a site near Tan Kwai Tsuen (the Site), Yuen Long has been identified for public housing developments.
- 1.1.2 In view of the acute shortage of housing, the domestic PR of the Site is proposed to be intensified to 6.5 with an aim to increase flat production. The Site will provide a total of 7,420 public housing units with planned population intake from 2030 by phases.
- 1.1.3 Binnies Hong Kong Limited was requested by the Civil Engineering and Development Department (CEDD) to prepare necessary technical assessments of Section 16 (S16) planning application for minor relaxation of PR and building height restriction for the agreement of the Town Planning Board (TPB).

### 1.2 Project Description

- 1.2.1 The Site for the proposed public housing development is currently rural area overlooked by natural hillside, located on the south of the existing Tan Kwai Tsuen South Fresh Water Service Reservoir adjacent to Yuen Long Highway. The site location is shown on **Figure 1.1**.
- 1.2.2 The proposed development comprises public housing development of about 7,420 flats and the associated facilities such as retail, welfare and other facilities (e.g. kindergarten, public transport interchange etc.) to support the public housing development and is tentatively scheduled for population intake from 2030 by phases.
- 1.2.3 The proposed infrastructure works including, but not limited to the provision of new roads and the improvements to existing road networks; construction of lift tower, provision and construction of PTI, provision of necessary utilities such as watermains, sewers and drains leading to/ from the proposed public housing development.

### 1.3 Objectives and Scope of the Report

The scope of the Traffic and Transport Impact Assessment (TTIA) will be in accordance with Paras. 6.2.80 to 6.2.91 and 6.2.93 to 6.2.96 of the Brief of the IDC Study. The main objectives of this TTIA Report are:

- 1.3.1 to assess the potential traffic impact arising from the increase of total maximum plot ratio from 6.5 to 7.0 (i.e. domestic PR of 6.5 and non-domestic PR of 0.5) for Phase 1,



- 6.5 to 7.2 (i.e. domestic PR of 6.5 and non-domestic PR of 0.7) for Phase 2 and 6.5 to 7.3 (i.e. domestic PR of 6.5 and non-domestic PR of 0.8) for Phase 3 respectively; and
- 1.3.2 to review and update the previously approved TTIA report.
- 1.3.3 The Report contains the following sections in addition to this introduction (Section 1):
- Section 2** – describes and appraise the existing traffic situation in the vicinity of the proposed Development;
  - Section 3** – presents and discusses the development schedules, proposed road networks and public transport facilities serving the proposed Development;
  - Section 4** – presents the modelling methodology and the future year traffic forecasts;
  - Section 5** – presents the results of operational traffic impact assessment in design years and proposed improvement schemes; &
  - Section 6** – provides a summary of the study findings.

## 2 EXISTING ROAD NETWORK

### 2.1 Existing Road Network

- 2.1.1 The proposed Development is located on the southeast of Tan Kwai Tsuen, Yuen Long, which is bounded by the Yuen Long Highway to the west, Tin Shui Wai West Interchange (TSWWI) to the north, and Shun Tat Street to the south.
- 2.1.2 Yuen Long Highway is a dual three-lane expressway. It is the main road linking the Tan Kwai Tsuen area to the rest of Hong Kong. Traffic can reach New Territories North via San Tin Highway at its eastern end, reach Kowloon and New Territories East via Tsing Long Highway and Tai Lam Tunnel at its eastern end, reach Tuen Mun and Kowloon via Tuen Mun Road at its western end.
- 2.1.3 Castle Peak Road – Hung Shui Kiu is a dual rural trunk road running in east-west direction with 2 traffic lanes on eastbound carriageway while 2 to 3 traffic lanes on westbound carriageway. It links up with Yuen Long Highway at its western direction via Lam Tei Interchange and eastern direction via Hung Tin Road.
- 2.1.4 Hung Tin Road is a dual two-lane district distributor running north-south providing a connection between Castle Peak Road to Yuen Long Highway and Tin Shui Wai.
- 2.1.5 Tan Kwai Tsuen Road is a single carriageway rural road serving the local villages located to the south of Castle Peak Road, with 2 traffic lanes running in a north-south direction with its northern end connected to Castle Peak Road while its southern end is a dead end. The section of Tan Kwai Tsuen Road between Castle Peak Road and Shui Fu Road is a standard 7.3m wide single 2-lane carriageway.
- 2.1.6 Shun Tat Street is a single 2-lane carriageway running parallel to Tan Kwai Tsuen Road. It also links up with Castle Peak Road – Hung Shui Kiu at its northwest end in a form of signalized junction and connects to the existing North West New Territories (NWNT) Refuse Transfer Station (RTS) to its southern end.

### 2.2 Existing Traffic Conditions

- 2.2.1 In order to determine the existing traffic demand within the AOI during peak periods, traffic survey in the form of manual classified counts were carried out during the periods from 0730 to 0930 and from 1700 to 1900 of a typical weekday in November of year 2021. The existing road network in the vicinity of the Site with locations of the surveyed junctions / road links are illustrated in **Figure 2.1**.
- 2.2.2 Analysis of the observed traffic data indicates that the AM and PM peak hour flows occurred from 0800 to 0900 and from 1730 to 1830 respectively. The observed peak hour traffic flows are summarized and presented in **Figure 2.2**.
- 2.2.3 Operational performance of the existing key junctions was assessed based on the guidelines stipulated in the Transport Planning and Design Manual (TPDM) during AM and PM peak hours. The performance of a signalized junction is indicated by its reserve capacity (RC). A RC above 15% is considered as satisfactory. A positive RC figure indicates that the junction is operating with spare capacity; and a negative RC

figure indicates that the junction is overloaded, hence resulting in traffic queues and longer travelling time. The Design Flow to Capacity (DFC) ratio reflects the performance of a non-signalised junction. A DFC ratio below 0.85 is satisfactory. A DFC ratio between 0.85 and 1.00 is undesirable; and a DFC ratio greater than 1.00 denotes overcapacity.

2.2.4 The existing junction layouts of the key junctions are shown in **Figures 2.3-2.11** respectively. The assessment results are listed in **Table 2.1** below.

**Table 2.1 – Existing Junctions Performance**

Ref.	Junction	Method of Control	Figure	2021 RC/DFC <sup>(1)</sup>	
				AM Peak	PM Peak
J1	Hung Tin Road / Hung Chi Road	Signal	2.3	46%	76%
J2	Castle Peak Road – Hung Shui Kiu / Hung Tak Road	Signal	2.4	46%	91%
J3	Castle Peak Road – Hung Shui Kiu / Tan Kwai Tsuen Road	Signal	2.5	65%	>100%
J4	Tan Kwai Tsuen Road / Hung Shun Road	Priority	2.6	0.40	0.33
J5	Castle Peak Road – Hung Shui Kiu / Shun Tat Street	Signal	2.7	91%	91%
J6	Shun Tat Street / Tat Fuk Road	Priority	2.8	0.06	0.04
J7	Shun Tat Street / Tung Fuk Road	Priority	2.8	0.17	0.12
J8	Castle Peak Road – Lam Tei / Fuk Hang Tsuen Road	Signal	2.9	13%	6%
J9	Castle Peak Road – Hung Shui Kiu / Hung Tin Road	Signal	2.10	64%	43%
J10	Tan Kwai Tsuen Road/ Shui Fu Road	Priority	2.11	0.10	0.09

Note: (1) RC = Reserve Capacity, DFC = Design Flow to Capacity

2.2.5 The results in **Table 2.1** indicate that all the key junctions are currently operating within capacities during AM and PM peak except J8 is operating marginally at capacity (i.e. 6%) during PM peak period.

2.2.6 Existing road link performances of critical links are summarized in below **Table 2.2**. The Volume/Capacity (V/C) Ratio reflects the performance of a road. A V/C Ratio equals to or less than 1.0 means that the road has sufficient capacity to cope with the volume of vehicular traffic under consideration and the resultant traffic will flow smoothly. A V/C Ratio between 1.0 and 1.2 indicates a manageable degree of congestion, and that above 1.2 indicates more serious congestion.

**Table 2.2 – Existing Road Links Performance**

Ref.	Road	Direction	Capacity <sup>(1)</sup> (pcu/hr)	2021 Observed Flow (pcu/hr)		V/C Ratio	
				AM Peak	PM Peak	AM Peak	PM Peak
J11	Slip Road from Yuen Long Highway (WB) to Hung Tin Road (NB)	NB (1)	1,800 <sup>(5)</sup>	1,465	1,425	0.81	0.79

Ref.	Road	Direction	Capacity ( <sup>(1)</sup> pcu/hr)	2021 Observed Flow (pcu/hr)		V/C Ratio	
				AM Peak	PM Peak	AM Peak	PM Peak
	Slip Road from Yuen Long Highway (EB) to Hung Tin Road (NB)	NB (1)	1,800 <sup>(5)</sup>	965	1,230	0.53	0.68
	Slip Road from Hung Tin Road (SB) to Yuen Long Highway (EB)	EB (1)	1,800 <sup>(5)</sup>	1,330	830	0.74	0.46
	Slip Road from Hung Tin Road (SB) to Yuen Long Highway (WB)	WB (1)	1,800 <sup>(5)</sup>	1,490	1,085	0.83	0.60
L1	Yuen Long Highway – Tin Shui Wai	EB (3)	6,110 <sup>(2)</sup>	5,110	5,005	0.84	0.82
		WB (3)	6,110 <sup>(2)</sup>	4,700	4,475	0.77	0.73
L2	Hung Tin Road	NB (2)	3,600 <sup>(1)</sup>	2,430	2,655	0.68	0.74
		SB (2)	3,600 <sup>(1)</sup>	2,820	1,915	0.78	0.53
L3	Castle Peak Road – Hung Shui Kiu	EB (2)	2,860 <sup>(3)</sup>	1,330	1,565	0.47	0.55
		WB (2)	2,860 <sup>(3)</sup>	975	1,050	0.34	0.37
L4	Shun Tat Street	NB (1)	1,055 <sup>(4)</sup>	220	190	0.21	0.18
		SB (1)	1,055 <sup>(4)</sup>	220	215	0.21	0.20

Notes: (1) Based on TPDM Volume 2 Chapter 2.4, peak hourly design flow for dual 2 lane expressway/trunk road is 3000 veh/hr per one direction of flow. Take pcu factor as 1.3, the link capacity is 3900 pcu/hr. For district distributor at Hung Tin Road, 0.9 factor is applied to reflect the lowered class of road hierarchy, i.e. 3600 pcu/hr.  
 (2) Based on TPDM Volume 2 Chapter 2.4, peak hourly design flow for dual 3 lane expressway is 4700 veh/hr per one direction of flow. Take pcu factor as 1.3, the link capacity is 6110 pcu/hr.  
 (3) Based on TPDM Volume 2 Chapter 2.4, peak hourly design flow for dual 4 lane district distributor (with frontage, bus stops and pedestrian crossings) undivided carriageway is 2000 veh/hr per one direction of flow. With reference to difference in design flow between undivided carriageway and dual carriageway of primary distributor, 200 veh/hr design flow is added to undivided carriageway arrangement, i.e. 2200 veh/hr design flow per one direction of flow of dual carriageway is adopted. Take pcu factor as 1.3, the link capacity is 2860 pcu/hr.  
 (4) Based on TPDM Volume 2 Chapter 2.4, peak hourly design flow for 2 lane 10m width undivided carriageway is 2200 veh/hr for both direction of flow. For local road type at Shun Tat Street, 0.8 factor is applied to reflect the lowered class of road hierarchy, i.e. 1760 veh/hr 2-way. Take local road pcu factor as 1.2, the link capacity is 2110 pcu/hr, 2-way, i.e. 1055 pcu/hr per direction.  
 (5) 1800 pcu/hr link capacity for one lane slip road is adopted for consistency amongst other projects

2.2.7 The results in **Table 2.2** indicate that all the above road links are currently operating within capacity (i.e. V/C ratios below 1.0.).

### 3 THE PROPOSED DEVELOPMENT

#### 3.1 Proposed Development Parameters

3.1.1 The latest development parameters of the proposed Development are summarized in **Table 3.1**.

**Table 3.1 – Latest Development Parameters for this Project**

Land Use	No. of Flats/ GFA (m <sup>2</sup> )	Population	Year of Population intake
<b>Domestic</b>			
Public Housing – PRH	5,450 flats	14,715	from 2030 by phases
Public Housing – SSF	1,970 flats	5,319	
<u>Sub-Total</u>	<u>7,420 flats</u>	<u>20,034</u>	
<b>Non-Domestic</b>			
200 place Residential Care Home for the Elderly (RCHE)	5,198	-	from 2030 by phases
60 place Day Care Centre for the Elderly (DE)	752	-	
Neighbourhood Elderly Centre (NEC)	636	-	
100 place Hostel for Severely Mentally Handicapped Persons	2,902	-	
100 place Day Activity Centre (DAC)	1,340	-	
50 place Hostel for Moderately Mentally Handicapped Persons	1,296	-	
50 place Hostel for Severely Physically Handicapped Persons	1,460	-	
120 place Integrated Vocational Rehabilitation Services Centre	1,371	-	
Welfare-lift tower	901	-	
<u>Sub-Total (Welfare)<sup>(1)</sup></u>	<u>15,856</u>	-	
Retail	5,912	-	
Office <sup>(2)</sup>	1,098	-	
Kindergarten 1	8-classroom	-	
Kindergarten 2	7-classroom	-	
Primary School	30-classroom	-	

Note

(1) Subject to SWD's confirmation on funding and facilities area. According to the 2020 Policy Address on Additional Welfare Facilities in Public Housing Developments, 5% of the total GFA exclusively for welfare uses have been provided and adopted in the assessment.

(2) Ancillary facilities such as District Councillor's Office and Estate Management Office, etc. are considered as office uses for conservative estimate of the traffic impact.

### 3.2 Car Parking and Loading/Unloading Provision

3.2.1 Based on the proposed development parameters as shown in **Table 3.1**, the required provisions of car parking spaces, motorcycle parking, loading/unloading bays and layby in accordance with the latest Hong Kong Planning Standards and Guidelines (HKPSG) are summarized in **Table 3.2A-C**. To meet the increasing parking demand in the territory, it is recommended to adopt the high-end of the HKPSG parking and loading/ unloading provision.

**Table 3.2A – Internal Transport Provision for Public Housing Development**

Land use	Internal Transport Facilities	HKPSG Requirement (1)	Required Provision(2)
Domestic Public Rental Housing (5 blocks) 1) 5,450 flats (including 1,030 "one-person/ two-person flats") (Note 3) Subsidised Housing (2 blocks) 2) 1,970 flats  Non-Domestic 3) Retail = 5,912 m2 GFA 4) Kindergarten 1 7-classroom 5) Kindergarten 2 8-classroom	Private Car parking space	<u>Residential</u> • Parking Requirement = GPS x Demand Adjustment Ratio (R1) x Accessibility Adjustment Ratio (R2) • GPS = 1 car space per 4 – 7 flats • R1 = 0.52 • R2 = 1.0 PRH Required Provision = 329 - 575 SSF Required Provision = 147 - 257	476 – 832
		<u>Visitor parking</u> • 5 parking spaces per domestic block, as required by HD	35
		<u>Retail</u> • 1 car space per 150 – 300m <sup>2</sup> GFA	20-40
		<u>Kindergarten</u> • 0 to 1 car parking space per 4 to 6 classrooms	0-4 (Note 4 & 5)
	LGV / PrLB parking space	<u>Residential</u> • 1 per 260 flats  PRH Required Provision = 18 SSF Required Provision = 8	26
	Motorcycle parking space	<u>Residential</u> • 1 per 110 – 250 flats  PRH Required Provision = 18 - 41 SSF Required Provision = 8 - 18	26 - 59
	Bicycle parking space	<u>Residential</u> • 1 for every 15 flats	496

Land use	Internal Transport Facilities	HKPSG Requirement <sup>(1)</sup>	Required Provision <sup>(2)</sup>
		PRH Required Provision = 364 SSF Required Provision = 132	
	Lay-by for taxis and private cars	<u>Kindergarten</u> • 1 lay-by for every 5 – 8 classrooms	0 – 3 (Note 4 & 5)
	Lay-by for school buses	<u>Kindergarten</u> • Minimum 2 lay-bys	0 – 5 (Note 4 & 5)
	Loading/ Unloading Bay	<u>Residential</u> • Minimum 2 L/UL bay around each residential block (also use for overnight parking of M/HGV / Coach with due consideration of the site constraint and local situation)  <u>Retail</u> • 1 L/UL bay for every 800 – 1200m <sup>2</sup> GFA	14 (2 per block)  5 – 8

Note:

- (1) According to HKPSG Chapter 8, "One person/two persons" flats shall be excluded from the calculation of the overall parking provision for private cars, LGV and motorcycle.
- (2) The actual provision shall be subject to agreement between HD and TD in detailed design stage.
- (3) Tentative 1,030 numbers of "one-person/ two-person" flats shall be provided to PRH. Final flat mix shall be subject to detailed design.
- (4) According to HKPSG Chapter 8, for kindergartens within public housing estates, the car parking provisions, taxi and private car lay-bys and loading / unloading provisions should be subject to the requirements of Housing Authority.
- (5) According to HKPSG Chapter 8, for kindergartens, "Nil provision" for car parking and loading / unloading (including lay-by for taxis and private cars, lay-by for school buses) may be permitted for those kindergartens within general purpose building.

**Table 3.2B – Parking Facilities for the Proposed Welfare Facilities**

	Welfare Facilities	Phase	Transport Facilities	Proposed Provision
1.	Day Care Centre for the Elderly (DE) (60-place)	Phase 3	Private light bus parking (8m(L) x 3m(W) x min. 3.3m (H))	3 nos.
			Loading / Unloading lay-by	1 no.
2.	Residential Care Home for the Elderly (RCHE) (200-place)	Phase 3	Private light bus parking (8m(L) x 3m(W) x min. 3.3m (H))	1 no.
			Loading / Unloading lay-by	1 no.
3.	Hostel for Severely Mentally Handicapped Persons (HSMH) (100-place)	Phase 2	Private light bus parking (8m(L) x 3m(W) x min. 3.3m (H))	2 no.
			Loading / Unloading lay-by	1 no.
4.	Hostel for Severely Physically Handicapped Persons (HSPH) (50-place)	Phase 1	Private light bus parking (8m(L) x 3m(W) x min. 3.3m (H))	1 no.

	Welfare Facilities	Phase	Transport Facilities	Proposed Provision
5.	Integrated Vocational Rehabilitation Services Centre (IVRSC) (120-place)	Phase 1	Parking space for a 5.5-ton goods vehicle (7m(L) x 3.5m(W) x min. 3.6m (H))	1 no.

\* Whether welfare parking facilities can be shared within the same phase shall be subject to agreement with Social Welfare Department.

**Table 3.2C – Parking Facilities for the Proposed Primary School**

Land Use	Transport Facilities *	HKPSG Requirement	Required Provision
Primary School 30-classroom	Private car parking	1 car parking space per 4 to 6 classrooms	5 – 8 nos.
	Lay-by for taxis and private cars	1 lay-by for every 2 to 3 classrooms	10 – 15 nos
	Lay-by for school buses	Minimum 3 lay-bys within the school boundary	3 nos

\* The parking facilities would be located within the school site.



### 3.3 Proposed Local Road Network

3.3.1 Under Feasibility Stage several design options had been explored with respect to civil and land constraint, programme implication, traffic impact on the development and network in vicinity to provide direct and convenience access to the proposed Site. The proposed local road network is shown in **Figure 3.1** with the design intention described as follows.

3.3.2 A single 2-lane access road running along and parallel to the eastern side of Yuen Long Highway is proposed to provide external connection for the Site. A proposed public access road between the upper and lower platforms will form a junction with the single 2-lane access road parallel to Yuen Long Highway in the form of a roundabout. The swept path analysis had been conducted for 12m long fire truck and is presented in **Appendix F**.

#### Connection to Castle Peak Road via Shun Tat Street

3.3.3 The proposed single 2-lane access road will connect to the existing Shun Tat Street at its southern end near the existing NWNT RTS to provide primary access to Castle Peak Road – Hung Shui Kiu for the Site. Due to the site constraints imposed by the existing NWNT RTS and Yuen Long Highway, the junction of Shun Tat Street / Tung Fuk Road (J7) will be modified in the form of signal control to accommodate the traffic flow generated by the proposed Development. The proposed junction layout with corresponding method of control are illustrated in **Figure 3.2**.

3.3.4 The modified junction layout was justified by swept path analysis and presented in **Figure 3.3**. The design principles of the modification to J7 will ensure the impact on the operation of the NWNT RTS will be kept to a minimum and the junction performance with the modified junction layout will be assessed in **Section 5**.

3.3.5 With the aim to serve the Site as a primary site access route, it is proposed to modify the layout of junction of Castle Peak Road/ Shun Tat Street (J5) to provide a right turning movement from Shun Tat Street to allow traffic access to Yuen Long direction by making minor change to the existing method of control. The proposed junction layout with the corresponding method of control are illustrated in **Figure 3.4**. Junction performance with the modified junction layout will be also assessed in **Section 5**.

#### Connection to Yuen Long Highway via TSWWI

3.3.6 In addition to the abovementioned provision of at-grade site access to Castle Peak Road, it is noted that under Yuen Long South housing site project, it will extend the proposed access road northwards to connect with the existing slip road at TSWWI to provide a secondary access for the Site. Under such arrangement, the development traffic would be able to access Yuen Long Highway for access to Yuen Long and Tin Shui Wai areas. Apart from the above, this connection can also serve as an alternative access for the Site, should there be any incident occur at the development access via Castle Peak Road – Hung Shui Kiu. The proposed indicative connection with TSWWI is shown in **Figure 3.7** and the planned works by Yuen Long South is presented in

**Appendix I.** It is anticipated that the connection between proposed access road, Yuen Long Highway and Hung Tin Road will be included in Stage 2 Phase 2 of the Yuen Long South project which is anticipated to be completed by end of 2031.

#### Connection to Castle Peak Road via Tan Kwai Tsuen Road

- 3.3.7 In order to further improve the public accessibility to the proposed GIC facilities and PTI at the Site, it is proposed to connect the new access road with the existing Shui Fu Road. Such proposal had not been considered at the Feasibility Study. Upon review, it is proposed to connect the new access road with the existing Shui Fu Road at its “Hairpin” turn adjacent to the existing Tan Kwai Tsuen North Fresh Water Service Reservoir.
- 3.3.8 This alternative access to Castle Peak Road – Hung Shui Kiu via Shui Fu Road and Tan Kwai Tsuen Road could enhance the connectivity between the Site and the surrounding areas, in particular the site accessibility to the Tan Kwai Tsuen local village and Hung Shui Kiu Light Rail Station.
- 3.3.9 **Figure 3.5** shows the proposed junction design including MOC plan. The proposed junction design will be able to accommodate the turning movement to/ from Shui Fu Road. The section of footpath along the uphill direction near the “Hairpin” turn of Shui Fu Road is proposed to be omitted and re-provided to the opposite side to further connect with the proposed footpath along the proposed access road.
- 3.3.10 The existing traffic arrangement for Shui Fu Road to prohibit all vehicles above 7m length from access to Shui Fu Road is proposed to be remain unchanged.
- 3.3.11 The proposed junction layout was justified by swept path analysis for fire truck of 12m long and presented in **Figure 3.6**. and the junction performance with the modified junction layout will be assessed in **Section 5**.

### **3.4 Public Transport Service**

#### Existing Condition

- 3.4.1 Located on the outskirts of Yuen Long, the Site is relatively inconveniently located in terms of existing public transport facilities. There are a numbers of franchised bus routes all running along Castle Peak Road – Hung Shui Kiu during the peak hour, however, the Site is not served by any of these routes. The closest on-street bus stops on Castle Peak Road are more than 900m away, which are considered out of typical walking distances from the Site.
- 3.4.2 Furthermore, with reference to the latest Bus Route Development Plans in the local area provided by TD, there will not be major changes to the bus routes serving Castle Peak Road in the vicinity of the Site.
- 3.4.3 The closest Light Rail Stop to the Site is Hung Shui Kiu stop, which is situated approximately 1,000m from the Site.

Future Demand – Pedestrian Trip

- 3.4.4 With respect to factors such as limited accessibility to public transport facilities, it is important to review the future public transport demand for the proposed Development.
- 3.4.5 The future public transport demand for the proposed Development is estimated based on the person trip rates surveyed at similar nearby developments and the modal split of the corresponding District Council Constituency Area making reference to the result of 2016 Population By-census.
- 3.4.6 To review the pedestrian trip rate, a pedestrian trip generation survey was carried out at three selected public housing development on a typical weekday during the AM (07:30-09:30) and PM (17:00-19:00) peak periods. The peak hourly pedestrian trip generated and attracted by the surveyed developments were recorded and summarised in **Table 3.3**.

**Table 3.3 – Pedestrian Trip Generation Rates**

Surveyed Residential Development	Intake Year	No. of Flat	Pedestrian/hr				Pedestrian Trip Rate (ped/hr/flat)			
			AM		PM		AM		PM	
			Gen	Att	Gen	Att	Gen	Att	Gen	Att
Yau Oi Estate Oi Shun House	1980	731	355	106	165	323	0.486	0.145	0.226	0.442
Lung Yat Estate Kin Lung House	2013	429	177	41	105	183	0.413	0.096	0.245	0.427
Hung Fuk Estate Hung Foon House	2015	688	406	56	169	356	<b>0.590</b>	<b>0.082</b>	<b>0.246</b>	<b>0.521</b>

- 3.4.7 The 3 sites were chosen based on a number of factors aimed at replicating the transport characteristics envisaged for the Site. In terms of geography and transport accessibility, Lung Yat Estate on the south of Tuen Mun Kau Hui is similar to the Site, despite the flat sizes of the development being inconsistent with the intended floor areas with average flat size of 40m<sup>2</sup>.
- 3.4.8 In terms of the population intake year, Lung Yat Estate and Hung Fuk Estate are the most recent intake public housing in the vicinity.
- 3.4.9 Location wise, Hung Fuk Estate might be the closest public housing development to the Development.
- 3.4.10 Moreover, Hung Fuk Estate records the highest pedestrian trip generation rate at peak hour comparing to that of Lung Yat Estate. For conservative approach, the surveyed pedestrian trip generation rate at Hung Fuk Estate will be adopted to derive the future public transport demand.

### Future Demand – Modal Split

- 3.4.11 The mode of transport in Yuen Long New Town from 2016 Population By-census could be broadly split into two group, namely, to place of work and to place of study. The details are summarized and presented below in **Tables 3.4**.

**Table 3.4 – Main Mode of Transport to Place of Work/ Place of Study**

Trip Nature	Bus and Public Light Bus	Mass Transit Rail	Light Rail Transit	Private Car / Taxi	On foot	Others <sup>(1)</sup>	Total <sup>(2)</sup>
To place of work	66614	84441	22488	21298	18620	13046	226507
	29.4%	37.3%	9.9%	9.4%	8.2%	5.8%	100%
To place of study	4845	1596	3843	2798	7824	5266	26172
	18.5%	6.1%	14.7%	10.7%	29.9%	20.1%	100%

Notes:

(1) Include company bus/van, residential coach service, school bus and others

(2) The employment population/ student with no fixed places of work/ study in Hong Kong are excluded

- 3.4.12 It is assumed three categories including “private car/ taxi”, “on foot” and “others” would not travel via public transport and the corresponding percentages are 23.4% and 60.7% respectively for working population to place of work and person attending full-time courses to place of study.
- 3.4.13 As mentioned on the above, the closest public transport is more than 900m away from the development site. For conservative approach, it is assumed the travel pattern of “to place of work “ will only consider “Private Car/ Taxi” and “Other” from the proposed Development would travel via private transport regardless of trip nature, while the remaining 84.8% of future demand will take public transit.
- 3.4.14 Making reference to the pedestrian trip generation rate of Hung Fuk Estate and the modal split taking public transit including bus and public light bus, mass transit rail and light rail transit (i.e. 84.8%), the public transport passenger trips generated and attracted by the proposed Development is estimated and presented in **Table 3.5**.

**Table 3.5 – Estimated Public Transport Demand (persons/hr)**

Development	No. of Flat	AM Peak			PM Peak		
		Gen	Att	2-way	Gen	Att	2-way
The Development near TKT	7,420	3,713	516	4,229	1,548	3,279	4,827

- 3.4.15 As shown in the table above, the proposed Development would generate 3,713 and attract 3,279 persons travel via public transport (critical one-way) during the AM and PM peak hours respectively.
- 3.4.16 **Table 3.6** summarizes the forecasted AM peak demand (i.e. outbound direction) on the shuttle bus services together with the estimated number of bus routes required based on the latest updated development parameter for proposed Development. The assumed service level and headway of the proposed bus services are shown in **Table 3.6A**.

**Table 3.6 – Proposed Shuttle Bus & Long-Haul Bus Services**

Development	AM Peak Outbound Direction Public Transport Demand (patronage/hr)	Required Bus Trips <sup>(1)</sup> (bus/hr)	Required Bus Routes <sup>(2)</sup>
The Development near TKT	3,713	36	5

Note:

- 1) Based on an occupancy of 90 passengers per bus (75% of full bus capacity [120 passengers])
- 2) Based on frequency of 5-8 minutes and 7-10 minutes for short-haul and long-haul bus routes respectively

**Table 3.6A – Assumed Service Level and Headway of Proposed Bus Services**

Proposed Bus Route	PT Services	Capacity (passengers)	Occupancy	Assumed Capacity (passengers)	Assumed Headway	Provided Capacity (passengers)
1	Bus (Long-haul) <sup>(1)</sup>	120	75%	90	7	771
2	Bus (Long-haul) <sup>(1)</sup>	120	75%	90	8	675
3	Bus (Long-haul) <sup>(1)</sup>	120	75%	90	8	675
4	Bus (Long-haul) <sup>(1)</sup>	120	75%	90	10	540
5	Bus (Short-haul) <sup>(2)</sup>	120	75%	90	5	1080
<b>Total</b>						<b>3,741</b>

Note:

- (1) Subject to the Bus Route Development Plans in later stage, long-haul bus is proposed to provide services to urban areas and airport.
- (2) Subject to the Bus Route Development Plans in later stage, short-haul bus is proposed to serve as shuttle / feeder bus service between the proposed Development and nearby railway station.

3.4.17 Based on the estimated public transport demand, an off-street public transport interchange (PTI) with a minimum of 1 double width bus bay and 4 single width bus bays is required. In order to further enhance the public transport services, service for green minibus and taxi layby would also be provided within the PTI for convenience of residents. In order to further enhance the public transport services, a 39m and 24m long laybys along the eastern and western kerbsides of the proposed access road respectively are proposed and reserved for public transport use. Approximate 25m long taxi layby would be provided near the cul-de-sac of the proposed access road accessing upper and lower different platforms as shown in **Figure 3.1** for convenience of residents.

3.4.18 Currently, the Tuen Ma Line is the only mass transit railway serving the Hung Shui Kiu area. It provides railway service between Tuen Mun and Kowloon. Tin Shui Wai

Station is now the nearest existing West Rail station to the Site and located at the eastern edge of Hung Shui Kiu area. The construction of the main works of Hung Shui Kiu Station is expected to commence in about 2024 for completion in 2030 to tie in with the development programme of HSK/HT NDA. The station will be located approximately 1.5km away from the Site, which will be relatively more attractive to the residents of the proposed Development comparing with Tin Shui Wai Station. Therefore, a shuttle/ feeder bus service is proposed to provide a circulation route between the proposed Development and Hung Shui Kiu Station via Shun Tat Street.

- 3.4.19 A long-haul bus service connecting the proposed Development with urban areas should be provided in parallel with Tuen Ma Line to serve the passenger demand between the Site and urban areas (i.e. Kowloon/ Hong Kong Island) via Tin Shui Wai MTR Station - Tai Lam Tunnel.
- 3.4.20 Apart from the mass transit, the existing light rail transit in the New Territories Northwest provides both intra and inter district public transport services for Tuen Mun, Hung Shui Kiu, Tin Shui Wai and Yuen Long districts. However, its catchment does not cover the Site and thus it is proposed another long-haul bus service to urban area via Shun Tat Street - Castle Peak Road – Tai Lam Tunnel.
- 3.4.21 In addition to east-bound bus service, it is proposed one of the long-haul bus services for destinations in Kowloon and Hong Kong Island via Tuen Mun.
- 3.4.22 To enhance the transport linkage with new towns in the New Territories, it is proposed the remaining long-haul bus service to Lantau Island (i.e. Airport) calling at Tung Chung.
- 3.4.23 Due to the Bus Route Development Plans for the local area in long-term when the proposed Development scheduled for population intake from 2030 by phases is currently not available, the proposed bus service including the destination and bus routing are subject to further review in later detailed design stage.
- 3.4.24 In addition, one green minibus stand will also be provided within the PTI. Due to the long period from population intake at 2030, the proposed green minibus service including the destination and routing(s) are subject to further review in later detailed design stage.

Comparison of Traditional and Sawtooth Type PTI

- 3.4.25 Based on the discussion in Para. 3.4.16 to 3.4.17 above and further discussion with TD, a total of 5 terminating bus bays, 1 en-route bus bay, a green minibus stand and a taxi stand will be provided within the PTI. Taking into account of the requirements on designating column-free areas, charging-enabling facilities for electric buses, GMB and taxis and column design of the podium, both traditional and sawtooth type PTI are explored and the preliminary layout are presented in Appendix H for reference. For the sawtooth type PTI, larger column sizes are required to support the podium due to wider spacing between the peripheral and central islands. As such, the size of a sawtooth PTI will be larger than that of the traditional parallel platforms design. The sawtooth PTI will exceed the gazette boundary which may affect the school site on the southwest and the housing block layout on the southeast.

3.4.26 On the other hand, the available area of the PTI (within the gazette boundary) could only accommodate 4 terminating bus bays (with 8 stacking spaces), a green minibus stand and a taxi stand if sawtooth type PTI is adopted, which is not able to cope with the anticipated public transport demand from the proposed development as presented in **Table 3.6** above. Therefore, within the available area of the PTI, it is recommended to adopt a traditional type PTI to cater for the anticipated public transport demand. Moreover, the detailed design of the PTI will be subject to HD's design.

### 3.5 Pedestrian Connection

3.5.1 The proposed pedestrian network plan for the proposed development is illustrated in **Figure 3.1**. It is considered the proposed development is relatively remote and far away from the existing public transport facilities at Tan Kwai Tsuen area along Castle Peak Road, it is anticipated that the majority of pedestrian activities of the proposed developments will take place within and between the housing developments and the proposed public transport interchange (PTI), primary school or retail stores.

3.5.2 For the footpaths along the proposed access road accessing upper and lower different platforms from the cul-de-sac to the PTI, 2.75m effective width on both sides will be provided. Due to large level difference between the upper and lower platforms, internal lifts and footbridge are recommended to link up the two platforms across the proposed access road. Residents could access the proposed footbridge via the internal footpaths within the housing sites conveniently. It is anticipated that main pedestrian activity would be between the walkways within the housing development and the usage of public footpath would be relatively low. In view of larger level difference amongst different housing platform, it is anticipated that the majority of pedestrian will rely on the internal lift and footbridge system travelling between the two housing platforms as well as the PTI. For the footpath between the PTI and Shun Tat Street which is anticipated with less demand of pedestrian flow will be narrowed down to 1.5m effective width.

3.5.3 Despite the majority of the pedestrian activities will take place within the proposed developments, external pedestrian connections have been considered. Footpaths along the proposed new access road will be connected to the existing footpath at Shun Tat Street. Two 16-passenger lifts are proposed to link up the proposed developments with Tan Kwai Tsuen area. One-way lift capacity of about 1,370 passenger/hour/direction could be provided by the two passenger lifts. It is anticipated that the capacity would be sufficient to cater for the pedestrian demand between Tan Kwai Tsuen area and the proposed development. A 3.5m wide cautionary crossing, which could accommodate approximate 2100 – 4200 ped/hr for both directions, will be provided at the proposed access road near the passenger lift to provide connection between two sides of footpaths. The existing underpasses beneath Yuen Long Highway will be maintained. One of the underpass is located

near the proposed primary school and the others are located near Shun Tat Street, Tat Fuk Road and Shui Fu Road.

3.5.4 As presented above, it is anticipated that about 84.8% of pedestrian would take public transit. The peak 2-way pedestrian flows to/ from the PTI would be 4,827 ped/hr. As shown in **Table 3.4**, about 8.2% and 29.9% of pedestrian would be commuted on foot to place of work and study, respectively. It is anticipated that the walk trips would mainly be between the development and Tan Kwai Tsuen area via the proposed lifts. For conservative purpose, the peak 2-way pedestrian flows to/ from Tan Kwai Tseun area would be using 29.9% to assess which is the maximum of 1702 ped/hr during PM peak hour. The anticipated level-of-service (LOS) of the proposed footpath is presented in **Table 3.7**.

**Table 3.7 – Capacity of Proposed Footpath**

Footpath <sup>(1)</sup>	Width (m)	Effective Width (m)	Two-way Pedestrian flow (ppl/hr)		(ppl/min/m)		LOS <sup>(5)</sup> <sup>(6)</sup>	
			AM Peak	PM Peak	AM Peak	PM Peak	AM Peak	PM Peak
P1 <sup>(2)</sup>	3.75	2.95 <sup>(3)</sup>	4229	4827	23.9	27.3	C	C
P2	2.5	1.5 <sup>(4)</sup>	1491	1702	16.6	18.9	B	B

Note:

- 1) Location of footpath P1 and P2 refer to **Drawing 3.1**.
- 2) A total width of 7.6m from the kerb to the building will be provided for queuing space and footpath from which a minimum effective width of 2.95m would be maintained for footpath.
- 3) Effective width of footpath is defined as the actual width of footpath by excluding the buffer from the queuing space on one side (i.e. 0.3m) and the likely provision of kerbside railing (i.e. 0.5m);
- 4) Effective width of footpath is defined as the actual width of footpath by excluding the dead width on one side (i.e.0.5m) and the likely provision of kerbside railing (i.e. 0.5m);
- 5) In general, LOS C with a flow rate of 23 – 33 ped/min/m is desirable for most design at streets with dominant “living” pedestrian activities;
- 6) LOS B with a flow rate of 16 - 23 ped/min/m provide sufficient space for pedestrians to freely select their walking speeds, th bypass other pedestrians and to avoid crossing conflicts with others. At this level, pedestrians begin to be aware of other pedestrians and to respond to their presence in the selection of walking paths;

3.5.5 As shown in **Table 3.7**, it revealed that the desirable LOS C or above could be maintained at the proposed footpaths.

### 3.6 Review of Impact on Rail Service

3.6.1 Currently, the MTR Tuen Ma Line (TML) is the only mass transit railway serving northwestern New Territories and provides railway service between Tuen Mun and Kowloon. Apart from the mass transit, the existing Light Rail (LR) transit in the NWNT provides both intra and inter district public transport services for Tuen Mun, Hung Shui Kiu, Tin Shui Wai and Yuen Long districts.

3.6.2 A preliminary assessment on the potential impact on the TML/ LR arising from the proposed Development has been conducted and the findings are presented as follows.



LR Service – Hung Shui Kiu Stop

- 3.6.3 Hung Shui Kiu is an at-grade Light Rail stop located at Castle Peak Road in Yuen Long District, currently served by 4 nos. of Light Rail routes connecting Tuen Mun to Yuen Long.
- 3.6.4 The details of existing Light Rail services at Hung Shui Kiu Stop are summarized in **Table 3.8**.

**Table 3.8 – Existing Light Rail Services at Hung Shui Kiu**

LRT Stop	Route No.	Origin / Destination	Official Service Frequency (min)
Hung Shui Kiu	610	Tuen Mun Ferry Pier ↔ Yuen Long	5 - 9
	614		10 - 17
	615		10 - 18
	751	Tin Yat ↔ Yau Oi	4 - 9

- 3.6.5 Hung Shui Kiu Stop consists of 2 platforms providing 4 LR route services. Platform 1 is the eastward platform to Tin Yat or Yuen Long direction while platform 2 is the westward platform to Tuen Mun Ferry Pier or Yau Oi direction.
- 3.6.6 Based on the service frequency provided by these 4 LR routes in various directions, there are 78 LR vehicles per hour servicing both bounds at Hung Shui Kiu Stop.
- 3.6.7 Making reference to the pedestrian trip generation rate and the modal split described in **Section 3.5**, the passenger trips on TML/ LR generated and attracted by the proposed Development is estimated and presented in **Table 3.9**.

**Table 3.9 – Estimated Rail Service Demand <sup>(1)</sup> (passenger/hr)**

Rail Service	No. of Flat	AM Peak			PM Peak		
		Gen	Att	2-way	Gen	Att	2-way
TML	7,420	1633	227	1860	681	1442	2123
LR		433	60	493	181	383	563

Note:

- 1) The modal split for “to place of work” is adopted for conservative approach to derive the travel demand

- 3.6.8 In view of the passenger demand summarized in **Table 3.9**, it is suggested to the LR passenger demand arising from the proposed Development is 433 at morning peak hour. Assuming all 433 LR passenger demand would be allocated to Hung Shui Kiu Stop for the worst-case scenario, there will be additional 6 passengers assigned onto each LR vehicle during morning peak hour and such additional patronage demand to LR is insignificant even if Hung Shui Kiu Stop would be operating at a level closed to its full capacity.

Tuen Ma Line Service

- 3.6.9 Tin Shui Wai Station is now the nearest existing Tuen Ma Line station to the Site and locates at the eastern edge of HSK area. The construction of the main works of Hung Shui Kiu Station is expected to commence in about 2024 for completion in 2030 and its proposed location is approximately 1.5km away from the Site.
- 3.6.10 According to the Government Replies to LegCo Questions in examining the Estimates of Expenditure 2022-23 ([https:// www.tlb.gov.hk / eng/ legislative/ transport/ special/ land/ THB\(T\)-1-e12022SFC.pdf](https://www.tlb.gov.hk/eng/legislative/transport/special/land/THB(T)-1-e12022SFC.pdf)) regarding the capacity of TML, the critical link of the TML is from Tsuen Wan West to Mei Foo during morning peak. The passenger demand of TML in 2021 is 36,100 per hour per direction which is 61% occupancy (i.e. existing carrying capacity is 58,800 per hour (6 ppsm)).
- 3.6.11 The additional passenger demand induced by the proposed Site at peak hour are summarised in **Table 3.10**.

**Table 3.10– Estimated Demand on Tuen Ma Line at AM Peak Hour**

Number of vehicles per direction	28 trains
Total passenger capacity per direction with 8-car trains.	Around 70,000 <sup>(2)</sup> passengers (6 ppsm) / Around 49,000 passengers (4 ppsm)
Passenger Demand from Proposed Sites	1,633
Ratio of Additional Demand/ Capacity <sup>(1)</sup>	2.33% (6 ppsm) / 3.33% (4 ppsm)

Notes:

- 1) Assuming all passenger demand from proposed site are intended for one direction only for conservative approach (i.e. heading to Hung Hum Station)
- 2) From 2021 Statistics for the Heavy Rail System in THB(T)-1-e12022SFC

- 3.6.12 As shown in **Table 3.10**, the ratio of additional demand over the capacity of future TML is 2.33% based on 6 ppsm / 3.33% based on 4 ppsm only. It is anticipated that the additional demand is relatively insignificant in comparison with the total future demand. In the long term, the Government will timely bid for resources and commence studies for improving the carrying capacity of the railways in NWNT beyond 2031 to cope with the passenger demands.

## 4 TRAFFIC FORECASTING

### 4.1 Design Year

4.1.1 Taking into consideration the 2031 target full population intake, Year 2034, 3 years after the intake of population, is adopted for the traffic and transport impact assessment.

### 4.2 General and Modelling Assumption

4.2.1 Local Area Traffic Model (LATM) would be developed for base year 2021 and design year 2034 to produce traffic forecast. An integrated two-tier modelling approach would be adopted for this Assignment to develop the LATM

4.2.2 The integrated two-tier modelling approach includes the Strategic Transport Model (STM) as the upper tier model and LATM as the lower tier model. The STM is calibrated and validated to base year 2018 based on 2018 planning data from Hong Kong 2030+ Territorial Population and Employment Data Matrix (TPEDM) and will be updated using the latest 2019-based TPEDM planning data for design year 2034. The STM would then be able to provide both the traffic demands to investigate strategic route choices and to generate cordoned matrices for the development of the more detailed LATM.

4.2.3 The latest 2015 Base District Traffic Model (BDTM) NTW1 model developed by TD has been available for the development of the LATM. The NTW1 model covers all critical road junctions within AOI for further assessment.

### 4.3 Traffic Model Methodology for Base Year Model

4.3.1 A 2021 base year LATM is developed for the purpose of the development of design year model. The calibration and validation for the base year LATM development would focus on the checking, updating and enhancement of the traffic model within the AOI to the existing traffic conditions.

4.3.2 In the calibration and validation process, the 2021 initial base year LATM road network and matrices needs to be developed first. The BDTM road network will be reviewed and updated to existing road network to build the LATM initial base year road network. The road network and zones will also be refined as necessary to include more local details within the AOI. The refinement process makes extensive use of the traffic aids drawings, signal plan data sheets, franchised and non-franchised bus routes and schedules as well as site visits.

4.3.3 The LATM initial base year matrices will be derived by applying appropriate zonal growth factor the BDTM matrices. The per annum zonal growth factors are derived from the zonal growth of trips in BDTM between base year and design years. The strategic external-to-external (E-E) trips would be obtained from the STM cordoned matrices. The refinement in the road network details may also lead to the need to further disaggregate the BDTM zone system.

- 4.3.4 The LATM initial base year matrices will then assigned to the LATM initial base year road network. The model flows will be compared with the 2021 traffic counts. The validation includes examination of the modelled flows against the observed flows at the screenlines and critical junctions. Subject to the validation results, the LATM base year road network and LATM base year matrices may require further calibration. The network may require detailed refinements and the matrices will be calibrated using the matrix estimation SATME2 function. SATME2 is a sub-programme within the SATURN suite of programmes that recalculates the origin and destination matrices to give the best overall fit with the observed traffic count data. SATME2 is used to fill in any missing trips in the refined road network as well.
- 4.3.5 Proposed screenlines and junctions identified for validation are as shown in **Figure 4.1**, and they will be used in the calibration and validation process. The model will be validated against the following criteria:
- observed traffic flows crossing the cordon and screenlines; and
  - arm flows comparison at key junctions.
- 4.3.6 The road network and matrices within the study area would be further reviewed and, if necessary, to be refined and recalibrated such that they could reproduce the observed traffic flows in year 2021. The aim of the base year modelling exercise is to validate a base year model against the observed traffic flow such that a robust basis would be available to forecast traffic flows up to the design years 2034.
- 4.3.7 The calibration and validation process continues until the assignment of the matrices reproduces a set of model flows satisfactorily. The checking criterion includes comparison of percentage differences and “Geoffrey E. Havers” (GEH) measure. The GEH is a modified chi squared test, and provides a statistic for both the magnitude of the difference and the percentage difference between the modelled and observed flows. It is used in preference to percentage differences which may over-emphasize differences in relatively small traffic volumes.
- 4.3.8 The BDTM validation criteria would be adopted in the Assignment and are listed in the table below.
- 4.3.9 The following validation criteria as listed below would be adopted:

- BDTM Validation Guidelines

Validation Criteria	Validation Target
Junction Arm Flows and Screenline Link Flows	GEH 5 or less on 85% of links GEH 10 or less on 100% of links
Screenline Link Flows	85% within $\pm 10\%$ 100% within $\pm 20\%$

- 4.3.10 The GEH statistic is a modified chi-square test of the form:

$$\sqrt{\frac{(V_2 - V_1)^2}{\frac{1}{2}(V_1 + V_2)}}$$

Where V1 and V2 are the observed and modelled flows on a specific link.

- 4.3.11 This volumetric assessment will be paralleled by a qualitative examination of the modelled routings between major origins and destinations in the local traffic model areas.
- 4.3.12 The junction and link count validation results are summarised in **Table 4.1** and **Table 4.2** respectively. As indicated in the tables, all the model road links and junctions are within GEH of 10, and as such the validation was completed satisfactorily. Detailed summary of validation results is shown in **Appendix A**.

**Table 4.1 – Summary of Junction Count Validation Result**

Criteria Guideline	Target	Percentage Count Sites within Criteria	
		Morning Peak Hour	Evening Peak Hour
		Total Flow	Total Flow
Total No. of Arms	-	88	88
Comparisons on GEH Values			
No. of Arms GEH < 5	-	78	75
No. of Arms GEH < 10	-	88	88
No. of Arms GEH > 10	-	0	0
% of Arms GEH < 5	85%	89%	85%
% of Arms GEH < 10	100%	100%	100%

**Table 4.2 – Summary of Link Count Validation Result**

Criteria Guideline	Target	Percentage Count Sites within Criteria	
		Morning Peak Hour	Evening Peak Hour
		Total Flow	Total Flow
Total No. of Links	-	10	12
Comparisons on GEH Values			
No. of Links GEH < 5	-	10	12
No. of Links GEH < 10	-	10	12
No. of Links GEH > 10	-	0	0
% of Links GEH < 5	85%	100%	100%
% of Links GEH < 10	100%	100%	100%
Comparisons on Percentage Difference			
No. of Links within ± 10%	-	10	10
No. of Links within ± 20%	-	10	10
No. of Links > ± 20%	-	0	0
% of Links within ± 10%	85%	100%	100%
% of Links within ± 20%	100%	100%	100%

#### 4.4 Traffic Model Methodology for Future Design Years

- 4.4.1 A 2-tier modelling method will be adopted for the traffic forecast of design year 2034. In addition to the 2021 base year matrices, the 2034 cordon matrices will also be obtained from the upper tier STM, which has been calibrated and updated with latest 2019-based TPEDM planning data. Zonal growth factors are then derived from the relevant cordon matrices.
- 4.4.2 The “initial” 2034 and matrices for the LATM are obtained by applying the growth patterns from the cordon matrices of STM to the validated 2021 LATM matrices, such that the growth patterns for the STM would be carried to the LATM. The strategic E-E trips would be obtained from the STM cordoned matrices. The “initial” LATM matrices for year 2034 will be further modified to reflect any changes in the latest planned and committed development in the vicinity.
- 4.4.3 Similarly the networks will also be checked to ascertain whether the known committed traffic measures and infrastructure schemes have been included. The road networks would be updated to reflect the future year’s network assumptions. The future year’s network will be checked to ensure that the latest planned and committed projects are included in the traffic model.
- 4.4.4 In producing future year forecasts, close liaison with the relevant government departments will be held to ensure that the on-going, committed and planned infrastructure and major developments in the study area are included in the traffic model. These infrastructure and developments will be included in the future year traffic forecast for year 2034.
- 4.4.5 The proposed traffic forecasting input assumptions (such as population and employment assumptions, highway and railway network assumptions for the design years, highway toll assumptions etc.) are set out in **Appendix B**.
- 4.4.6 The 2034 reference (i.e. no development at the Site) traffic flows are illustrated in **Figure 4.2**.

#### 4.5 Future Road Network

##### Strategic Planning

- 4.5.1 In addition to the local road network discussed in **Section 3.3**, there will be a few new strategic road links which may improve the site accessibility and enhance the capacity of road links in NWNT in one form, or another. **Table 4.3** summarises the major highway projects geographically close to the project site adopted in this study.

**Table 4.3 – Adopted Major Highway Network Assumption**

New Road Network in New Territories West	Configuration	2031	2036
Road Improvement Works in Hung Shui Kiu New Development Area	D2	✓	✓
Widening of Castle Peak Road – Castle Peak Bay	D2	✓	✓
Tuen Mun Bypass	D2	X	✓
Route 11 including the Lam Tei Tunnel, So Kwun Wat Link, Tai Lam Chung Tunnel and Tsing Lung Bridge	D3	X	✓
Widening of Yuen Long Highway (Section between Lam Tei Quarry and Tong Yan San Tsuen Interchange)	D3	X	✓

Note:

- Route 11 is assumed to be connected to Tuen Mun Road and North Lantau Highway, with connections between Tuen Mun, Tung Chung and Urban

#### Other Major Developments

- 4.5.2 According to the information collected from the relevant government departments, there are two ongoing major public housing developments in the vicinity of the Site, namely Hung Shui Kiu New Development Area (HSK NDA) and Yuen Long South (YLS) Development. While the interfacing issue with YLS Development considered in the Feasibility Stage, had been reviewed and its status including the scope of works and programme remained unchanged, the interfacing issue with HSK NDA in terms of the impact on the local road network was reviewed and discussed in the following section.
- 4.5.3 **Appendix C** shows the planned local road network in phase proposed under CE2/2011 – Hung Shui Kiu New Development Area Planning and Engineering Study. The section of Castle Peak Road between Fuk Hang Tsuen Road and Hung Tin Road mostly remains unchanged as per existing apart from several modification works as summarised and presented as follow,
- Proposed Conceptual Layout of Castle Peak Road / Yick Yuen Road (**Appendix C1**)
  - Proposed Conceptual Layout of Castle Peak Road / Road P1 (**Appendix C2**)
  - Proposed Conceptual Improvement Scheme of Castle Peak Road / Fuk Hang Tsuen Road (**Appendix C3**)
- 4.5.4 It is anticipated that the development traffic would not be make use of Yick Yuen Road or Road P1, thus the junctions of Castle Peak Road / Yick Yuen Road and Castle Peak Road / Road P1 have not been considered as critical junctions and will not be assessed in detail. Whereas the junction improvement works of Castle Peak Road/ Fuk Hang Tsuen Road proposed under HSK NDA study has also been taken into account of

consideration and the interfacing issue will be discussed further in **Section 5.4**.

## 4.6 Development Traffic Generations

4.6.1 The Sites' trip generations will be added to the design years LATM matrices to produce the traffic flow assignments under the development scenario. The growth between the base year 2021 and future year 2034 will be checked against the base year flows to ensure that such change and growth are reasonable and are commensurate with the change in the road network and development data.

4.6.2 In order to estimate the traffic generation of the proposed Development, reference have been made to latest trip generation and attraction rates as extracted from Transport Planning and Design Manual (TPDM). The adopted trip rates are summarized in **Table 4.4**.

**Table 4.4 – Adopted Trip Rate for the Proposed Development**

Reference	Adopted Trip Rates			
	AM Peak		PM Peak	
	Generation	Attraction	Generation	Attraction
TPDM (PRH) (Average Flat Size: 40m <sup>2</sup> ) <sup>(1)</sup> (pcu/hr/flat)	0.0432	0.0326	0.0237	0.0301
TPDM (SSF) (Average Flat Size: 50m <sup>2</sup> ) <sup>(1)</sup> (pcu/hr/flat)	0.0622	0.0426	0.0297	0.0401
Welfare (pcu/hr/100m <sup>2</sup> GFA) <sup>(2)</sup>	0.1703	0.2452	0.1573	0.1175
Kindergarten (pcu/classroom) <sup>(3)</sup>	1.6429	1.6429	0.9286	0.9286
Primary School (pcu / classroom) <sup>(4)</sup>	1.3462	1.3846	0.6154	0.6154
Retail (pcu/hr/100m <sup>2</sup> GFA) <sup>(5)</sup>	0.2296	0.2432	0.3100	0.3563
Office (pcu/hr/100m <sup>2</sup> GFA) <sup>(5)</sup>	0.1703	0.2452	0.1573	0.1175

Sources:

- (1) TPDM Volume 1, Chapter 3, Appendix, Table 1
- (2) Trip rates for Welfare Facilities are based on "Office" from TPDM Volume 1, Chapter 3, Appendix, Table 2
- (3) Trip rates for Kindergarten are based on in-house database
- (4) TD 05/2006 Trip Generation Survey 2006 Report  
Table 6.9 primary school in New Territories West
- (5) TPDM Volume 1, Chapter 3, Appendix, Table 2

4.6.3 Based on the latest development parameters as listed in **Table 3.1** and the adopted trip rates as shown in **Table 4.4**, the total traffic generations of the proposed housing Development and proposed public transport services are computed and summarized in **Table 4.5** to **Table 4.7** respectively.

**Table 4.5 – Traffic Generation for the Proposed Housing Development**

Proposed Land Use	Flat Nos.	Traffic Generations (pcu/hr)			
		AM Peak		PM Peak	
		Generation	Attraction	Generation	Attraction
PRH	5,450 flats	236	178	130	165



Proposed Land Use	Flat Nos.	Traffic Generations (pcu/hr)			
		AM Peak		PM Peak	
		Generation	Attraction	Generation	Attraction
SSF	1,970 flats	123	84	59	79
Sub-total		<u>359</u>	<u>262</u>	<u>189</u>	<u>244</u>
Retail	5,912m <sup>2</sup> GFA	14	15	19	22
Welfare	15,856m <sup>2</sup> GFA	27	39	25	19
Kindergarten	15 classrooms	25	25	14	14
Primary School	30 classrooms	41	42	19	19
Office <sup>(1)</sup>	1,098m <sup>2</sup> GFA	2	3	2	2
<b>Total</b>		<b>465</b>	<b>386</b>	<b>268</b>	<b>320</b>

(1) Ancillary facilities such as District Councillor's Office and Estate Management Office, etc. are considered as office uses for conservative estimate of the traffic impact.

**Table 4.6 – Traffic Generation for the Proposed Public Transport Interchange**

PT Mode	No. of Route	Frequency	No. of Bus/GMB per hour	Traffic Generations (pcus/hr)			
				AM Peak		PM Peak	
				Generation	Attraction	Generation	Attraction
Bus	5	5-15 minutes	37	95	95	95	95
Green Minibus <sup>(1)</sup>	1	6 minutes	10	15	15	15	15
<b>Total</b>				<b>110</b>	<b>110</b>	<b>110</b>	<b>110</b>

Note: 1. For conservative approach, a green minibus route with 6 minutes frequency have been assumed.

**Table 4.7 – Estimated Traffic Generation for the Proposed Development**

Site	Traffic Generations (pcus/hr)			
	AM Peak		PM Peak	
	Generation	Attraction	Generation	Attraction
The Development near TKT	<b>575</b>	<b>496</b>	<b>378</b>	<b>430</b>

4.6.4 As shown in **Table 4.7**, it is estimated that the proposed Development will generate and attract about 575 pcu/hr and 496 pcu/hr in the AM peak hour and generate and attract about 378 pcu/hr and 430 pcu/hr in the PM peak hour respectively under the current proposed development parameters. The development traffic flows along the affected road network is shown in **Figure 4.3**.

## 4.7 Design Traffic Forecasts

4.7.1 As mentioned in **Section 4.1**, year 2034 is adopted as the design year of this study. The year 2034 design traffic forecast (with development) is shown in **Figure 4.4**.

## 5 OPERATIONAL TRAFFIC IMPACT ASSESSMENT

### 5.1 Overview

5.1.1 Traffic forecasts were developed for design year 2034. The operational TTIA would identify the critical issues and recommend any associated traffic improvement schemes to alleviate the identified traffic problem as necessary.

### 5.2 Critical Junction Assessment

5.2.1 It was understood that TD has proposals of modification works for three junctions along Castle Peak Road in Hung Shui Kiu, including Castle Peak Road – Hung Shui Kiu / Hung Tak Road (J2), Castle Peak Road – Hung Shui Kiu / Tan Kwai Tsuen Road (J3) and Castle Peak Road – Hung Shui Kiu / Shun Tat Street (J5). The layouts of the proposed improvement works are shown in **Appendix D1, D2** and **D3** respectively. It is anticipated that TD’s proposed improvement works would be in place by 2034 and they had been taken into consideration in the junction assessment.

5.2.2 Under CE2/2011, it is proposed to modify the traffic lanes configuration to optimize the junction performance by converting the Castle Peak Road southbound left-turn-only lane to straight-ahead-and-left-turn shared lane as illustrated in **Appendix C3**. According to the HSK NDA latest available information, the junction improvement works to J8 will be implemented by 2026 when the first stage of phased intake. The planned junction improvement by HSK NDA had been taken into consideration in the junction assessment.

5.2.3 The junction assessment result based on the forecasted peak hour traffic flows are summarized in **Table 5.1**.

**Table 5.1 – 2034 Junction Assessment**

Ref.	Junction	Method of Control	RC/DFC <sup>(1)</sup>			
			2034 Reference Case		2034 Design Case	
			AM	PM	AM	PM
J1	Hung Tin Road / Hung Chi Road	Signal	30%	28%	24%	25%
J2	Castle Peak Road – Hung Shui Kiu / Hung Tak Road <sup>(2)</sup>	Signal	69%	>100%	47%	83%
J3	Castle Peak Road – Hung Shui Kiu / Tan Kwai Tsuen Road <sup>(2)</sup>	Signal	47%	66%	32%	59%
J4	Tan Kwai Tsuen Road / Hung Shun Road	Priority	0.50	0.39	0.69	0.53
J5	Castle Peak Road – Hung Shui Kiu / Shun Tat Street <sup>(2)</sup>	Signal	24%	17%	-10%	-8%
J6	Shun Tat Street / Tat Fuk Road	Priority	0.06	0.04	0.20	0.16
J7	Shun Tat Street / Tung Fuk Road <sup>(3)</sup>	Signal	>100%	>100%	41%	70%
J8	Castle Peak Road – Lam Tei / Fuk Hang Tsuen Road <sup>(4)</sup>	Signal	-5%	-1%	-12%	-8%

Ref.	Junction	Method of Control	RC/DFC <sup>(1)</sup>			
			2034 Reference Case		2034 Design Case	
			AM	PM	AM	PM
J9	Castle Peak Road – Hung Shui Kiu / Hung Tin Road	Signal	27%	42%	27%	42%
J10	Tan Kwai Tsuen Road/ Shui Fu Road	Priority	0.17	0.12	0.44	0.17
J11	Tin Shui Wai West Interchange	Round-about	0.80	0.92	0.86	0.97
J12	Shui Fu Road / Proposed Access Road <sup>(5)</sup>	Signal	>100%	>100%	17%	86%

Note:

(1) RC = Reserve Capacity for Signal-Controlled Junction, DFC = Design Flow to Capacity for Priority Junction and Roundabout

(2) Based on TD's planned improvement works (Appendix D1, D2 & D3 for J2, J3 & J5 respectively)

(3) Based on Proposed Junction Improvement (Figure No. 3.2)

(4) Based on Proposed Junction Improvement under CE2/2011 (Appendix C3)

(5) Based on Proposed Junction Improvement (Figure No. 3.5)

5.2.4 The assessment results indicate that all the critical junctions would be operated within their capacities except J5 – Castle Peak Road – Hung Shui Kiu / Shun Tat Street and J8 – Castle Peak Road – Lam Tei / Fuk Hang Tsuen Road would be operated over its capacities in year 2034.

### 5.3 Road Capacity Assessment

5.3.1 **Table 5.3** summarizes the traffic forecasts and V/C ratio assessments for year 2034.

**Table 5.2 – Road Links Capacity Assessment for Design Year 2034**

Ref.	Road	Direction (No. of lanes)	Capacity (pcu/hr)	2034 Reference Case				2034 Design Case			
				(Figure 4.2)				(Figure 4.4)			
				Traffic Flow (pcu/hr)		V/C Ratio		Traffic Flow (pcu/hr)		V/C Ratio	
				AM	PM	AM	PM	AM	PM	AM	PM
J11	Slip Road from Yuen Long Highway (WB) to Hung Tin Road (NB)	NB (1)	1,800 <sup>(5)</sup>	1,875	2,150	1.04	1.19	2,015	2,265	1.12	1.26
	Slip Road from Yuen Long Highway (EB) to Hung Tin Road (NB)	NB (1)	1,800 <sup>(5)</sup>	1,150	1,485	0.64	0.83	1,150	1,485	0.64	0.83
	Slip Road from Hung Tin Road (SB) to Yuen Long Highway (EB)	EB (1)	1,800 <sup>(5)</sup>	1,800	1,430	1.00	0.79	1,915	1,510	1.06	0.84
	Slip Road from Hung Tin Road (SB) to Yuen Long Highway (WB)	WB (1)	1,800 <sup>(5)</sup>	2,140	2,040	1.19	1.13	2,140	2,040	1.19	1.13
L1	Yuen Long Highway – Tin Shui Wai	EB (3)	6,110 <sup>(2)</sup>	6,795	7,090	1.11	1.16	6,910	7,170	1.13	1.17
		WB (3)	6,110 <sup>(2)</sup>	6,245	6,135	1.02	1.00	6,385	6,250	1.05	1.02
L2	Hung Tin Road	NB (2)	3,600 <sup>(1)</sup>	3,090	3,685	0.86	1.02	3,255	3,805	0.90	1.06
		SB (2)	3,600 <sup>(1)</sup>	3,770	3,315	1.05	0.92	3,885	3,395	1.08	0.94
L3	Castle Peak Road – Hung Shui Kiu	EB (2)	2,860 <sup>(3)</sup>	1,240	1,255	0.43	0.44	1,330	1,325	0.47	0.46
		WB (2)	2,860 <sup>(3)</sup>	845	995	0.30	0.35	945	1,035	0.33	0.36
L4	Shun Tat Street	NB (1)	1,055 <sup>(4)</sup>	235	210	0.22	0.20	530	440	0.50	0.42
		SB (1)	1,055 <sup>(4)</sup>	220	245	0.21	0.23	470	465	0.45	0.44
-	New Slip Road Connection to TSWWI	EB (1)	1,800 <sup>(5)</sup>	100	40	0.06	0.02	265	160	0.15	0.09
		WB (1)	1,800 <sup>(5)</sup>	75	45	0.04	0.02	215	160	0.12	0.09

Notes:

- (1) Based on TPDM Volume 2 Chapter 2.4, peak hourly design flow for dual 2 lane expressway/trunk road is 3000 veh/hr per one direction of flow. Take pcu factor as 1.3, the link capacity is 3900 pcu/hr. For district distributor at Hung Tin Road, 0.9 factor is applied to reflect the lowered class of road hierarchy, i.e. 3600 pcu/hr.
- (2) Based on TPDM Volume 2 Chapter 2.4, peak hourly design flow for dual 3 lane expressway is 4700 veh/hr per one direction of flow. Take pcu factor as 1.3, the link capacity is 6110 pcu/hr.
- (3) Based on TPDM Volume 2 Chapter 2.4, peak hourly design flow for dual 4 lane district distributor (with frontage, bus stops and pedestrian crossings) undivided carriageway is 2000 veh/hr per one direction of flow. With reference to difference in design flow between undivided carriageway and dual carriageway of primary distributor, 200 veh/hr design flow is added to undivided carriageway arrangement, i.e. 2200 veh/hr design flow per one direction of flow of dual carriageway is adopted. Take pcu factor as 1.3, the link capacity is 2860 pcu/hr.
- (4) Based on TPDM Volume 2 Chapter 2.4, peak hourly design flow for 2 lane 10m width undivided carriageway is 2200 veh/hr for both direction of flow. For local road type at Shun Tat Street, 0.8 factor is applied to reflect the lowered class of road hierarchy, i.e. 1760 veh/hr 2-way. Take local road pcu factor as 1.2, the link capacity is 2110 pcu/hr, 2-way, i.e. 1055 pcu/hr per direction.
- (5) 1800 pcu/hr link capacity for one lane slip road is adopted for consistency amongst other projects.

5.3.2 The assessment results indicated that most of the road links are expected to operate with V/C ratios below 1 except Slip Road from Hung Tin Road (SB), Yuen Long Highway – Tin Shui Wai and Hung Tin Road which will operate at V/C ratios above 1.0 but below 1.2 in year 2034, indicating a situation of overloading and a manageable degree of congestion and Slip Road from Yuen Long Highway (WB) which will operate at V/C ratios above 1.2 indicating more serious congestion with traffic speeds deteriorating progressively with further increase in traffic. With reference to the Yuen Long South Development – Design and Construction TTIA Review Paper, the V/C ratio of slip roads and road links at Tin Shui Wai West Interchange / Yuen Long Highway will be relieved in 2036 after the planned improvements are in place such that

the V/C ratio will be within 1.0. The traffic impact on these strategic roads due to the development should be timely reviewed in subsequent stages of the project in conjunction with other traffic/transport infrastructure studies conducted by the Government.

## 5.4 Proposed Improvement Scheme

5.4.1 According to the junction performance result in **Table 5.2**, the junction of Castle Peak Road – Hung Shui Kiu / Shun Tat Street (J5) and Castle Peak Road – Lam Tei / Fuk Hang Tsuen Road (J8) will be exceeded or operated closed to capacity. Hence, junction improvement measures are proposed and describes below.

### Proposed Junction Improvement at Castle Peak Road – Hung Shui Kiu / Shun Tat Street (J5)

5.4.2 As discussed in Para. 3.3.5, it is proposed to modify the layout of Castle Peak Road / Shun Tat Street to provide a right turning movement from Shun Tat Street to allow traffic access to Yuen Long direction. The proposed junction layout and method of control are shown in **Figure 3.4**.

### Proposed Junction Improvement at Castle Peak Road – Lam Tei / Fuk Hang Tsuen Road (J8)

5.4.3 It is proposed to widen the approach arm of Fuk Hang Tsuen Road (NB) to provide one additional “turn-left” lane in addition to modify the existing uncontrolled cautionary pedestrian crossing across Fuk Hang Tsuen Road to be signal-controlled. The details of junction design are shown in **Figure 5.1**. As suggested by the overlay of private land lot plan, the proposed improvement scheme does not required resumption of private land. The above improvement work will be carried out by Highways Department under 852TH - Widening of Fuk Hang Tsuen Road (between Castle Peak Road – Lam Tei and Fuk Hang Tsuen Lane). According to LC Paper No. CB(4)254/2022(04), the proposed works will be commenced upon obtaining funding approval from the Finance Committee for target completion in around 2.5 years. It is anticipated that the planned improvement works will be completed before the population intake of the proposed Development. The concerned party shall be closely liaised with to ensure that the proposed improvement works shall be completed before population intake.

5.4.4 The operational performance of the junction was reassessed based on the proposed junction improvement works, and the results are summarized in **Table 5.3**.

**Table 5.3 – Junction Performance under Proposed Improvement Scheme**

Ref.	Junction	Method of Control	2034 Reference Case		2034 Design Case	
			AM	PM	AM	PM
J5	Castle Peak Road – Hung Shui Kiu / Shun Tat Street (refer to Figure 3.4)	Signal	97%	86%	16%	20%
J8	Castle Peak Road – Lam Tei / Fuk Hang Tsuen Road (refer to Figure 5.1)	Signal	24%	25%	16%	17%

- 5.4.5 As shown in **Table 5.3**, the junctions Castle Peak Road – Hung Shui Kiu / Shun Tat Street (J5) and Castle Peak Road – Lam Tei / Fuk Hang Tsuen Road (J8) after improvement could operate with adequate capacity (i.e.  $\geq 10\%$  R.C.) with the proposed improvement schemes in place. It is understood that further junction improvement scheme at the junction of Castle Peak Road – Hung Shui Kiu / Shun Tat Street will be implemented by an adjacent planned brownfield project and the junction is anticipated to be operated with satisfied capacity.

## 5.5 Construction Traffic Impact

- 5.5.1 The major construction traffic generation from the proposed Development during construction are mainly from site formation cut/fill works, transporting the construction/ demolition materials and etc. According to the latest construction programme, it is estimated that the peak construction traffic generated from the proposed Development will generate and attract 10 pcu/hr and 30 pcu/hr in AM and PM peak respectively (i.e. 40 pcu/hr 2 -way traffic) in design year 2025/2026.
- 5.5.2 The excavated materials generated from the site formation works may be stockpiled at the vacant lands adjacent to the TKT North Fresh Water Service Reservoir prior to the commissioning of Proposed Access Road connected the Site to TSWWI which is anticipated to be completed in year 2031. When the Proposed Access Road in place, it is assumed that the construction traffic will be transported to the available public fill reception facilities via Yuen Long Highway in order to minimize the traffic impact on the existing local roads connecting to Castle Peak Road. The proposed construction traffic routing is shown on **Figure 5.2**.
- 5.5.3 According to the traffic assessment results in 2034 for both junctions and road links with the Proposed Development trip generation in **Tables 5.2** and **5.3**, most of the junctions and road links (i.e. Yuen long Highway) would still have adequate capacity to handle the development trips (i.e. 1070 pcu/hr, two-way in AM Peak & 810 pcu/hr, two-way in PM Peak) during both AM and PM peak hours. Considering the relatively low volume of construction traffic generated by the proposed Development as mentioned above, it is anticipated that no insurmountable impact on the existing road network due to the proposed Development during construction stage in 2025/26.

## 5.6 Sensitivity Study for Phases 1 & 2 Intake in 2030

- 5.6.1 A sensitivity study for Phases 1 and 2 intake (around 60% of the total population intake and without connection between proposed access road and Tin Shui Wai West Interchange) in 2030 has been carried out. By using the same model methodology as stated in Section 4, the year 2030 reference (without development) and design traffic forecast (with development) are shown in **Figures 5.4** and **5.5**, respectively.
- 5.6.2 It is estimated that Phases 1 and 2 will generate and attract about 443 pcu/hr and 396 pcu/hr in the AM peak hour and generate and attract about 306 pcu/hr and 338 pcu/hr in the PM peak hour respectively as shown in **Table 5.4** under the current proposed development parameters as stated in Section 4.

**Table 5.4 – Estimated Traffic Generation for the Proposed Development in 2030**

Site	Traffic Generations (pcu/hr)			
	AM Peak		PM Peak	
	Generation	Attraction	Generation	Attraction
Total Traffic Generation upon full intake as presented in Table 4.7	575	496	378	430
Estimated Phase 3 development traffic (3,050 flats)	132	100	72	92
Traffic Generation from Phases 1 and 2 development	443	396	306	338

5.6.3 The junction assessment result based on the forecasted peak hour traffic flows are summarized in **Table 5.5**.

**Table 5.5 – 2030 Junction Assessment**

Ref.	Junction	Method of Control	RC/DFC <sup>(1)</sup>			
			2030 Reference Case		2030 Design Case	
			AM	PM	AM	PM
J1	Hung Tin Road / Hung Chi Road	Signal	43%	45%	36%	38%
J2	Castle Peak Road – Hung Shui Kiu / Hung Tak Road <sup>(2)</sup>	Signal	75%	>100%	43%	78%
J3	Castle Peak Road – Hung Shui Kiu / Tan Kwai Tsuen Road <sup>(2)</sup>	Signal	55%	70%	32%	55%
J4	Tan Kwai Tsuen Road / Hung Shun Road	Priority	0.48	0.38	0.72	0.56
J5	Castle Peak Road – Hung Shui Kiu / Shun Tat Street <sup>(2)</sup>	Signal	36%	31%	-3%	0%
J6	Shun Tat Street / Tat Fuk Road	Priority	0.05	0.04	0.20	0.17
J7	Shun Tat Street / Tung Fuk Road <sup>(3)</sup>	Signal	>100%	>100%	39%	68%
J8	Castle Peak Road – Lam Tei / Fuk Hang Tsuen Road <sup>(4)</sup>	Signal	6%	10%	-2%	3%
J9	Castle Peak Road – Hung Shui Kiu / Hung Tin Road	Signal	28%	49%	16%	36%
J10	Tan Kwai Tsuen Road/ Shui Fu Road	Priority	0.16	0.12	0.38	0.17
J12	Shui Fu Road / Proposed Access Road <sup>(5)</sup>	Signal	>100%	>100%	>100%	>100%

Note:

(1) RC = Reserve Capacity, DFC = Design Flow to Capacity

(2) Based on TD's planned improvement works (Appendix D1, D2 & D3 for J2, J3 & J5 respectively)

(3) Based on Proposed Junction Improvement (Figure No. 3.2)

(4) Based on Proposed Junction Improvement under CE2/2011 (Appendix C3)

(5) Based on Proposed Junction Improvement (Figure No. 3.5)

5.6.4 The assessment results indicate that all the critical junctions would be operated within their capacities except J5 – Castle Peak Road – Hung Shui Kiu / Shun Tat Street and J8 Castle Peak Road – Lam Tei / Fuk Hang Tsuen Road would be operated over



its capacities in year 2030 without Phase 3 and without the connection with Tin Shui Wai West Interchange.

- 5.6.5 The junction improvement scheme of J5 and J8 as mentioned on the above section will also be proposed in order to enhance the junction capacity in 2030.
- 5.6.6 The operational performance of the junction was reassessed based on the proposed junction improvement works, and the results are summarized in **Table 5.3**.

**Table 5.6 – Junction Performance under Proposed Improvement Scheme**

Ref.	Junction	Method of Control	2030 Reference Case		2030 Design Case	
			AM	PM	AM	PM
J5	Castle Peak Road – Hung Shui Kiu / Shun Tat Street (refer to Figure 3.4)	Signal	>100%	>100%	19%	27%
J8	Castle Peak Road – Lam Tei / Fuk Hang Tsuen Road	Signal	39%	40%	29%	31%

- 5.6.7 As shown in **Table 5.3**, both J5 and J8 could operate with adequate capacity with the proposed improvement schemes in place.
- 5.6.8 For the affected road links, the V/C ratios are expected to be similar to the results of design year 2034 which most of the road links will operate with V/C ratios below 1.0 except the slip roads to/from Yuen Long Highway and Yuen Long Highway – Tin Shui Wai and Hung Tin Road which will operate at V/C ratios above 1.0 but below 1.2, indicating a situation of overloading and a manageable degree of congestion.

## 6 CONCEPTUAL TEMPORARY TRAFFIC MANAGEMENT SCHEMES (TTMS)

### 6.1 Proposed Works

6.1.1 As discussed in previous section, junction improvement works are proposed at the junction of Castle Peak Road – Hung Shui Kiu / Shun Tat Street (J5), Shun Tat Street / Proposed Access Road / Tung Fuk Road (J7), Castle Peak Road – Lam Tei / Fuk Hang Tsuen Road (J8) and Shui Fu Road / Proposed Access Road (J12) as shown in **Figure 3.4, 3.2, 5.1 and 3.5** respectively.

### 6.2 Basic Design Principles for TTMS

6.2.1 This report only presents the conceptual TTMS. Detailed arrangement and associated impact assessment should be discussed and approved by the Traffic Management Liaison Group (TMLG) later during the construction stage.

6.2.2 The design of detailed TTMS by the awarded contractor will fully comply with the requirements as stipulated in the Transport Planning and Design Manual (TPDM) and the “Code of Practice for the Lighting, Signing and Guarding of Road Works” by Highways Department (HyD). Subject to the site condition, the design of TTMS will also take into account the below principles:

- Whenever possible, the construction works will be carried out during the daytime to shorten the construction period, and thus minimize the implementation period of the TTMS.
- Traffic capacity will be maintained at a reasonable level in order to avoid serious congestion and queue-back problems along roads and junctions affected by the construction works.
- The existing footpath will be maintained as far as possible to prevent blockage of existing pedestrian route. If blockage of footpath is unavoidable and a 1.5 m footpath cannot be maintained, clear indication and signage showing the diverted route will be provided.
- Appropriate lighting, signing and guarding will be provided if necessary.
- Road safety will be the first priority throughout the construction period. The proposed TTA schemes will ensure that the potential risk of accident arising from the roadworks is minimized.
- The excavated trenches near footpaths will be guarded by temporary railings, lighting and with appropriate signing at all times from the safety point of view. The guarding and signing of the footpath will follow the requirements stated in the “Code of Practice for the Lighting, Signing and Guarding of Road Works” by HyD. In any circumstances, a minimum width of 3.5 m along the carriageway will be maintained during construction.
- Under any circumstances, excavation / construction works will not cause obstruction to nearby fire hydrants and the associated valves. Relocation / temporary shutdown of fire hydrants will only be implemented with prior consent from the Fire Services Department.

- All temporary traffic signs will not obstruct the sightline of drivers.
- For the TTMS in the vicinity of schools, treatment plants, racecourses, private roads, bus stops, private lands, ingress / egress, etc., advanced liaison and consent from the affected stakeholders will be carried out prior to implementation of the TTA schemes.
- Any necessary alternation of street furniture, traffic signs, road markings, etc. will be reinstated to its original condition upon completion of the proposed works.
- Vehicular access for emergency vehicles will be maintained.
- The length of work fronts will be determined based on the results of trial runs, if necessary, and prevailing traffic conditions.
- The TTMS will be released by Contractor upon the request by the Road Management Office (RMO) of the Hong Kong Police Force (HKPF) and the Transport Department (TD) in case of any emergency.
- In some special cases (such as cases involving complex urban road junctions and space constraints on roads) where the actual site condition does not warrant the implementation of the above measures, the relevant Government departments / stakeholders will be consulted to develop alternative temporary traffic arrangements and to strengthen the temporary traffic control measures to enhance the overall safety of the works after taking into consideration the site conditions.

### 6.3 Conceptual TTMS

#### TTMS for Junction Improvement Works at Castle Peak Road – Hung Shui Kiu / Shun Tat Street (J5) (Figures 6.1 to 6.4)

- 6.3.1 The junction modification works will be implemented in four stages. Stage 1 involves footpath and road widening works. Stage 2 involves construction of cycle track. Stage 3 involves modification of central divider. During Stages 1 to 3, a traffic lane at Castle Peak Road – Hung Shui Kiu southbound will be temporarily closed during off-peak hours as loading / unloading area and a minimum 4m wide traffic lane will be maintained. Stage 4 involves modification of central divider at the northbound and between the two bounds. One traffic lane at each of the Castle Peak Road – Hung Shui Kiu northbound and southbound will be temporarily closed during off-peak hours as loading / unloading area. The TTMS is subject to comments from/agreements of the relevant departments including the TD and the RMO of HKPF prior to the actual commencement of works on site.

#### TTMS for Junction Improvement Works at Shun Tat Street / Proposed Access Road / Tung Fuk Road (J7) (Figures 6.5 to 6.7)

- 6.3.2 The junction modification works will be implemented in three stages. Stage 1 involves road widening works along Shun Tat Street westbound. Section of footpath will be temporarily closed and pedestrian will be diverted to use opposite footpath. Stage 2 involves construction of Proposed Access Road and the run-in/ out of the existing NWNT RTS will be relocated to Shun Tat Street at the east of Proposed

Access Road. Stage 3 involves road widening works along Shun Tat Street westbound and Tung Fuk Road southbound. Existing traffic lane width will be maintained. The TTMS is subject to comments from/agreements of the relevant departments including the TD and the RMO of HKPF prior to the actual commencement of works on site.

TTMS for Junction Improvement Works at Castle Peak Road – Lam Tei / Fuk Hang Tsuen Road (I8) (Figures 6.8 to 6.10)

- 6.3.3 The junction modification works will be implemented in three stages. Stage 1 involves footpath widening works at Fuk Hang Tsuen Road eastbound. Stage 2 involves road widening works at Fuk Hang Tsuen Road eastbound. The existing traffic lane width at Fuk Hang Tsuen Road will be maintained. Stage 3 involves modification of central divider at Castle Peak Road – Lam Tei and road widening works at Fuk Hang Tsuen Road westbound. One traffic lane at Castle Peak Road – Lam Tei southbound will be occupied during off-peak hours as loading / unloading area. The TTMS is subject to comments from/agreements of the relevant departments including the TD and the RMO of HKPF prior to the actual commencement of works on site.

TTMS for Junction Improvement Works at Shui Fu Road / Proposed Access Road (I12) (Figures 6.11 to 6.12)

- 6.3.4 The junction modification works will be implemented in two stages. Stage 1 involves construction of footpath and pedestrian crossing, connection with proposed access road and painting of road markings at Shui Fu Road. One traffic lane at Shui Fu Road will be closed for 24 hours in sub-stages to facilitate the maneuvering of long vehicles and one-lane two-way traffic management will be implemented. Stage 2 involves the construction of pedestrian crossing and painting of road markings on the other bound of Shui Fu Road. One traffic lane at Shui Fu Road will be closed for 24 hours in sub-stages to facilitate the maneuvering of long vehicles and one-lane two-way traffic management will be implemented. The TTMS is subject to comments from/agreements of the relevant departments including the TD and the RMO of HKPF prior to the actual commencement of works on site.

## 7 SUMMARY AND CONCLUSION

### 7.1 Summary

7.1.1 The main objectives of this Traffic and Transport Impact Assessment (TTIA) Report are to assess the potential traffic impact arising from the increase of total maximum plot ratios from 6.5 to 7.0 (i.e. domestic PR of 6.5 and non-domestic PR of 0.5) for Phase 1, 6.5 to 7.2 (i.e. domestic PR of 6.5 and non-domestic PR of 0.7) for Phase 2 and 6.5 to 7.3 (i.e. domestic PR of 6.5 and non-domestic PR of 0.8) for Phase 3 respectively and review and update the previously approved TTIA report.

#### Proposed Development Parameters

7.1.2 The latest development parameters of the proposed Development are summarized in **Table 3.1**.

7.1.3 The car parking and loading/unloading provisions for the proposed public housing development will follow the requirements as stipulated in the latest Hong Kong Planning Standard and Guidelines (HKPSG).

7.1.4 To meet the increasing parking demand in the territory, it is recommended to adopt the high-end of the HKPSG parking and loading/ unloading provision.

#### Local Road Network

7.1.5 A new single 2-lane access road running along and parallel to the eastern side of Yuen Long Highway is proposed to provide external connection to the proposed Development. A proposed public access road between the upper and lower platforms will form a junction with the single 2-lane access road parallel to Yuen Long Highway in the form of a roundabout. The proposed local road networks are shown in **Figure 3.1**.

7.1.6 This proposed access road will connect to the existing Shun Tat Street at its southern end near the existing NWNT RTS to provide primary access to Castle Peak Road – Hung Shui Kiu for the Site. Due to the site constraints imposed by the existing NWNT RTS and Yuen Long Highway, the junction of Shun Tat Street / Tung Fuk Road (J7) will be modified in the form of a signalized junction to accommodate the traffic flow generated by the proposed Development. A separate working paper will be prepared to discuss and address the interface issue of the NWNT RTS.

7.1.7 In addition to the abovementioned provision of an at-grade access to Castle Peak Road, it is proposed to extend the proposed access road northwards to connect with the existing slip road at TSWWI to provide a secondary access for the Site. Under such arrangement, the Development traffic would gain access to Yuen Long Highway for accessing Yuen Long and Tin Shui Wai areas. Apart from the above, this connection can also serve as an alternative access for the Development, should there be any incident occur along the access between Castle Peak Road – Hung Shui Kiu and the Site.

7.1.8 In order to further improve the connectivity between the proposed Development and the surrounding areas, it is proposed to connect the proposed access road with the existing Shui Fu Road at the “Hairpin” turn adjacent to the existing Tan Kwai Tsuen North Fresh Water Service Reservoir. This alternative access to Castle Peak Road – Hung Shui Kiu via Shui Fu Road and Tan Kwai Tsuen Road could also enhance the accessibility to the Tan Kwai Tsuen local villages and Hung Shui Kiu Light Rail Station.

Proposed Junction Improvement Works

- Junction of Shun Tat Street / Tung Fuk Road (J7)

7.1.9 Due to the site constraints imposed by the existing NWNT RTS and Yuen Long Highway, the junction of Shun Tat Street / Tung Fuk Road (J7) will be modified in the form of signal control to accommodate the traffic flow generated by the proposed Development. The proposed junction layout with corresponding method of control are illustrated in **Figure 3.2**.

- Junction of Castle Peak Road/ Shun Tat Street (J5)

7.1.10 With the aim to serve the Site as a primary site access route, it is proposed to modify the layout of junction of Castle Peak Road/ Shun Tat Street (J5) to provide a right turning movement from Shun Tat Street to allow traffic access to Yuen Long direction by making minor change to the existing method of control. The proposed junction layout with the corresponding method of control are illustrated in **Figure 3.4**.

- Junction of Shui Fu Road/ Proposed Access Road (J12)

7.1.11 In order to further improve the public accessibility to the proposed GIC facilities and PTI at the Site, CEDD proposed to connect the new access road with the existing Shui Fu Road. Such proposal had not been considered at the Feasibility Study. Upon review, it is proposed to connect the new access road with the existing Shui Fu Road at its “Hairpin” turn adjacent to the existing Tan Kwai Tsuen North Fresh Water Service Reservoir.

7.1.12 **Figure 3.5** shows the proposed layout design of junction of Shui Fu Road/ Proposed Access Road (J12) including MOC plan. The proposed junction design will be able to accommodate the turning movement to/ from Shui Fu Road. The section of footpath along the uphill direction near the “Hairpin” turn of Shui Fu Road is proposed to be omitted and re-provided to the opposite side to further connect with the proposed footpath along the proposed access road.

- Junction of Castle Peak Road/ Fuk Hang Tsuen Road (J8)

7.1.13 It is proposed to widen the approach arm of Fuk Hang Tsuen Road (NB) to provide one additional “turn-left” lane in addition to modify the existing cautionary pedestrian crossing across Fuk Hang Tsuen Road to signal control. The details of junction design are shown in **Figure 5.1**.

Public Transport Facilities/Services

- 7.1.14 Based on the estimated public transport demand, an off-street conventional parallel bay design public transport interchange (PTI) with a minimum of 1 double width bus bay and 4 single width bus bays is proposed subject to actual bus route planning at a later stage in order to ensure a comprehensive coverage of the public transport services for the proposed Development.
- 7.1.15 Based on further discussion with TD and to further enhance the public transport services, a total of 5 terminating bus bays, 1 en-route bus bay, a green minibus stand and a taxi stand will be provided within the PTI..

Traffic Forecasting

- 7.1.16 The Local Area Model (LAM) was developed/validated to produce future traffic forecasts in year 2034 for the operational traffic impact assessment.
- 7.1.17 It is estimated that the Development will generate and attract about 575 pcu/hr and 496 pcu/hr in the AM peak hour and generate and attract about 378 pcu/hr and 430 pcu/hr in the PM peak hour respectively with the proposed development parameters.

Operational Traffic Impact Assessment

- 7.1.18 The assessment results indicated that most of the road links are expected to operate with V/C ratios below 1 except Slip Road from Hung Tin Road (SB), Yuen Long Highway – Tin Shui Wai and Hung Tin Road which will operate at V/C ratios above 1.0 but below 1.2 in year 2034, indicating a situation of overloading and a manageable degree of congestion and Slip Road from Yuen Long Highway (WB) which will operate at V/C ratios above 1.2 indicating more serious congestion with traffic speeds deteriorating progressively with further increase in traffic. The traffic impact on these strategic roads due to the development should be timely reviewed in subsequent stages of the project in conjunction with other traffic/transport infrastructure studies conducted by the Government.
- 7.1.19 The assessment results indicate that all the critical junctions would be operated within their capacities except J8 – Castle Peak Road – Lam Tei / Fuk Hang Tsuen Road would be operated over its capacities in year 2034.
- 7.1.20 It is proposed to widen the approach arm of Fuk Hang Tsuen Road (NB) to provide one additional “turn-left” lane as shown in **Figure 5.1**. The above improvement work will be carried out by other relevant interfacing parties (i.e. by Highways Department under their proposed road widening works at Fuk Hang Tsuen Road under PWP Item No. 6852TH) subject to the implementation programme of the above works. The junction of Castle Peak Road – Lam Tei / Fuk Hang Tsuen Road (J8) could operate with adequate capacity with the proposed improvement schemes

in place. The concerned party shall be closely liaised with to ensure that the proposed improvement works shall be completed before population intake.

- 7.1.21 The assessment results reveal that the recommended local road network with the junction improvement scheme in place, would be able to accommodate the traffic demand from the Development for design year 2034.
- 7.1.22 Considering the relatively low volume of construction traffic generated by the proposed Development and the recommended route for construction traffic, no insurmountable impact on the existing road network due to the proposed Development during construction stage is anticipated.
- 7.1.23 Sensitivity study for Phases 1 & 2 intake (around 60% of the total population intake and without connection between proposed access road and Tin Shui Wai West Interchange) in 2030 has been carried out. The assessment results reveal that the recommended local road network with the junction improvement scheme in place, would be able to accommodate the traffic demand from the Development for design year 2030 under scenario for Phases 1 & 2 intake.

## **7.2 Conclusion**

- 7.2.1 In conclusion, the results of the TTIA demonstrated that with the implementation of the recommended local road network and junction improvement works, no insurmountable impact on the existing road network due to the proposed Development is anticipated.

**END OF TEXT**



## **FIGURES**

LEGEND:

 PROPOSED SITE FOR PUBLIC HOUSING DEVELOPMENT AND ASSOCIATED G/I FACILITIES

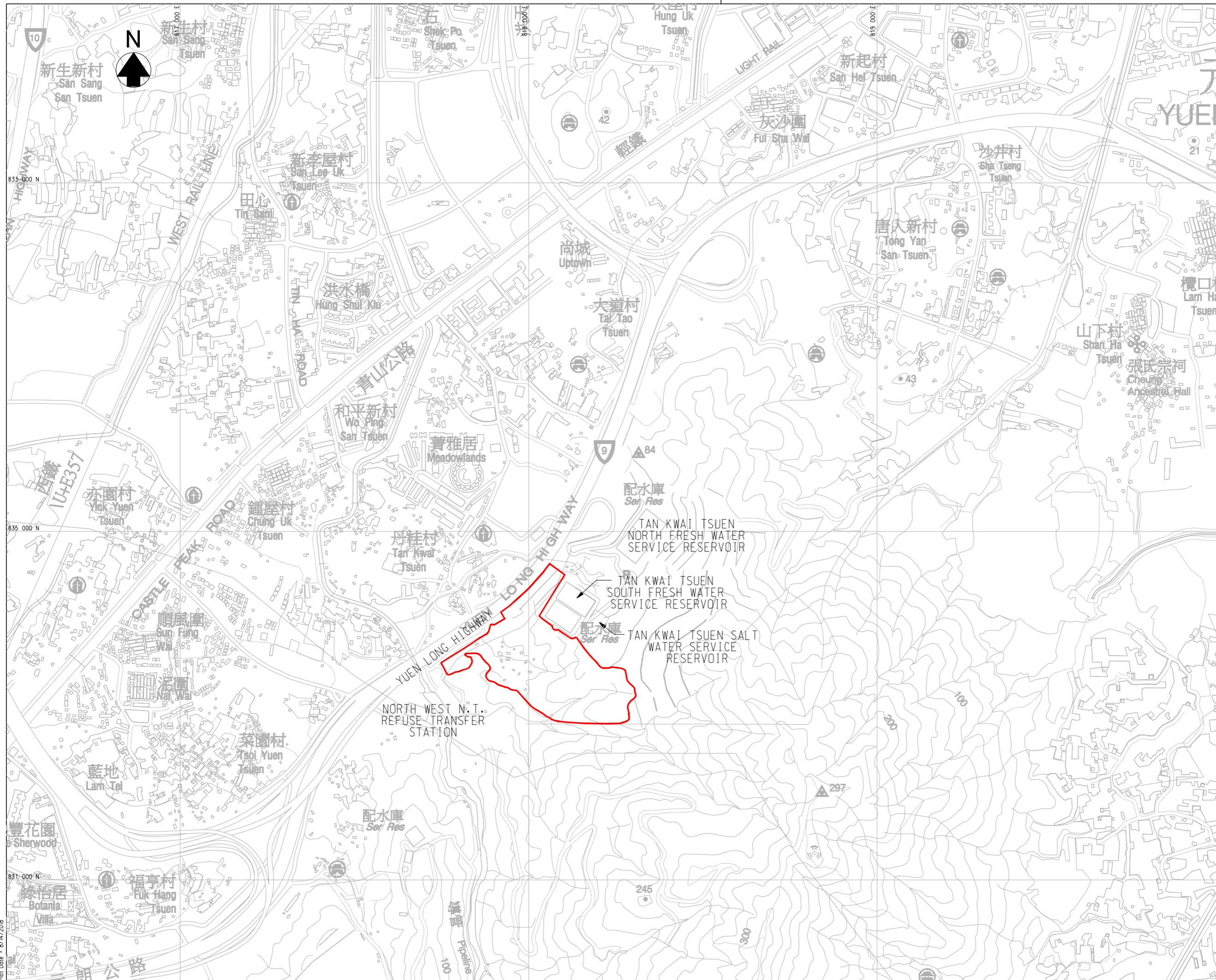

Revision	Date	Description	Initial
	Designed	Checked	Drawn
Initial	DH	LCH	SZ
Date	06/18	06/18	06/18

Approved

Agreement no. CE 92/2017 (CE)

Agreement title  
SITE FORMATION AND INFRASTRUCTURE WORKS FOR PUBLIC HOUSING DEVELOPMENT NEAR TAN KWAI TSUEN, YUEN LONG - INVESTIGATION, DESIGN AND CONSTRUCTION

Figure title  
SITE LOCATION

Figure no.	Scale
1.1	1 : 5000 (A1) 1 : 10000 (A3)

土木工程拓展署  
**CEDD** Civil Engineering and Development Department

  
BINNIES HONG KONG LIMITED  
賓尼士工程顧問有限公司

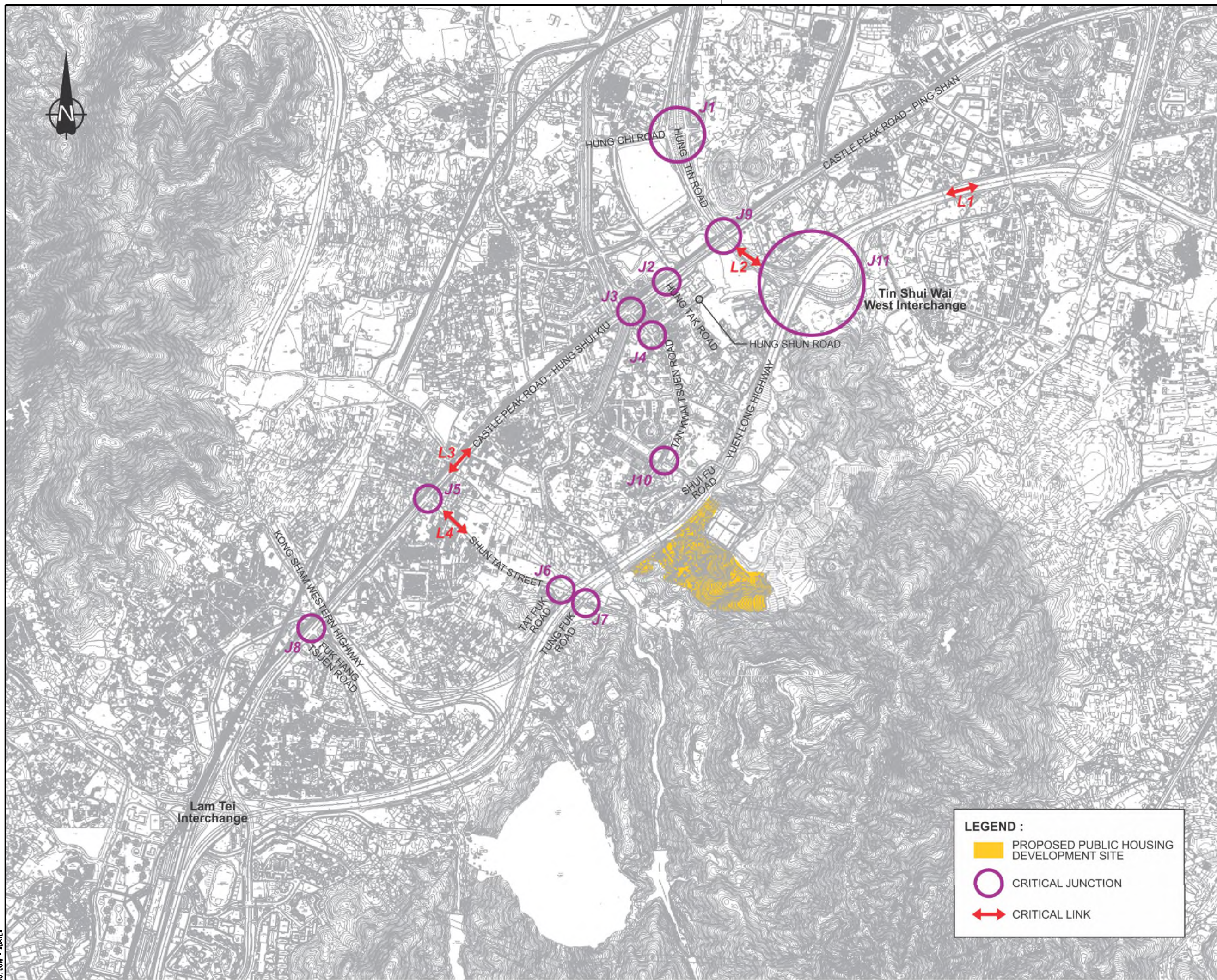

**LEGEND :**

- PROPOSED PUBLIC HOUSING DEVELOPMENT SITE
- CRITICAL JUNCTION
- CRITICAL LINK

Revision	Date	Description			Initial
		Designed	Checked	Drawn	
Initial	-	-	-	-	-
Date	-	-	-	-	-

Approved

Agreement no. CE 92/2017 (CE)

Title  
SITE FORMATION AND INFRASTRUCTURE WORKS FOR PUBLIC HOUSING DEVELOPMENT NEAR TAN KWAI TSUEN, YUEN LONG - INVESTIGATION, DESIGN AND CONSTRUCTION

Drawing Title  
EXISTING ROAD NETWORK

Drawing No.	Scale
2.1	1:10000 A3)

土木工程拓展署  
CEDD Civil Engineering and Development Department

**binnies**  
BINNIES HONG KONG LIMITED  
賓尼士工程顧問有限公司

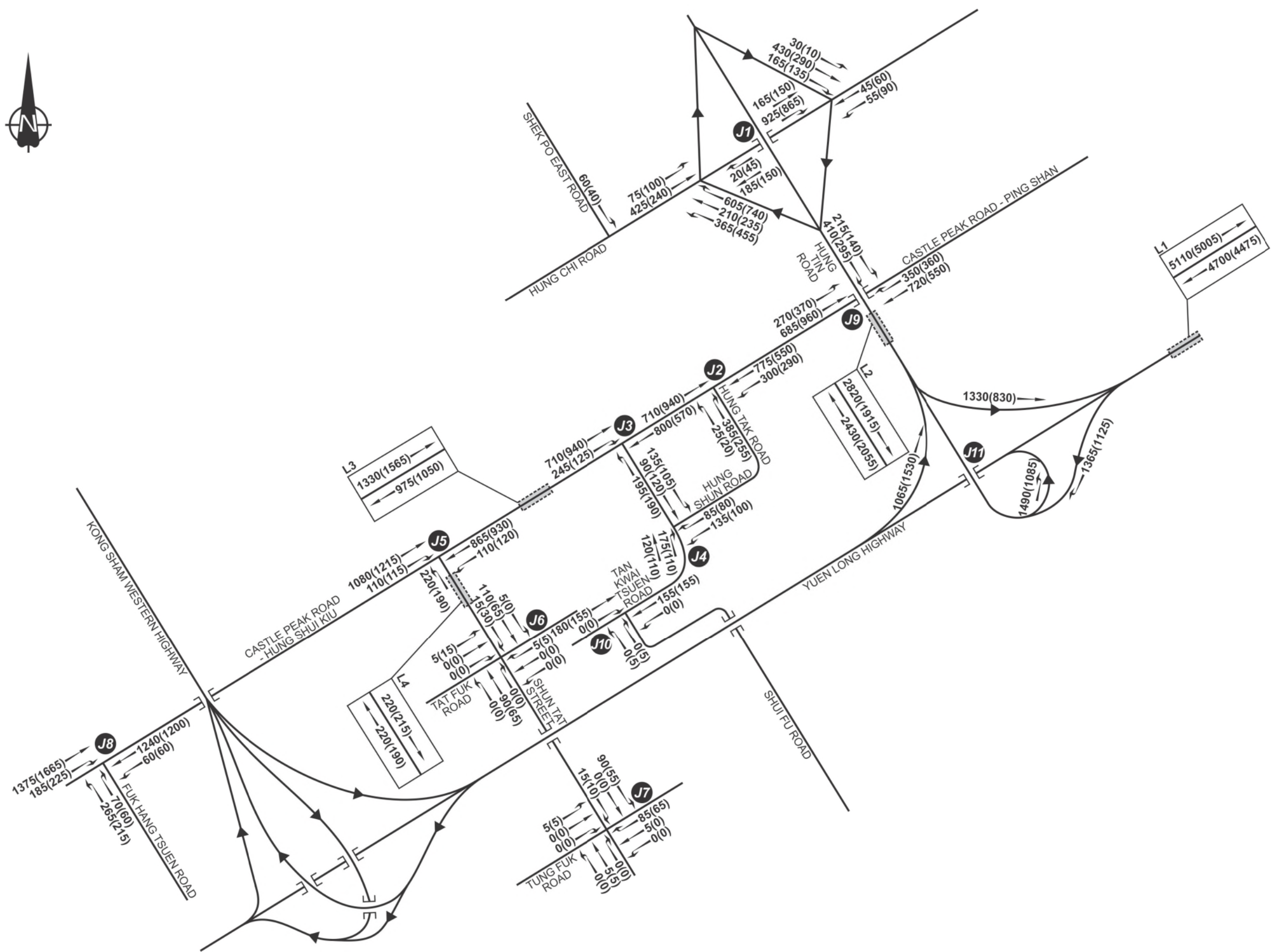

**LEGEND :**  
 1365(1125) AM(PM) PEAK HOUR TRAFFIC FLOW (PCU/HR)

Revision	Date	Description	Initial
Initial	-	-	-
Date	-	-	-

Agreement no. CE 92/2017 (CE)

Title  
 SITE FORMATION AND INFRASTRUCTURE WORKS FOR PUBLIC HOUSING DEVELOPMENT NEAR TAN KWAI TSUEN, YUEN LONG - INVESTIGATION, DESIGN AND CONSTRUCTION

Drawing Title  
 2021 OBSERVED TRAFFIC FLOWS

Drawing No.	Scale
2.2	N.T.S. (A3)

土木工程拓展署  
**CEDD** Civil Engineering and Development Department

**binnies**  
 BINNIES HONG KONG LIMITED  
 賓尼士工程顧問有限公司

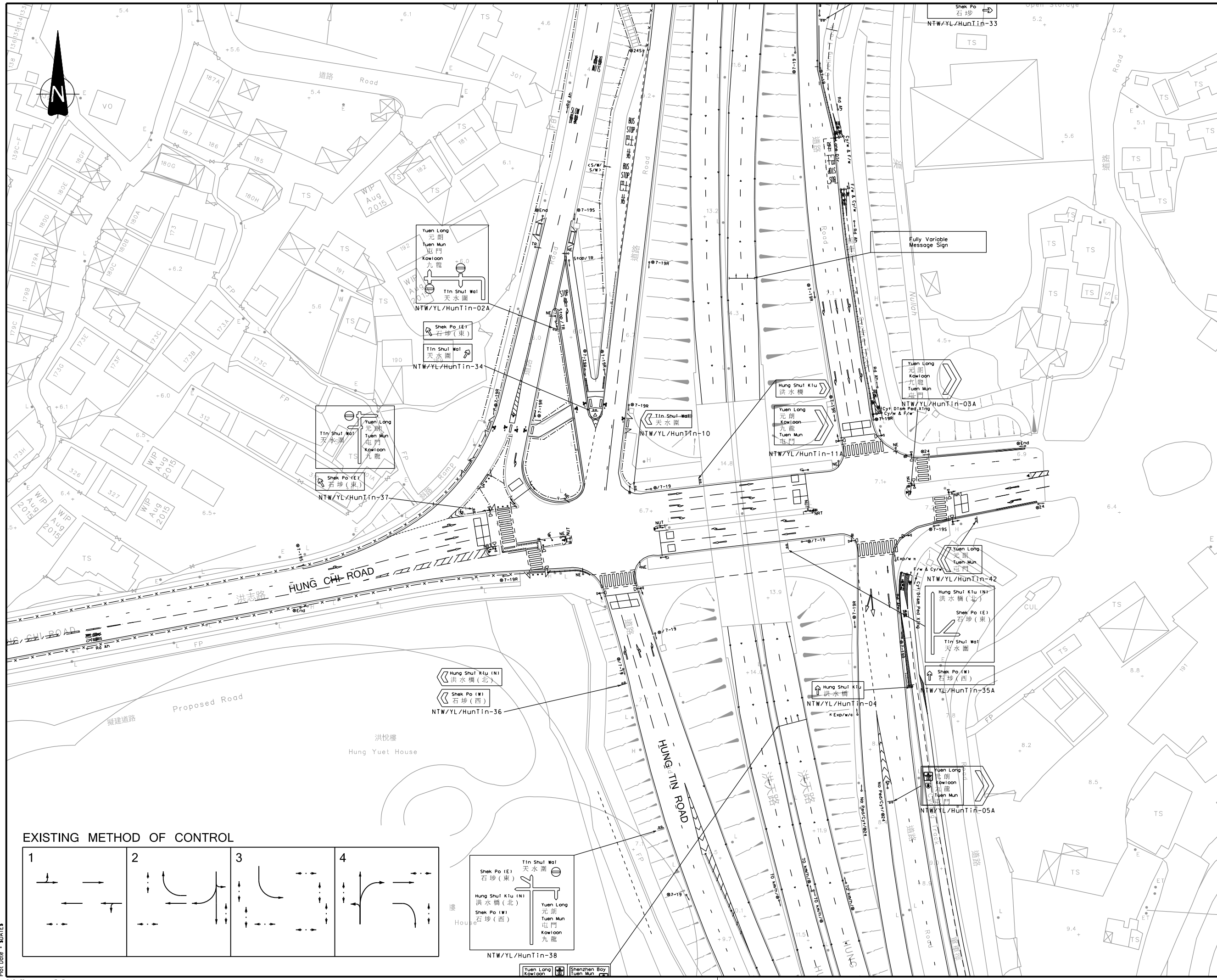

EXISTING METHOD OF CONTROL

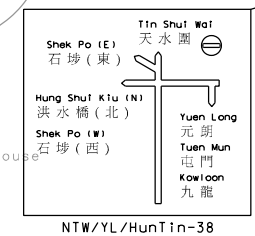
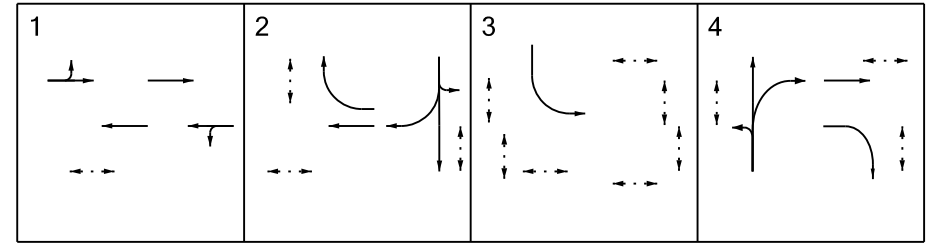

Revision	Date	Description	Initial	
Initial	Designed	Checked	Drawn	Checked
Initial	-	-	-	-
Date	-	-	-	-

Agreement No. CE 92/2017 (CE)

Agreement title  
SITE FORMATION AND INFRASTRUCTURAL WORKS FOR THE DEVELOPMENT NEAR TAN KWAI TSUEN, YUEN LONG - INVESTIGATION, DESIGN AND CONSTRUCTION

Figure title  
EXISTING JUNCTION LAYOUT OF HUNG TIN ROAD / HUNG CHI ROAD (J1)

Figure no.	Revision
2.3	-

Scale 1 : 1000 (3)

土木工程拓展署  
CEDD Civil Engineering and Development Department

binnies  
BINNIES HONG KONG LIMITED  
賓尼新工程顧問有限公司  
SYSTRA

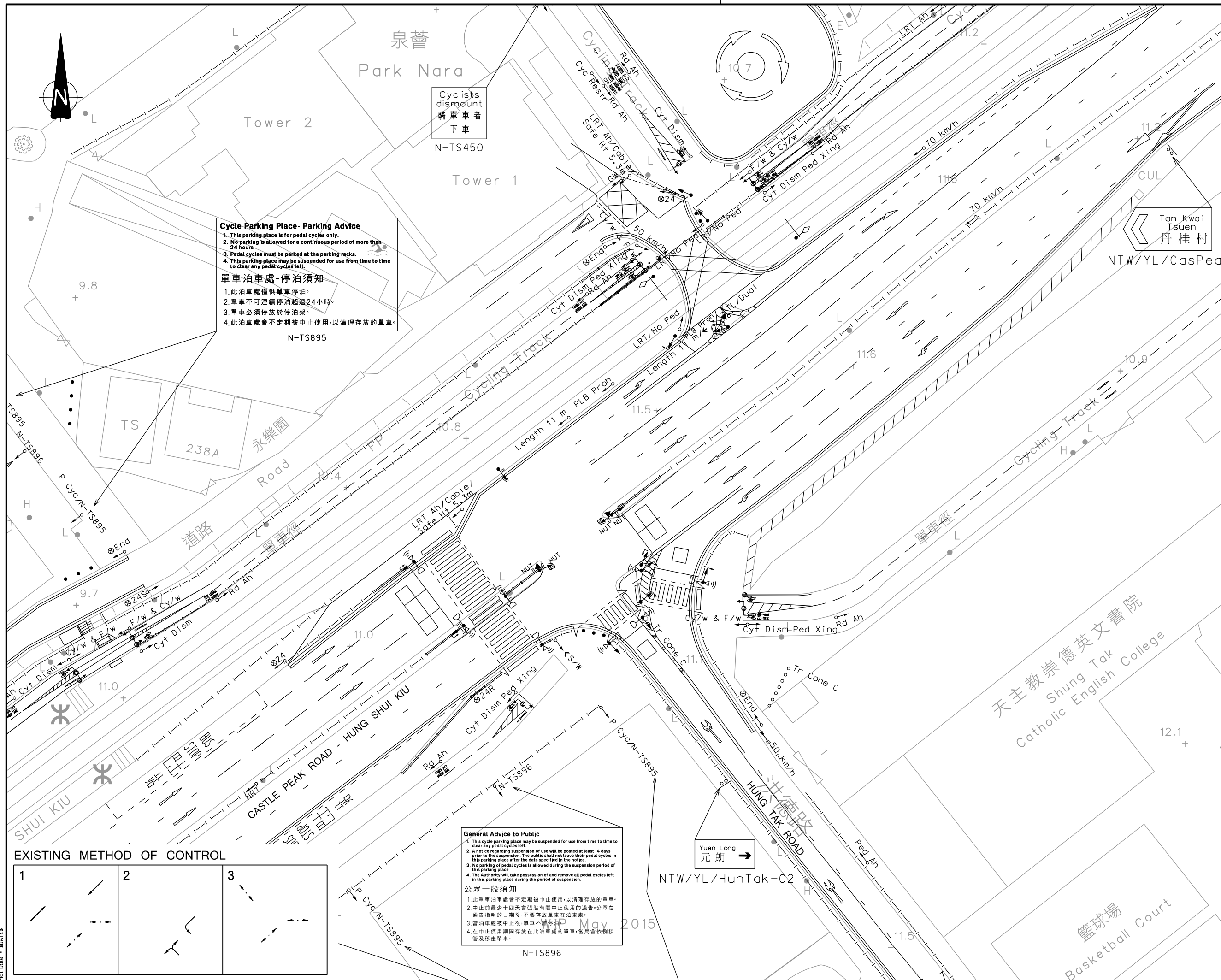

**Cycle Parking Place- Parking Advice**

1. This parking place is for pedal cycles only.
2. No parking is allowed for a continuous period of more than 24 hours.
3. Pedal cycles must be parked at the parking racks.
4. This parking place may be suspended for use from time to time to clear any pedal cycles left.

單車泊車處-停泊須知

1. 此泊車處僅供單車停泊。
2. 單車不可連續停泊超過24小時。
3. 單車必須停放於停泊架。
4. 此泊車處會不定期被中止使用，以清理存放的單車。

N-TS895

Cyclists dismount  
騎單車者下車

N-TS450

**General Advice to Public**

1. This cycle parking place may be suspended for use from time to time to clear any pedal cycles left.
2. A notice regarding suspension of use will be posted at least 14 days prior to the suspension. The public shall not leave their pedal cycles in this parking place after the date specified in the notice.
3. No parking of pedal cycles is allowed during the suspension period of this parking place.
4. The Authority will take possession of and remove all pedal cycles left in this parking place during the period of suspension.

公眾一般須知

1. 此單車泊車處會不定期被中止使用，以清理存放的單車。
2. 中止前最少十四天會張貼有關中止使用的通告，公眾在通告指明的日期後，不要存放單車在泊車處。
3. 當泊車處被中止後，單車不准停泊。
4. 在中止使用期間存放在此泊車處的單車，當局會依例接管及移走單車。

N-TS896

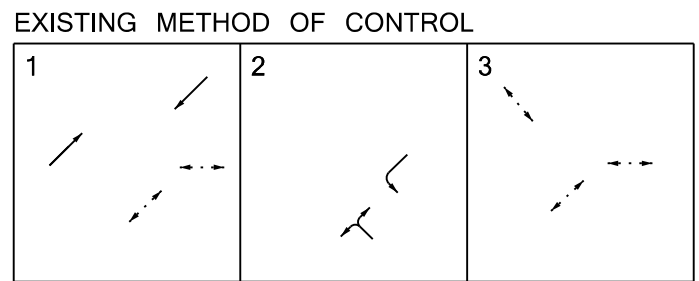

Revision	Date	Description	Initial
Initial	-	-	-
Date	-	-	-

Agreement No. CE 92/2017 (CE)

Agreement title  
SITE FORMATION AND INFRASTRUCTURAL WORKS FOR THE DEVELOPMENT NEAR TAN KWAI TSUEN, YUEN LONG - INVESTIGATION, DESIGN AND CONSTRUCTION

Figure title  
EXISTING JUNCTION LAYOUT OF CASTLE PEAK ROAD - HUNG SHUI KIU / HUNG TAK ROAD (J2)

Figure no. 2.4

Scale 1 : 500 (A3)

土木工程拓展署  
CEDD Civil Engineering and Development Department

binnies  
BINNIES HONG KONG LIMITED  
賓尼新工程顧問有限公司  
SYSTRA

Plot Date : 01/05/2015

**公眾一般須知**  
 1. 此單車泊車處會不定期被中止使用，以清理存放的單車。  
 2. 中止前最少十四天會張貼有關中止使用的通告。公眾在通告指明的日期後，不要存放單車在泊車處。  
 3. 當泊車處被中止後，單車不准停泊。  
 4. 在中止使用期間存放在此泊車處的單車，當局會依例接管及移走單車。

**Cycle Parking Place - Parking Advice**  
 1. This parking place is for pedal cycles only.  
 2. No parking is allowed for a continuous period of more than 24 hours.  
 3. Pedal cycles must be parked at the parking racks.  
 4. This parking place may be suspended for use from time to time to clear any pedal cycles left.

**單車泊車處 - 停泊須知**  
 1. 此泊車處僅供單車停泊。  
 2. 單車不可連續停泊超過24小時。  
 3. 單車必須停放於停泊架。  
 4. 此泊車處會不定期被中止使用，以清理存放的單車。

**Cycle Parking Place - Parking Advice**  
 1. This parking place is for pedal cycles only.  
 2. No parking is allowed for a continuous period of more than 24 hours.  
 3. Pedal cycles must be parked at the parking racks.  
 4. This parking place may be suspended for use from time to time to clear any pedal cycles left.

**單車泊車處 - 停泊須知**  
 1. 此泊車處僅供單車停泊。  
 2. 單車不可連續停泊超過24小時。  
 3. 單車必須停放於停泊架。  
 4. 此泊車處會不定期被中止使用，以清理存放的單車。

**Cycle Parking Place - Parking Advice**  
 1. This parking place is for pedal cycles only.  
 2. No parking is allowed for a continuous period of more than 24 hours.

**General Advice to Public**  
 1. This cycle parking place may be suspended for use from time to time to clear any pedal cycles left.  
 2. A notice regarding suspension of use will be posted at least 14 days

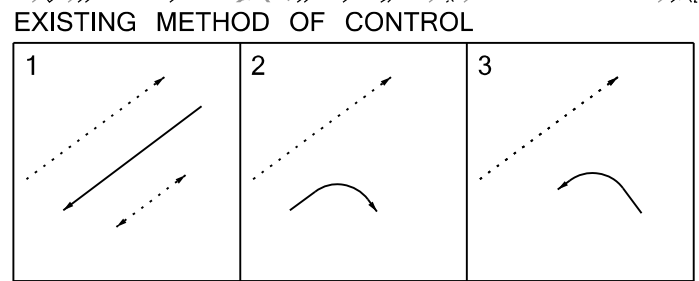

Revision	Date	Description	Initial
Initial	-	Designed	Checked
Date	-	Drawn	Checked

Agreement No. CE 92/2017 (CE)

Agreement title  
 SITE FORMATION AND INFRASTRUCTURAL WORKS FOR THE DEVELOPMENT NEAR TAN KWAI TSUEN, YUEN LONG - INVESTIGATION, DESIGN AND CONSTRUCTION

Figure title  
 EXISTING JUNCTION LAYOUT OF CASTLE PEAK ROAD - HUNG SHUI KIU / TAN KWAI TSUEN ROAD (J3)

Figure no. 2.5

Scale 1 : 500 (A3)

土木工程拓展署  
**CEDD** Civil Engineering and Development Department

**binnes**  
 BINNES HONG KONG LIMITED  
 賓尼新工程顧問有限公司  
**SYSTRA**  
 MVA

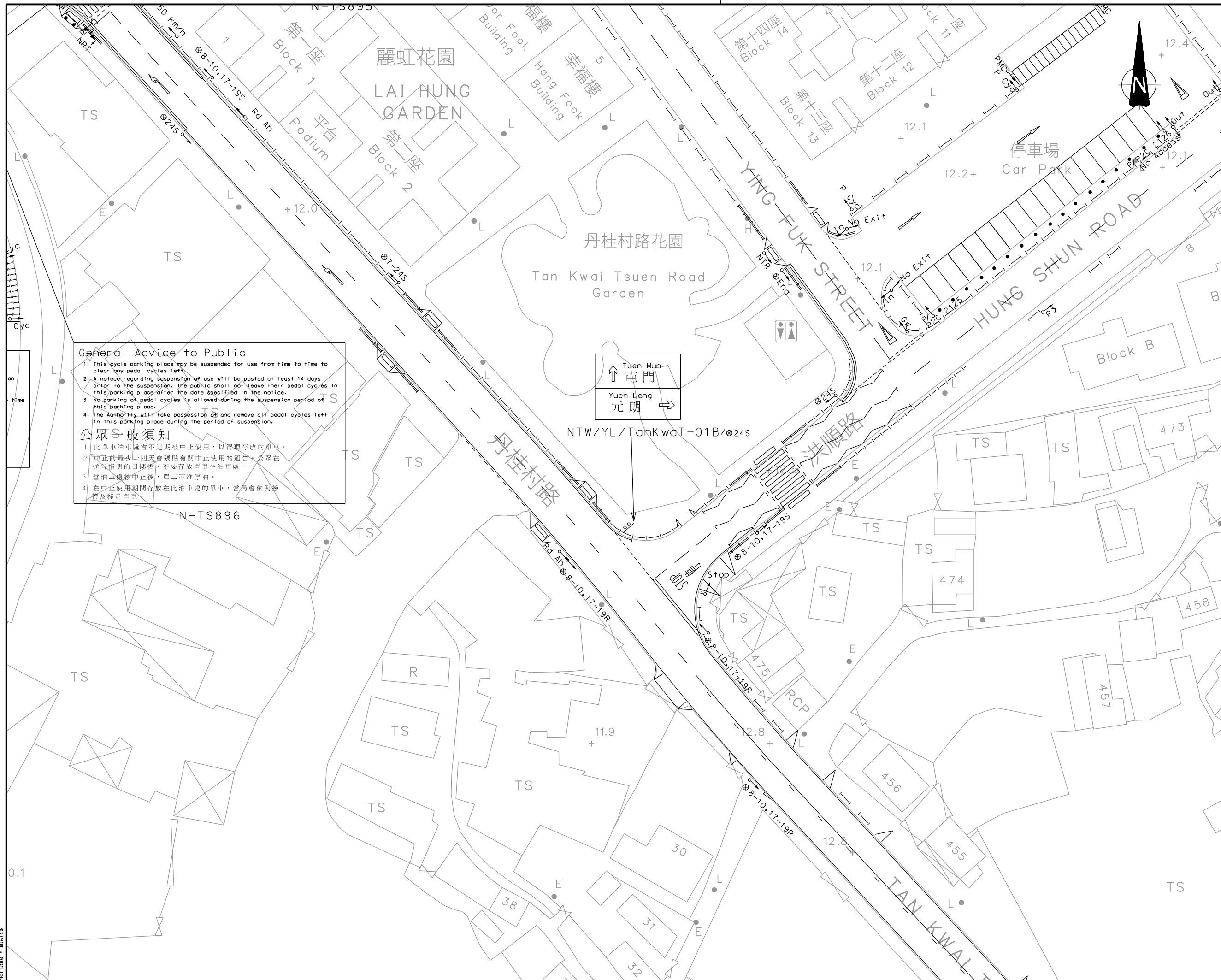

**General Advice to Public**

1. This cycle parking place may be suspended for use from time to time to clear any pedal cycles left.
2. A notice regarding suspension of use will be posted at least 14 days prior to the suspension. The public shall not leave their pedal cycles in this parking place after the date specified in the notice.
3. No parking of pedal cycles is allowed during the suspension period of this parking place.
4. The Authority will take possession of and remove all pedal cycles left in this parking place during the period of suspension.

**公眾一般須知**

1. 此單車泊車處會不定期被中止使用，以清理存放的單車。
2. 中止前最少十四天會張貼有關中止使用的通告，公眾在通告指明的日期後，不要存放單車在泊車處。
3. 當泊車處被中止後，單車不准停泊。
4. 在中止使用期間存放在此泊車處的單車，當局會依例變賣及移走單車。

Tuen Mun  
屯門  
Yuen Long  
元朗  
NTW/YL/TanKwaT-01B/245

Revision	Date	Description	Initial
Initial	-	Designed	Checked
Date	-	Drawn	Checked

Agreement No. CE 92/2017 (CE)

Agreement title  
SITE FORMATION AND INFRASTRUCTURAL WORKS FOR THE DEVELOPMENT NEAR TAN KWAI TSUEN, YUEN LONG - INVESTIGATION, DESIGN AND CONSTRUCTION

Figure title  
EXISTING JUNCTION LAYOUT OF TAN KWAI TSUEN ROAD / HUNG SHUN ROAD (J4)

Figure no. 2.6

Scale 1 : 500 (A3)

土木工程拓展署  
CEDD Civil Engineering and Development Department

binnies  
BINNIES HONG KONG LIMITED  
賓尼新工程顧問有限公司  
SYSTRA



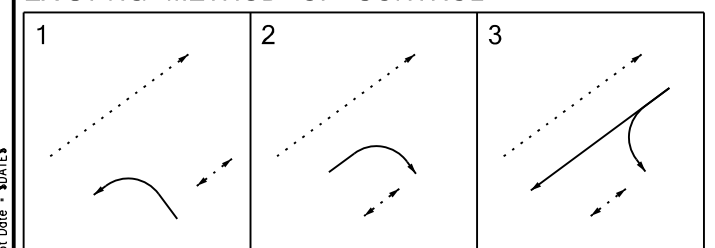
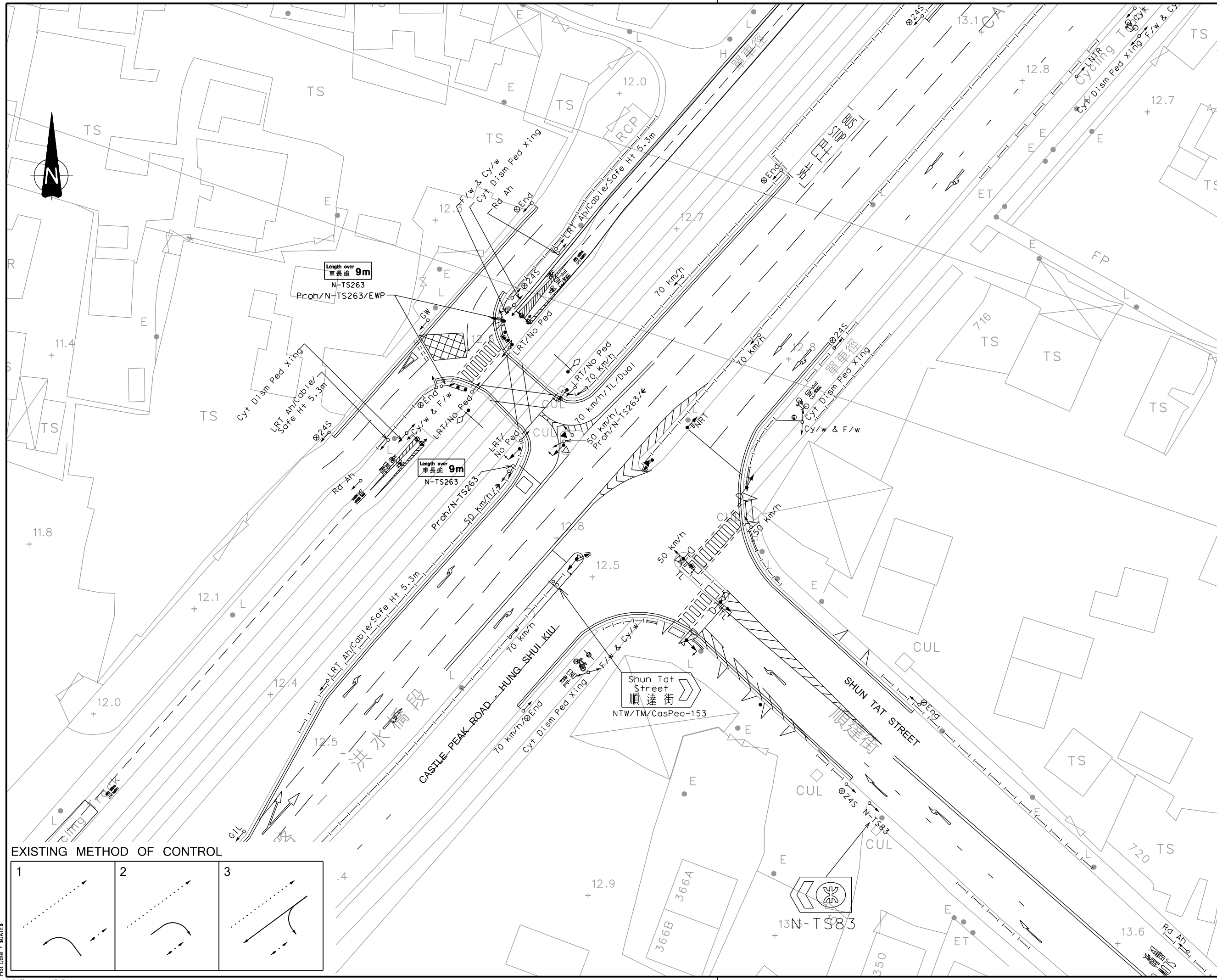

Revision	Date	Description	Initial
Initial	-	-	-
Date	-	-	-

Agreement No. CE 92/2017 (CE)

Agreement title  
 SITE FORMATION AND INFRASTRUCTURAL WORKS FOR THE DEVELOPMENT NEAR TAN KWAI TSUEN, YUEN LONG - INVESTIGATION, DESIGN AND CONSTRUCTION

Figure title  
 EXISTING JUNCTION LAYOUT OF CASTLE PEAK ROAD - HUNG SHUI KIU / SHUN TAT STREET (J5)

Figure no.	Revision
2.7	-

Scale 1 : 500 (A3)

土木工程拓展署  
**CEDD** Civil Engineering and Development Department

**binnies**  
 BINNIES HONG KONG LIMITED  
 賓尼新工程顧問有限公司  
**SYSTRA**  
 MVA

Plot Date : 20/01/22

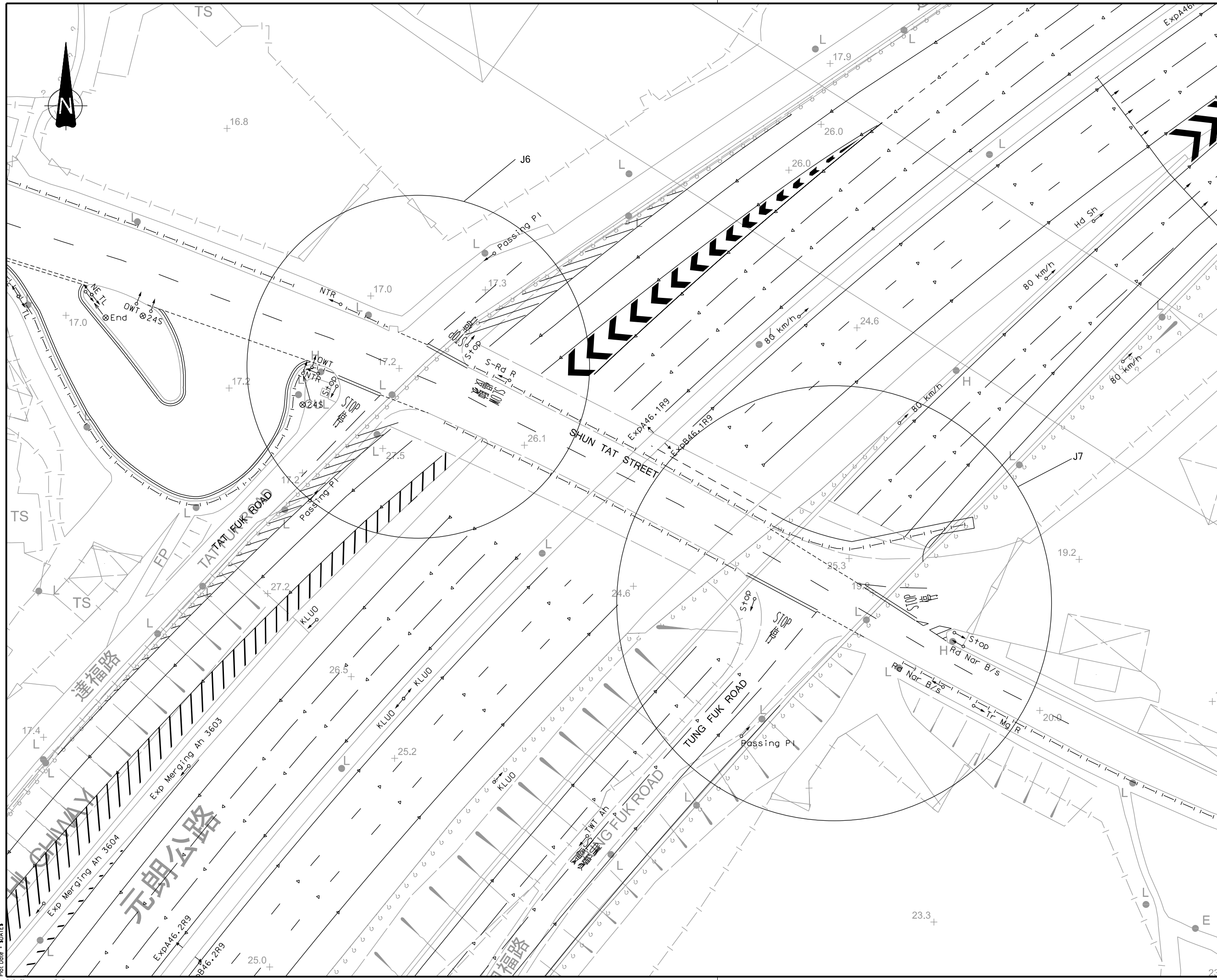

Revision	Date	Description	Initial	
	Designed	Checked	Drawn	Checked
Initial	-	-	-	-
Date	-	-	-	-

Agreement No. CE 92/2017 (CE)

Agreement title  
 SITE FORMATION AND INFRASTRUCTURAL WORKS FOR THE DEVELOPMENT NEAR TAN KWAI TSUEN, YUEN LONG - INVESTIGATION, DESIGN AND CONSTRUCTION

Figure title  
 EXISTING JUNCTION LAYOUT OF SHUN TAT STREET / TAT FUK ROAD (J6) AND SHUN TAT STREET / TUNG FUK ROAD (J7)

Figure no.	Revision
2.8	-

Scale 1 : 500 (A3)

土木工程拓展署  
**CEDD** Civil Engineering and Development Department

**binnies**  
 BINNIES HONG KONG LIMITED  
 賓尼士工程顧問有限公司  
**SYSTRA**  
 MVA

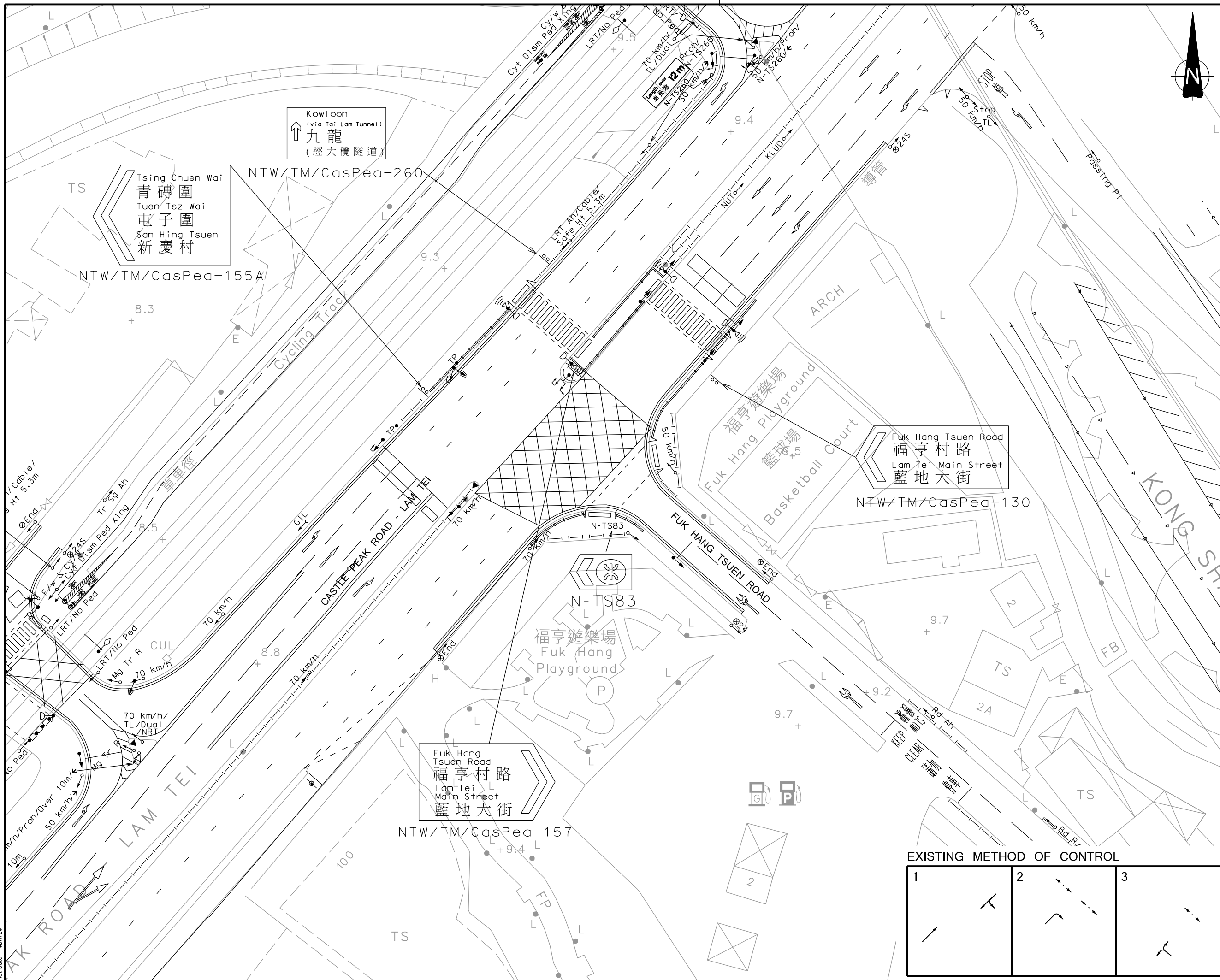
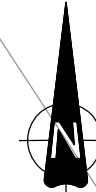

Revision	Date	Description	Initial
Initial	-	-	-
Date	-	-	-

Agreement No. CE 92/2017 (CE)

Agreement title  
SITE FORMATION AND INFRASTRUCTURAL WORKS FOR THE DEVELOPMENT NEAR TAN KWAI TSUEN, YUEN LONG - INVESTIGATION, DESIGN AND CONSTRUCTION

Figure title  
EXISTING JUNCTION LAYOUT OF CASTLE PEAK ROAD - LAM TEI / FUK HANG TSUEN ROAD (J8)

Figure no.	Revision
2.9	-

Scale 1 : 500 (A3)

土木工程拓展署  
CEDD Civil Engineering and Development Department

BINNIES HONG KONG LIMITED  
賓尼新工程顧問有限公司

EXISTING METHOD OF CONTROL

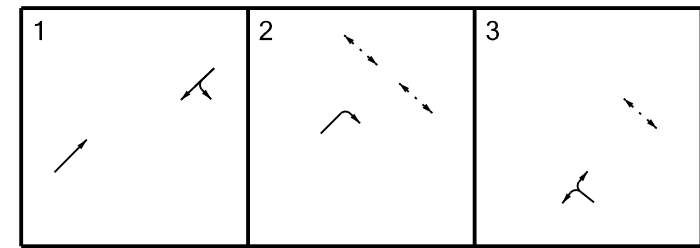

Plot Date : 20/01/22





Revision	Date	Description	Initial
		Designed	Checked
		Drawn	Checked
Initial	-	-	-
Date	-	-	-

Agreement No. CE 92/2017 (CE)

Agreement title  
 SITE FORMATION AND INFRASTRUCTURAL WORKS FOR THE DEVELOPMENT NEAR TAN KWAI TSUEN, YUEN LONG - INVESTIGATION, DESIGN AND CONSTRUCTION

Figure title  
 EXISTING JUNCTION LAYOUT OF TAN KWAI TSUEN ROAD / SHUI FU ROAD (J10)

Figure no. 2.11

Scale 1 : 500 (A3)

土木工程拓展署  
**CEDD** Civil Engineering and Development Department

**binnies**  
 BINNIES HONG KONG LIMITED  
 賓尼新工程顧問有限公司  
**SYSTRA**  
 MVA

LEGEND:

- POTENTIAL PUBLIC HOUSING SITE
- PROPOSED SLOPE
- 66.12 EXISTING LEVEL
- +65 PROPOSED LEVEL
- PROPOSED RETAINING WALL
- EXISTING WSD NO BLASTING LIMIT / WWR
- PROPOSED PUBLIC ROAD
- POTENTIAL INTERNAL ROAD
- FOOTPATH EFFECTIVE WIDTH OF 2.75m
- FOOTPATH EFFECTIVE WIDTH OF 1.5m
- FOOTPATH INDEX

Revision	Date	Description	Initial
Initial	SFL	LCH	SZ
Date	01/22	01/22	01/22

Approved

Agreement no. CE 92/2017 (CE)

Title  
**SITE FORMATION AND INFRASTRUCTURE WORKS FOR PUBLIC HOUSING DEVELOPMENT NEAR TAN KWAI TSUEN, YUEN LONG - INVESTIGATION, DESIGN AND CONSTRUCTION**

Drawing Title  
**PROPOSED LOCAL ROAD NETWORK**

Drawing No.	Scale
3.1	1:3000(A1) 1:6000(A3)

**Civil Engineering and Development Department**

**BINNIES HONG KONG LIMITED**  
 賓尼士工程顧問有限公司

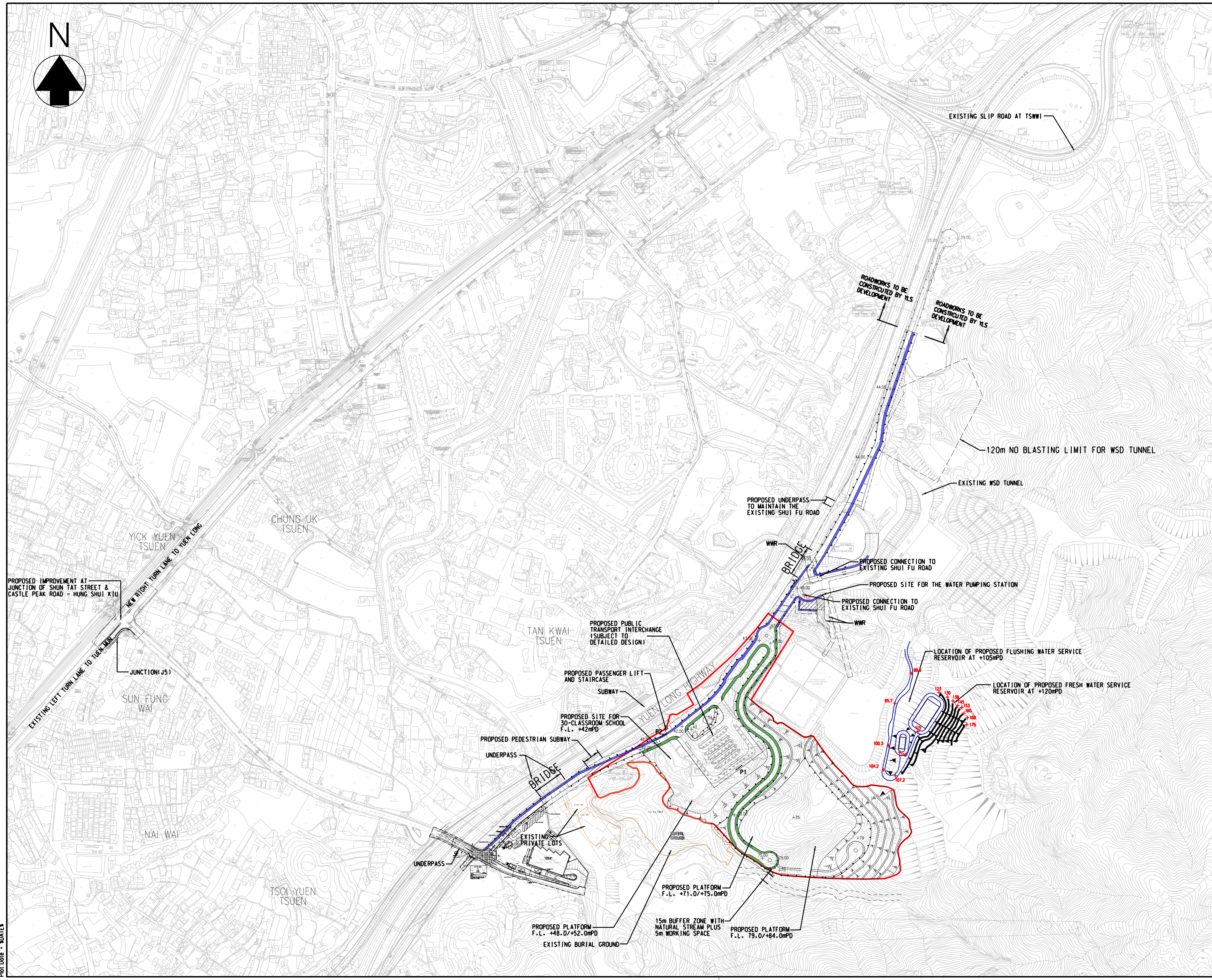

LEGEND:  
 PROPOSED TRAFFIC LIGHT

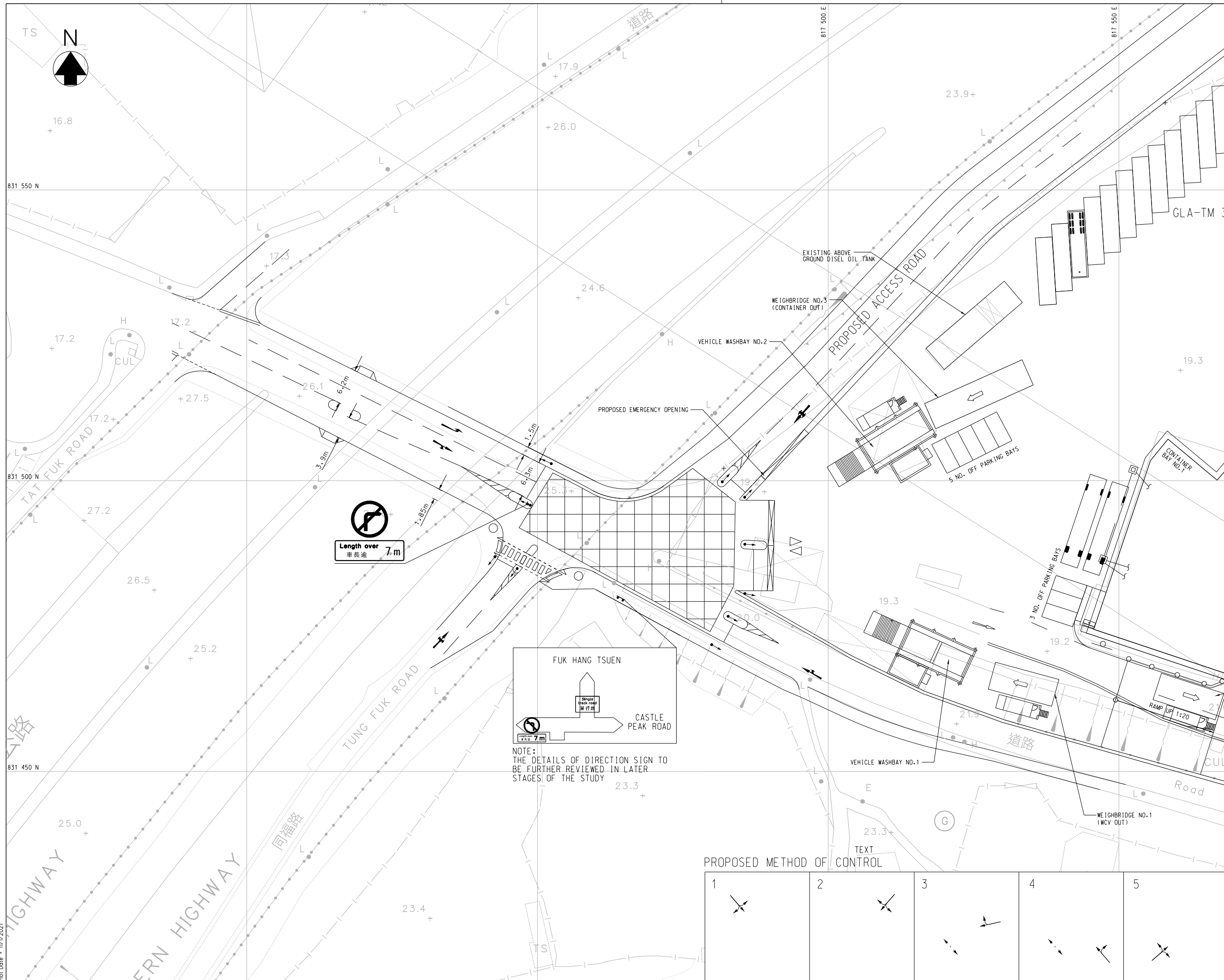

Length over 7m  
 車長逾 7m

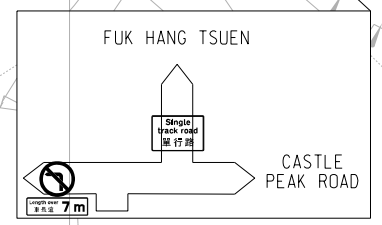

NOTE:  
 THE DETAILS OF DIRECTION SIGN TO BE FURTHER REVIEWED IN LATER STAGES OF THE STUDY

PROPOSED METHOD OF CONTROL

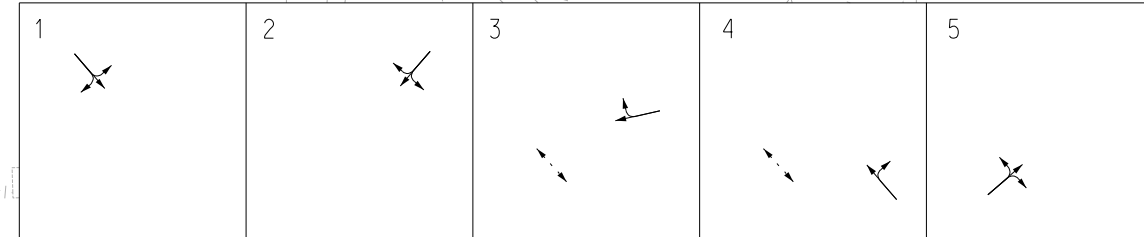

Revision	Date	Description			Initial
		Designed	Checked	Drawn	
Initial	FN	LCH	SZ	LCH	
Date	08/19	08/19	08/19	08/19	08/19

Agreement no.  
 CE 92/2017 (CE)

Title  
 SITE FORMATION AND INFRASTRUCTURE WORKS FOR PUBLIC HOUSING DEVELOPMENT NEAR TAN KWAI TSUEN, YUEN LONG - INVESTIGATION, DESIGN AND CONSTRUCTION

Drawing Title  
 Proposed Junction Layout of Shun Tat Street / Proposed Access Road / Tung Fuk Road (J7)

Drawing No. 3.2  
 Scale 1 : 300 (A1) / 1 : 600 (A3)

**CEDD** Civil Engineering and Development Department

**binies**  
 BINNIES HONG KONG LIMITED  
 賓尼士工程顧問有限公司

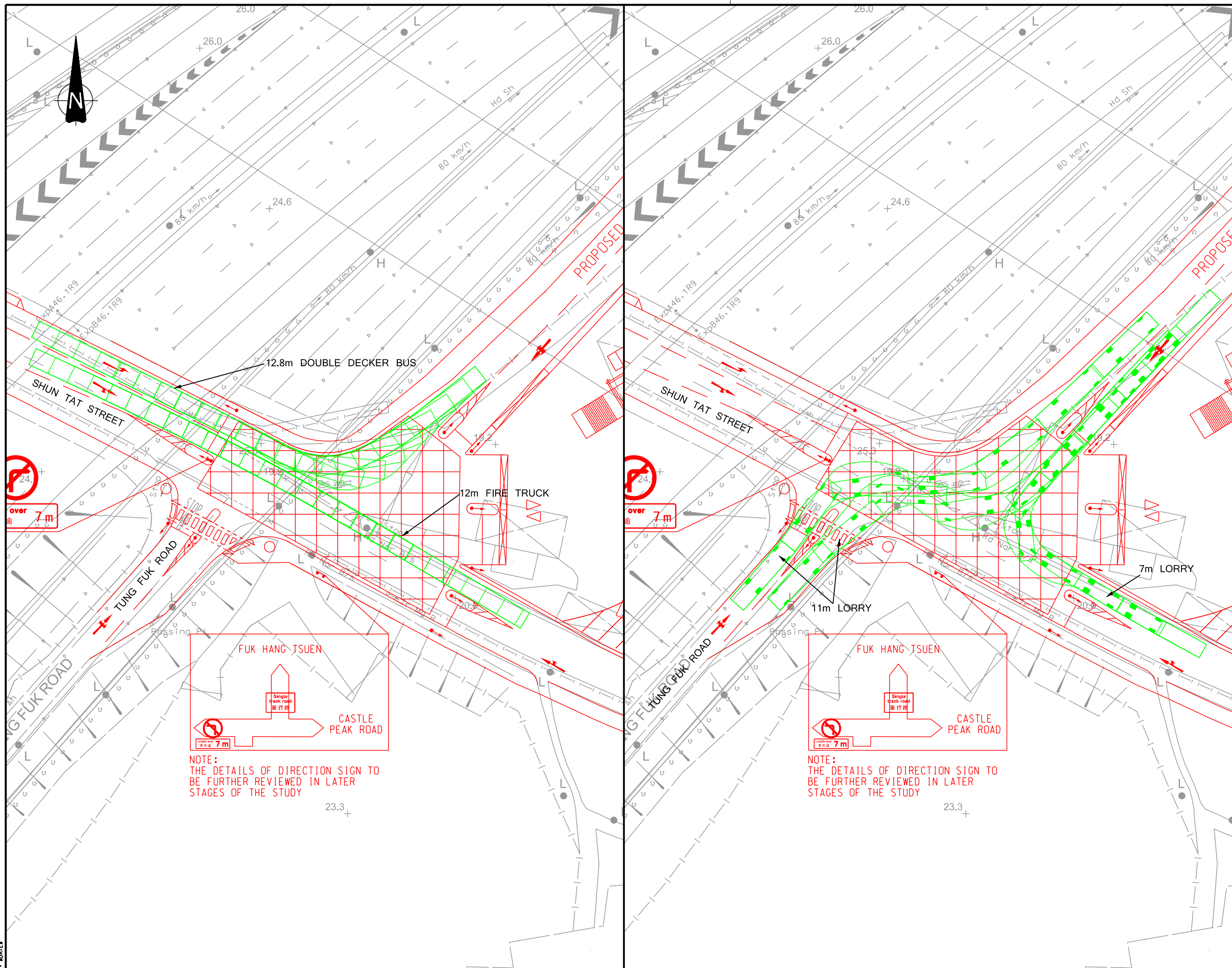

Revision	Date	Description	Initial
A	14SEP22	JUNCTION LAYOUT REVISED	T&M
	Designed	Checked	Drawn
			Checked
Initial	-	-	-
Date	-	-	-

Agreement no. CE 92/2017 (CE)

**TITLE**  
 SITE FORMATION AND INFRASTRUCTURE WORKS FOR PUBLIC HOUSING DEVELOPMENT NEAR TAN KWAI TSUEN, YUEN LONG - INVESTIGATION, DESIGN AND CONSTRUCTION

**Drawing Title**  
 SWEEP PATH ANALYSIS AT JUNCTION OF SHUN TAT STREET / PROPOSED ACCESS ROAD / TUNG FUK ROAD (J7)

Drawing No.	Scale
3.3	1 : 500 (A3)

土木工程拓展署  
**CEDD** Civil Engineering and Development Department

**binnes**  
 BINNIES HONG KONG LIMITED  
 賓尼士工程顧問有限公司

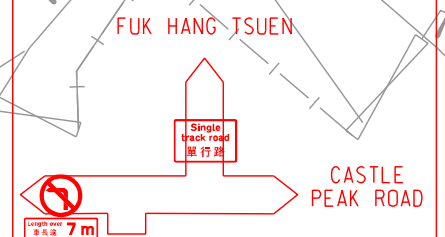

NOTE:  
 THE DETAILS OF DIRECTION SIGN TO BE FURTHER REVIEWED IN LATER STAGES OF THE STUDY

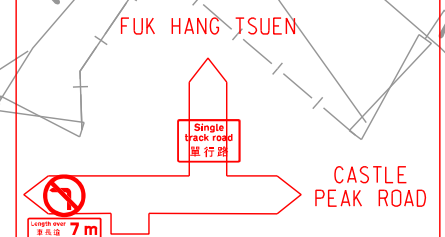

NOTE:  
 THE DETAILS OF DIRECTION SIGN TO BE FURTHER REVIEWED IN LATER STAGES OF THE STUDY

SWEEP PATH ANALYSIS OF 12.8m DOUBLE DECKER BUS AND 12m FIRE TRUCK

SWEEP PATH ANALYSIS OF 11m AND 7m LORRY



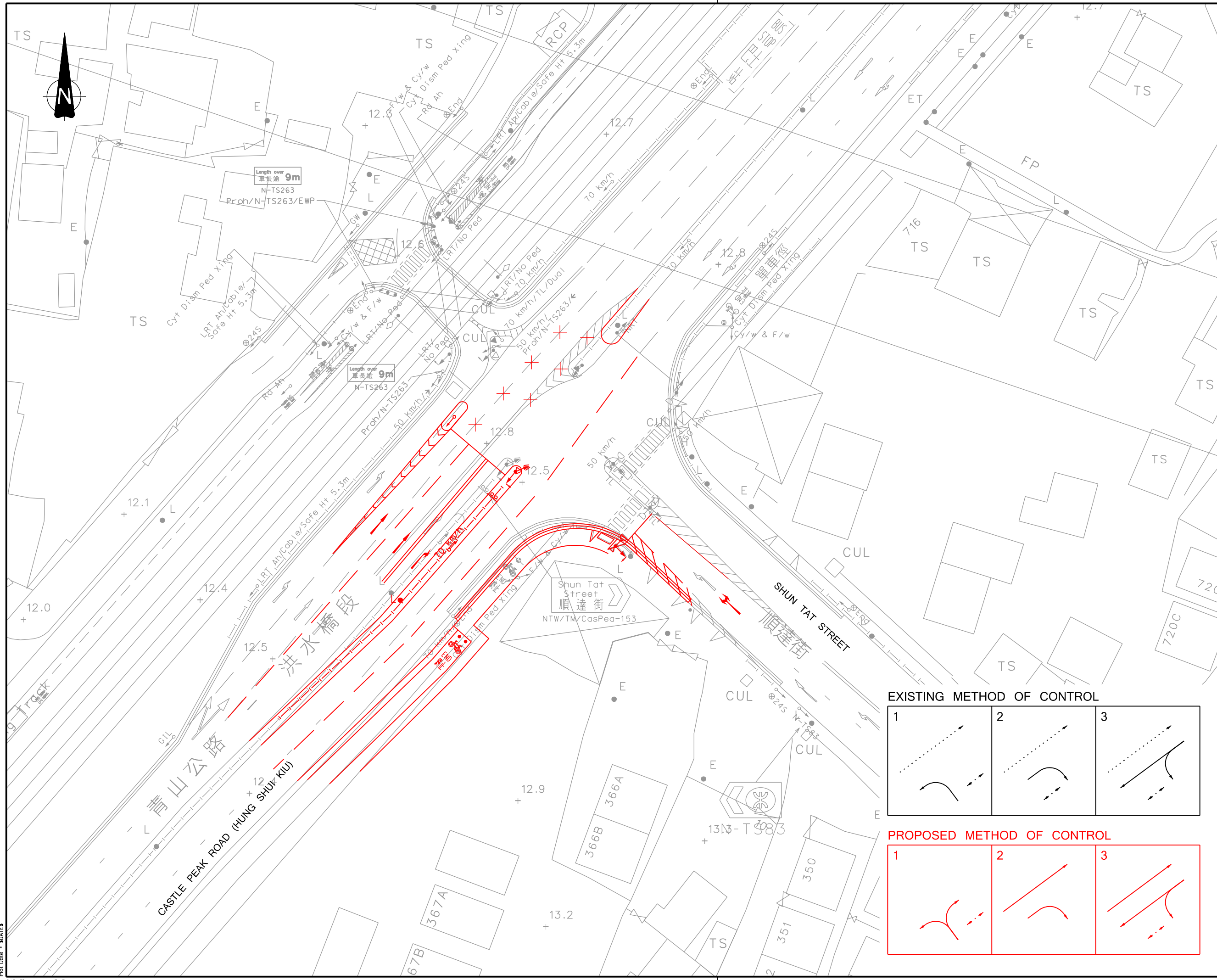

Revision	Date	Description	Initial
Initial	-	-	-
Date	-	-	-

Agreement No. CE 92/2017 (CE)

Agreement title  
 SITE FORMATION AND INFRASTRUCTURAL WORKS FOR THE DEVELOPMENT NEAR TAN KWAI TSUEN, YUEN LONG - INVESTIGATION, DESIGN AND CONSTRUCTION

Figure title  
 PROPOSED IMPROVEMENT SCHEME AT JUNCTION OF CASTLE PEAK ROAD - HUNG SHUI KIU / SHUN TAT STREET (J5)

Figure no.	Revision
3.4	-

Scale 1 : 500 (A3)

土木工程拓展署  
**CEDD** Civil Engineering and Development Department

**binnies**  
 BINNIES HONG KONG LIMITED  
 賓尼士工程顧問有限公司  
**SYSTRA**  
 MVA

EXISTING METHOD OF CONTROL

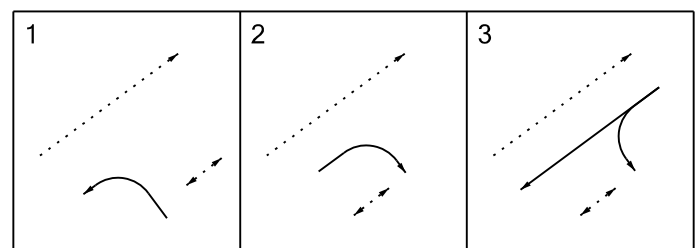

PROPOSED METHOD OF CONTROL

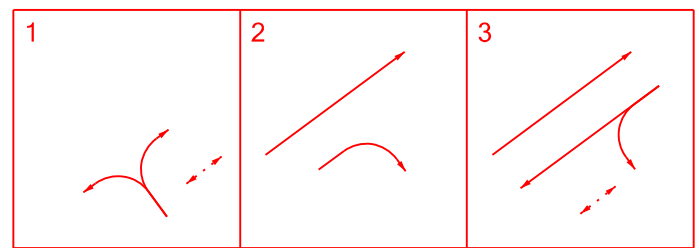

PROPOSED METHOD OF CONTROL

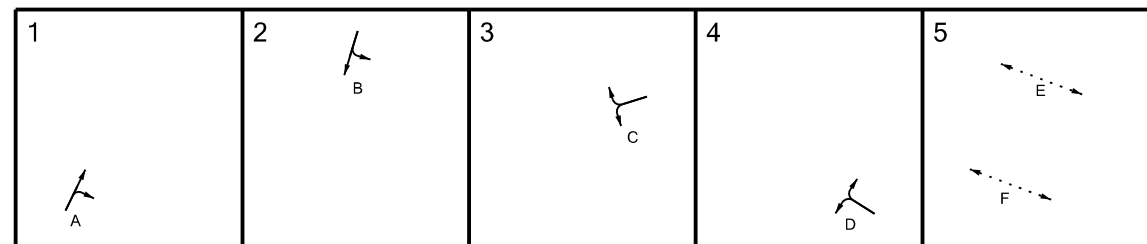

Fu Tei, University  
 Lam Tei, Shenzhen Bay  
 虎地、大學  
 藍地、深圳灣

12km  
 16  
 NTW/YL/YueLonH-XG51A

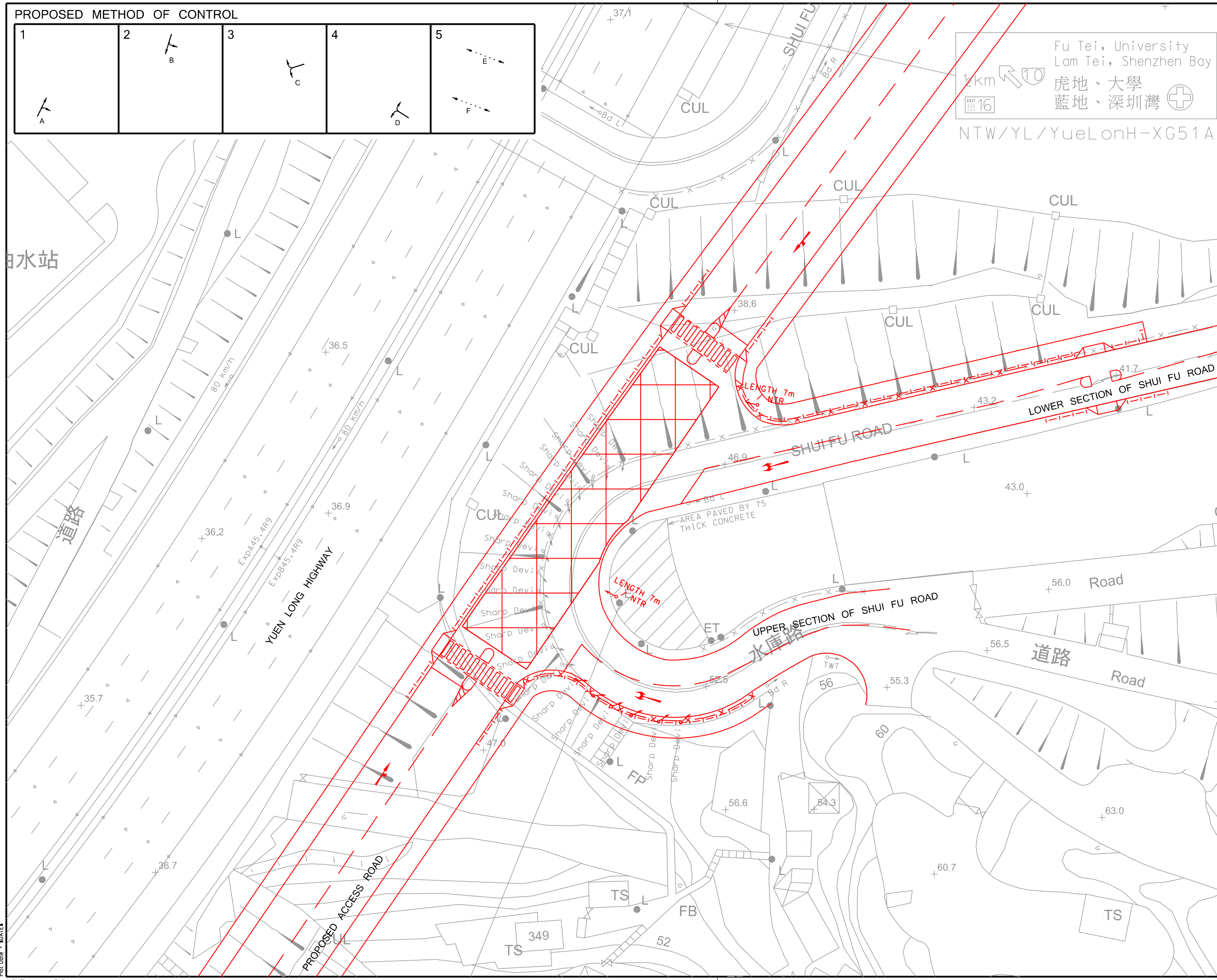

© Copyright by Black & Veatch Hong Kong Limited

Revision	Date	Description	Initial
		Designed	Checked
		Drawn	Checked

Agreement No. CE 92/2017 (CE)

Agreement title  
 SITE FORMATION AND INFRASTRUCTURAL WORKS FOR THE DEVELOPMENT NEAR TAN KWAI TSUEN, YUEN LONG - INVESTIGATION, DESIGN AND CONSTRUCTION

Figure title  
 PROPOSED JUNCTION LAYOUT OF SHUI FU ROAD AND PROPOSED ACCESS ROAD (J12)

Figure no.	3.5	Revision	-
------------	-----	----------	---

Scale 1 : 500 (A3)

土木工程拓展署  
**CEDD** Civil Engineering and Development Department

BINNIES HONG KONG LIMITED  
 賓尼新工程顧問有限公司  
 SYSTRA

Plot Date : 20/01/22



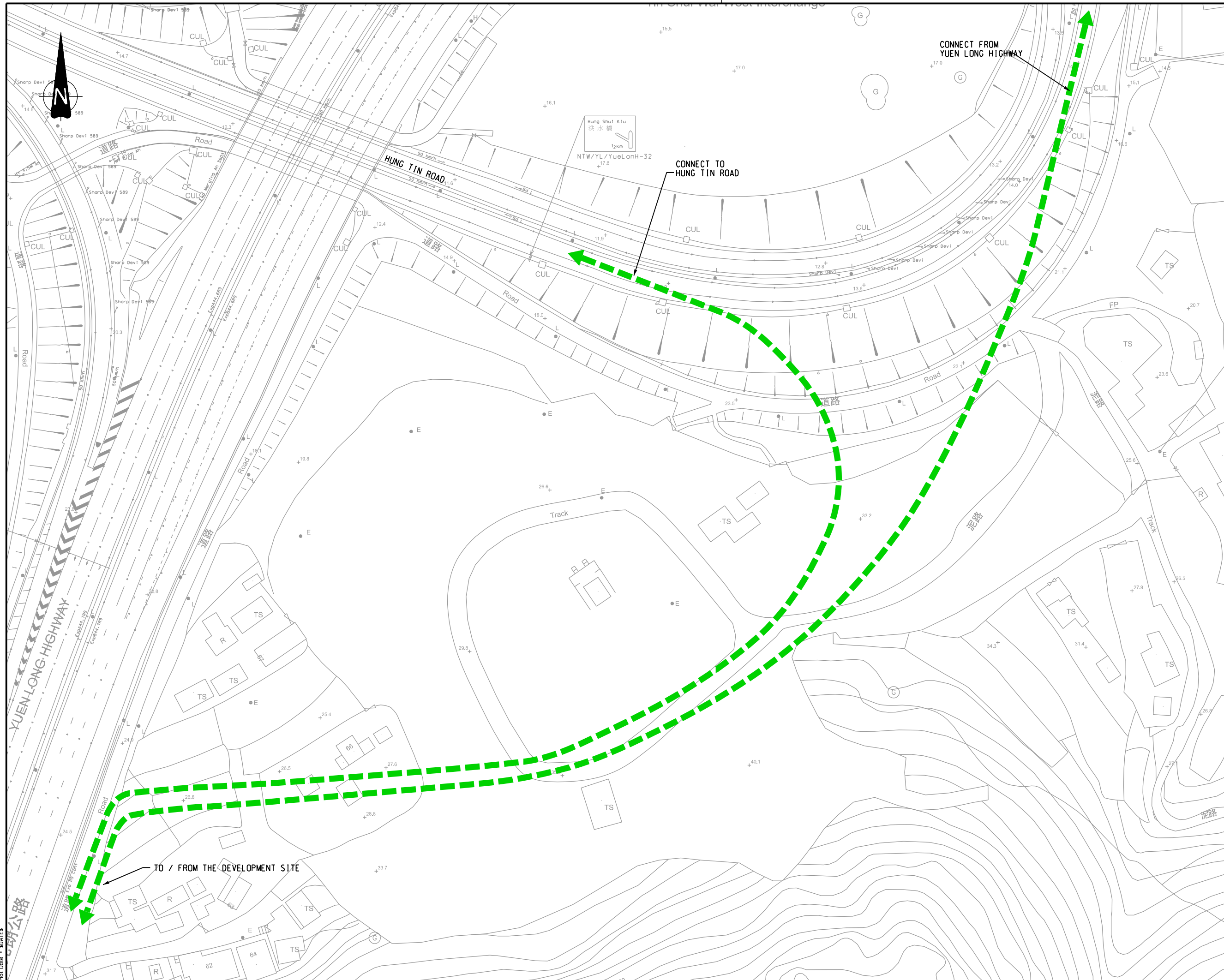

Revision	Date	Description	Initial
		Designed	Checked
		Drawn	Checked

Agreement No. CE 92/2017 (CE)

Agreement title  
 SITE FORMATION AND INFRASTRUCTURAL WORKS FOR THE DEVELOPMENT NEAR TAN KWAI TSUEN, YUEN LONG - INVESTIGATION, DESIGN AND CONSTRUCTION

Figure title  
 PROPOSED CONNECTION TO TSWWI

Figure no. 3.7

Scale 1 : 1000 (A3)

土木工程拓展署  
**CEDD** Civil Engineering and Development Department

**binnes**  
 BINNIES HONG KONG LIMITED  
 賓尼士工程顧問有限公司  
**SYSTRA**  
 MVA

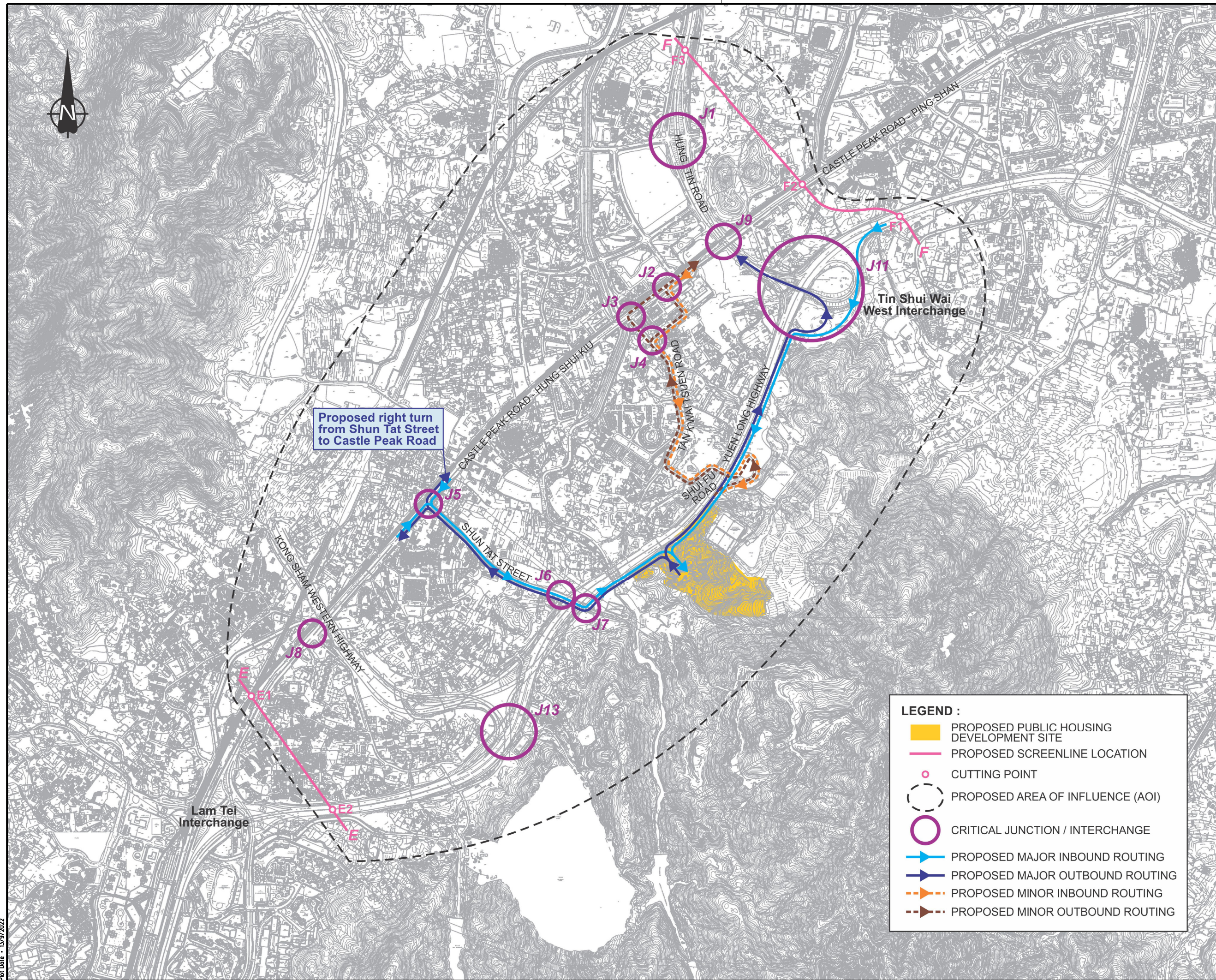

Proposed right turn from Shun Tat Street to Castle Peak Road

**LEGEND :**

- PROPOSED PUBLIC HOUSING DEVELOPMENT SITE
- PROPOSED SCREENLINE LOCATION
- CUTTING POINT
- PROPOSED AREA OF INFLUENCE (AOI)
- CRITICAL JUNCTION / INTERCHANGE
- PROPOSED MAJOR INBOUND ROUTING
- PROPOSED MAJOR OUTBOUND ROUTING
- PROPOSED MINOR INBOUND ROUTING
- PROPOSED MINOR OUTBOUND ROUTING

Revision	Date	Description	Initial
A	13SEP22	TD COMMENTS INCORPORATED	T&M
		Designed	Checked
		Drawn	Checked
Initial	-	-	-
Date	-	-	-

Agreement no. CE 92/2017 (CE)

**TITLE**  
 SITE FORMATION AND INFRASTRUCTURE WORKS FOR PUBLIC HOUSING DEVELOPMENT NEAR TAN KWAI TSUEN, YUEN LONG - INVESTIGATION, DESIGN AND CONSTRUCTION

**Drawing Title**  
 PROPOSED SCREENLINES AND JUNCTIONS FOR VALIDATION

Drawing No.	Scale
4.1	N.T.S.

土木工程拓展署  
**CEDD** Civil Engineering and Development Department

**binnies**  
 BINNIES HONG KONG LIMITED  
 賓尼士工程顧問有限公司

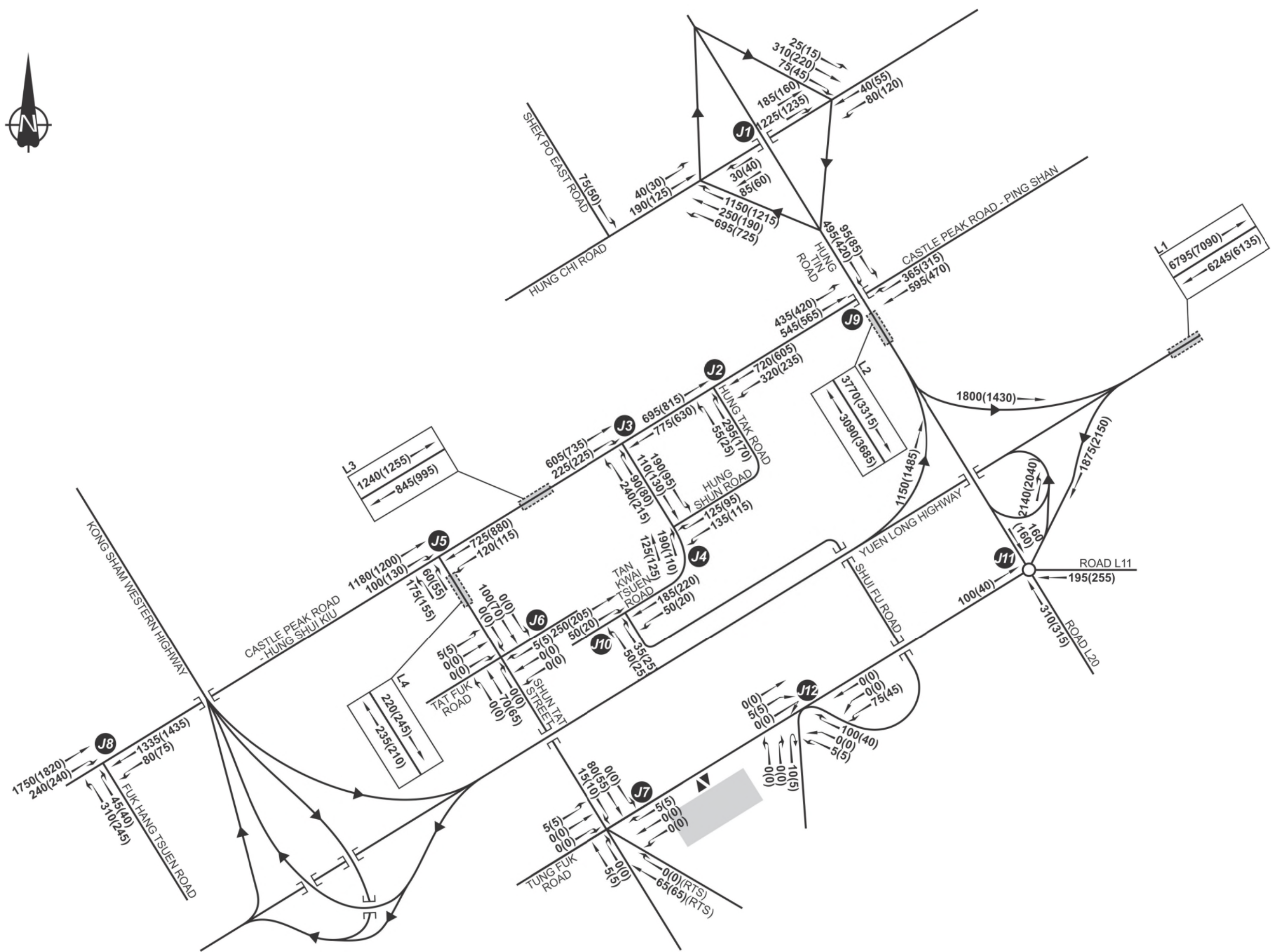

**LEGEND :**  
 [Grey Box] SUBJECT SITE  
 1875(2150) AM(PM) PEAK HOUR TRAFFIC FLOW (PCU/HR)

Revision	Date	Description	Initial
A	27MAY22	ROAD NETWORK UPDATED	TkW
	Designed	Checked	Drawn
	Initial	-	-
	Date	-	-

Agreement no. CE 92/2017 (CE)

Title  
 SITE FORMATION AND INFRASTRUCTURE WORKS FOR PUBLIC HOUSING DEVELOPMENT NEAR TAN KWAI TSUEN, YUEN LONG - INVESTIGATION, DESIGN AND CONSTRUCTION

Drawing Title  
 2034 REFERENCE TRAFFIC FLOWS

Drawing No.	Scale
4.2	N.T.S. (A3)

土木工程拓展署  
 CEDD Civil Engineering and Development Department

binnies  
 BINNIES HONG KONG LIMITED  
 賓尼士工程顧問有限公司

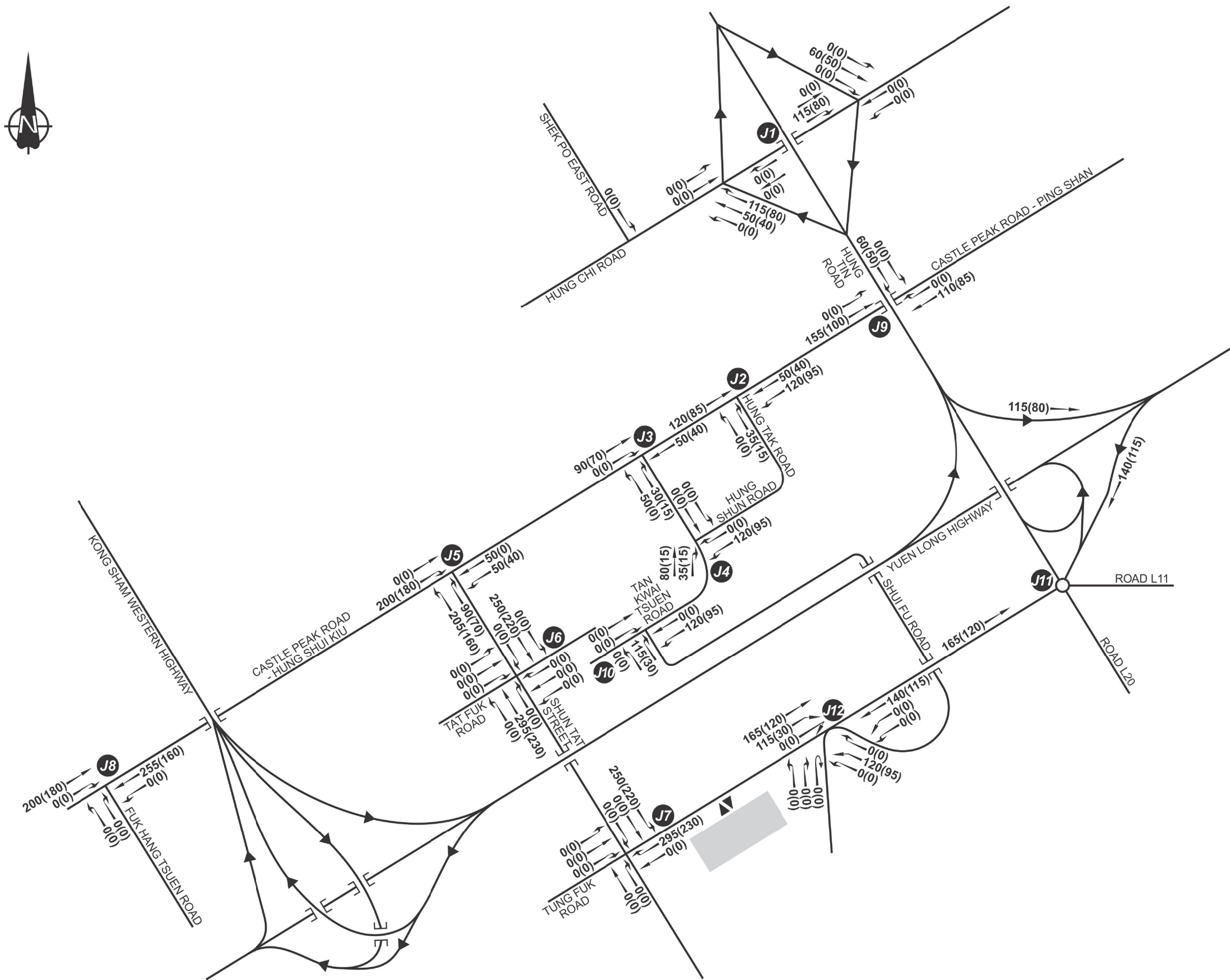

**LEGEND :**  
 [Grey Box] SUBJECT SITE  
 140(115) AM(PM) PEAK HOUR TRAFFIC FLOW (PCU/HR)

B	13SEP22	TD COMMENTS INCORPORATED	TKM	
A	27MAY22	ROAD NETWORK UPDATED	TKM	
Revision	Date	Description	Initial	
	Designed	Checked	Drawn	Checked
Initial	-	-	-	-
Date	-	-	-	-

Agreement no. CE 92/2017 (CE)

**TITLE**  
 SITE FORMATION AND INFRASTRUCTURE WORKS FOR PUBLIC HOUSING DEVELOPMENT NEAR TAN KWAI TSUEN, YUEN LONG - INVESTIGATION, DESIGN AND CONSTRUCTION

**Drawing Title**  
 2034 DEVELOPMENT TRAFFIC FLOWS

Drawing No.	Scale
4.3	N.T.S. (A3)

土木工程拓展署  
**CEDD** Civil Engineering and Development Department

**binnies**  
 BINNIES HONG KONG LIMITED  
 賓尼士工程顧問有限公司

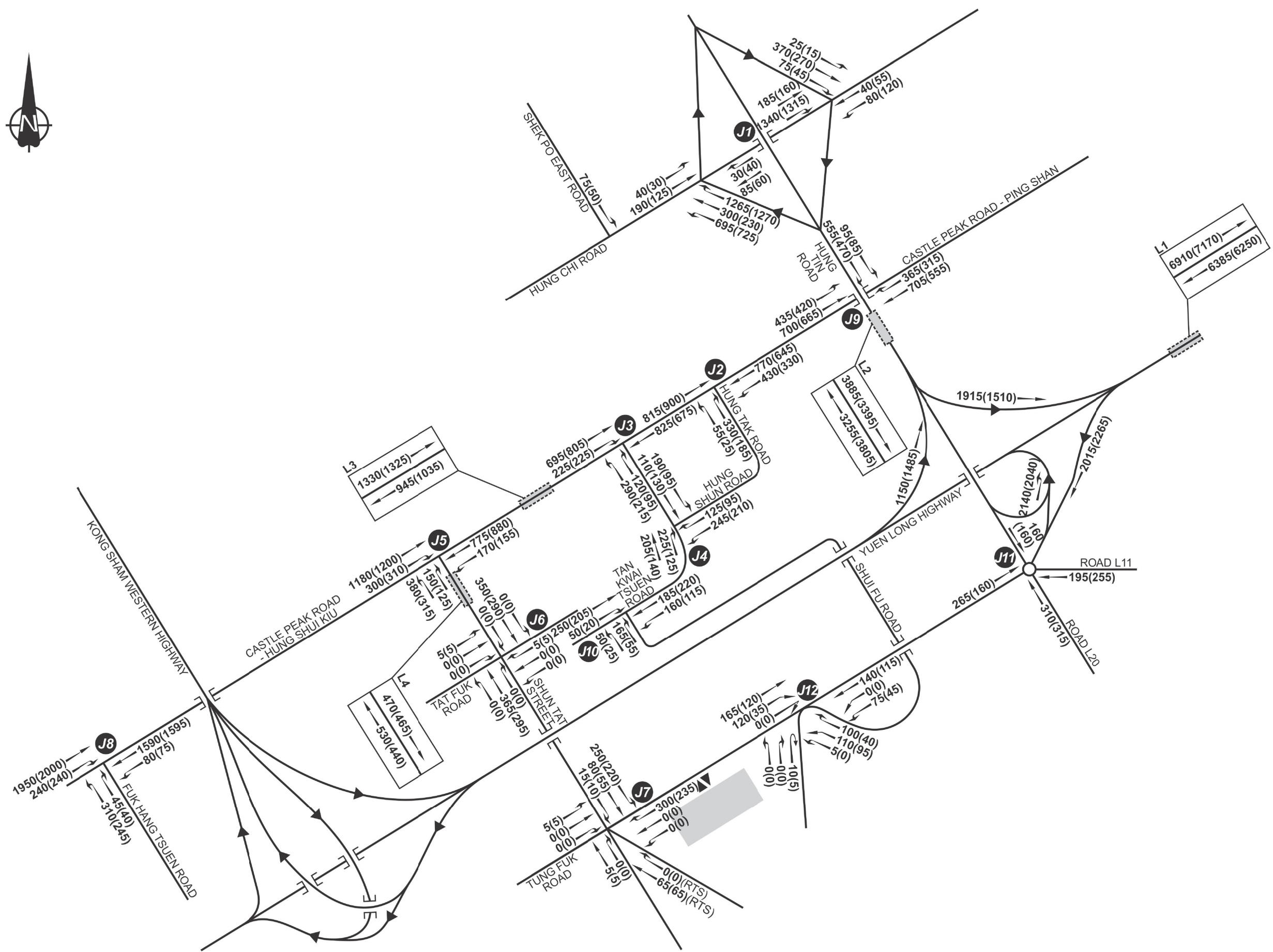

**LEGEND :**  
 [Grey Box] SUBJECT SITE  
 2015(2265) AM(PM) PEAK HOUR TRAFFIC FLOW (PCU/HR)

Revision	Date	Description	Initial
B	13SEP22	TD COMMENTS INCORPORATED	TKM
A	27MAY22	ROAD NETWORK UPDATED	TKM
	Designed	Checked	Drawn
Initial	-	-	-
Date	-	-	-

Agreement no. CE 92/2017 (CE)

**TITLE**  
 SITE FORMATION AND INFRASTRUCTURE WORKS FOR PUBLIC HOUSING DEVELOPMENT NEAR TAN KWAI TSUEN, YUEN LONG - INVESTIGATION, DESIGN AND CONSTRUCTION

**Drawing Title**  
 2034 DESIGN TRAFFIC FLOWS

Drawing No.	Scale
4.4	N.T.S. (A3)

土木工程拓展署  
**CEDD** Civil Engineering and Development Department

**binnies**  
 BINNIES HONG KONG LIMITED  
 賓尼士工程顧問有限公司



PROPOSED METHOD OF CONTROL

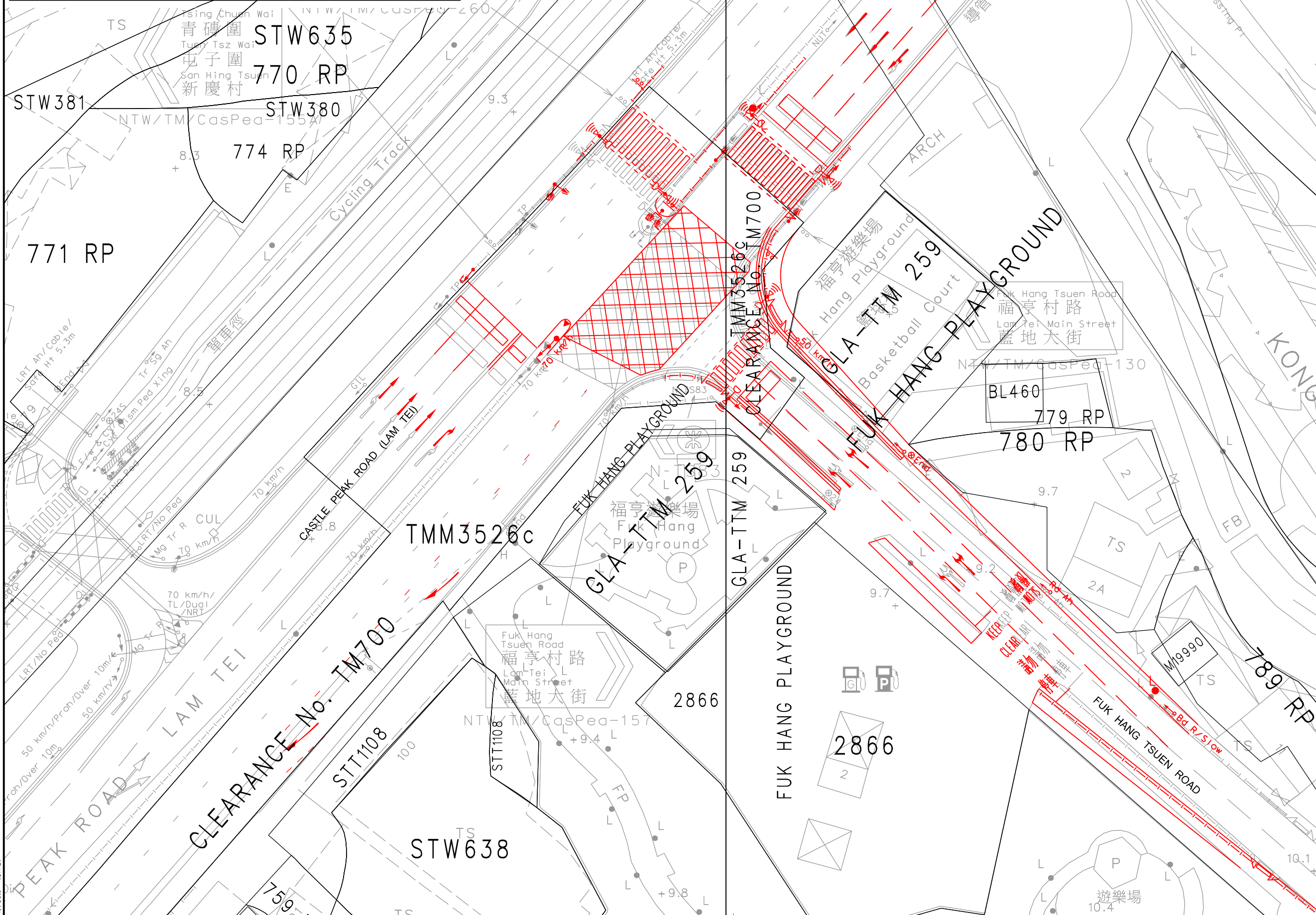
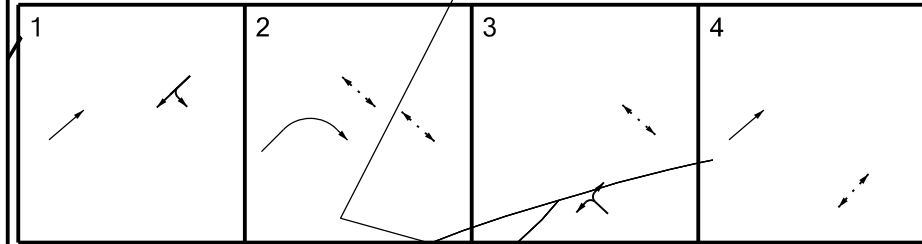

© Copyright by Black & Veatch Hong Kong Limited

Revision	Date	Description			Initial
		Designed	Checked	Drawn	
Initial	-	-	-	-	-
Date	-	-	-	-	-

Agreement No.  
CE 92/2017 (CE)

Agreement title  
SITE FORMATION AND INFRASTRUCTURAL WORKS FOR THE DEVELOPMENT NEAR TAN KWAI TSUEN, YUEN LONG - INVESTIGATION, DESIGN AND CONSTRUCTION

Figure title  
PROPOSED IMPROVEMENT SCHEME AT JUNCTION OF CASTLE PEAK ROAD - LAM TEI/FUK HANG TSUEN ROAD (J8)

Figure no.	Revision
5.1	-

Scale  
1 : 500 (A3)

土木工程拓展署  
CEDD Civil Engineering and Development Department

binies  
BINNIES HONG KONG LIMITED  
賓尼士工程顧問有限公司  
SYSTRA

Plot Date : 20/01/22

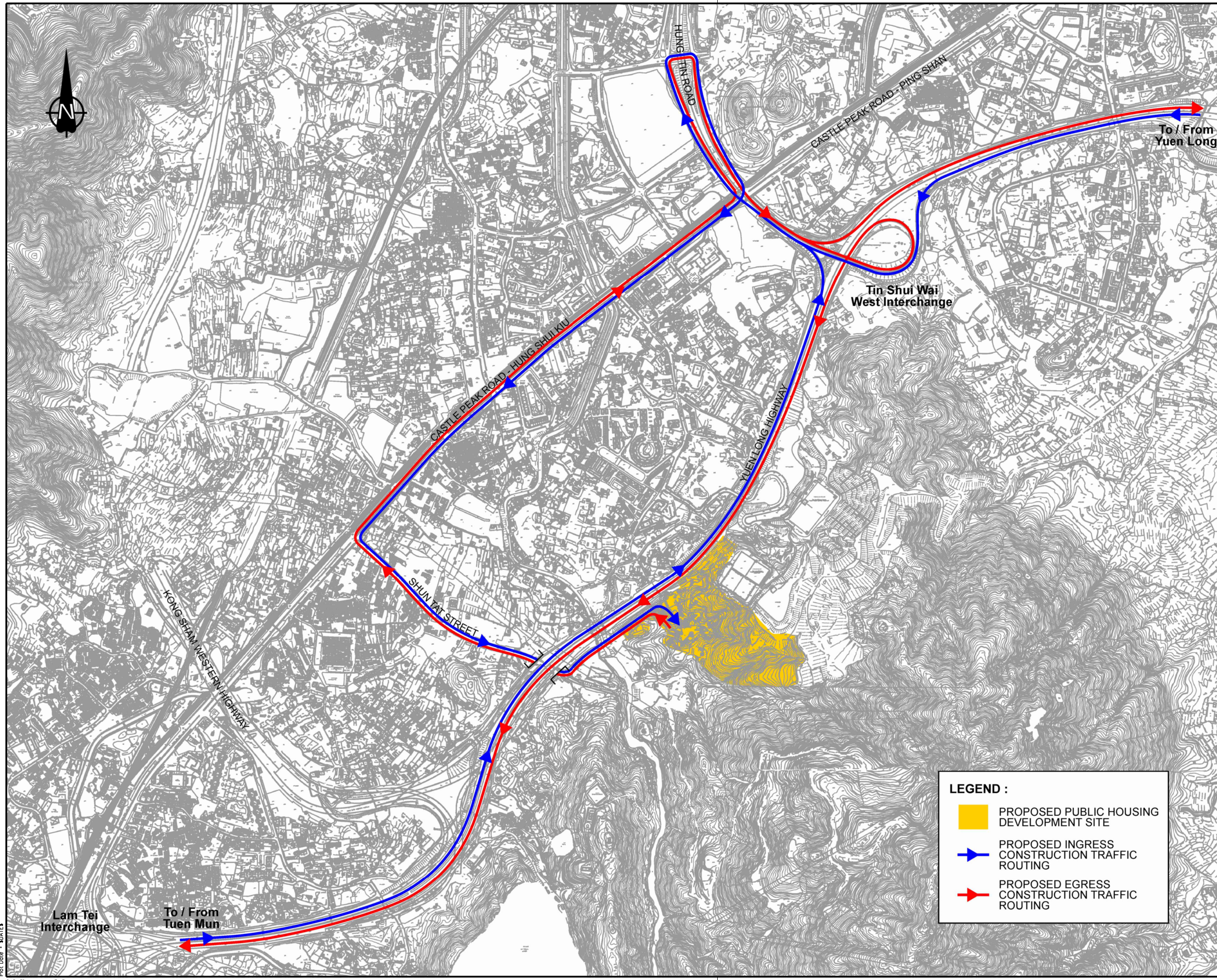

**LEGEND :**

- PROPOSED PUBLIC HOUSING DEVELOPMENT SITE
- PROPOSED INGRESS CONSTRUCTION TRAFFIC ROUTING
- PROPOSED EGRESS CONSTRUCTION TRAFFIC ROUTING

Revision	Date	Description	Initial
	Designed	Checked	Drawn
Initial	-	-	-
Date	-	-	-

Agreement No. CE 92/2017 (CE)

Agreement title  
 SITE FORMATION AND INFRASTRUCTURAL WORKS FOR THE DEVELOPMENT NEAR TAN KWAI TSUEN, YUEN LONG - INVESTIGATION, DESIGN AND CONSTRUCTION

Figure title  
 PROPOSED CONSTRUCTION TRAFFIC ROUTE BEFORE PROPOSED ACCESS ROAD ALONG YUEN LONG HIGHWAY IN PLACE

Figure no.	Revision
5.2	-

Scale 1 : 500 (A3)

土木工程拓展署  
**CEDD** Civil Engineering and Development Department

**binnies**  
 BINNIES HONG KONG LIMITED  
 賓尼新工程顧問有限公司  
**SYSTRA**  
 MVA

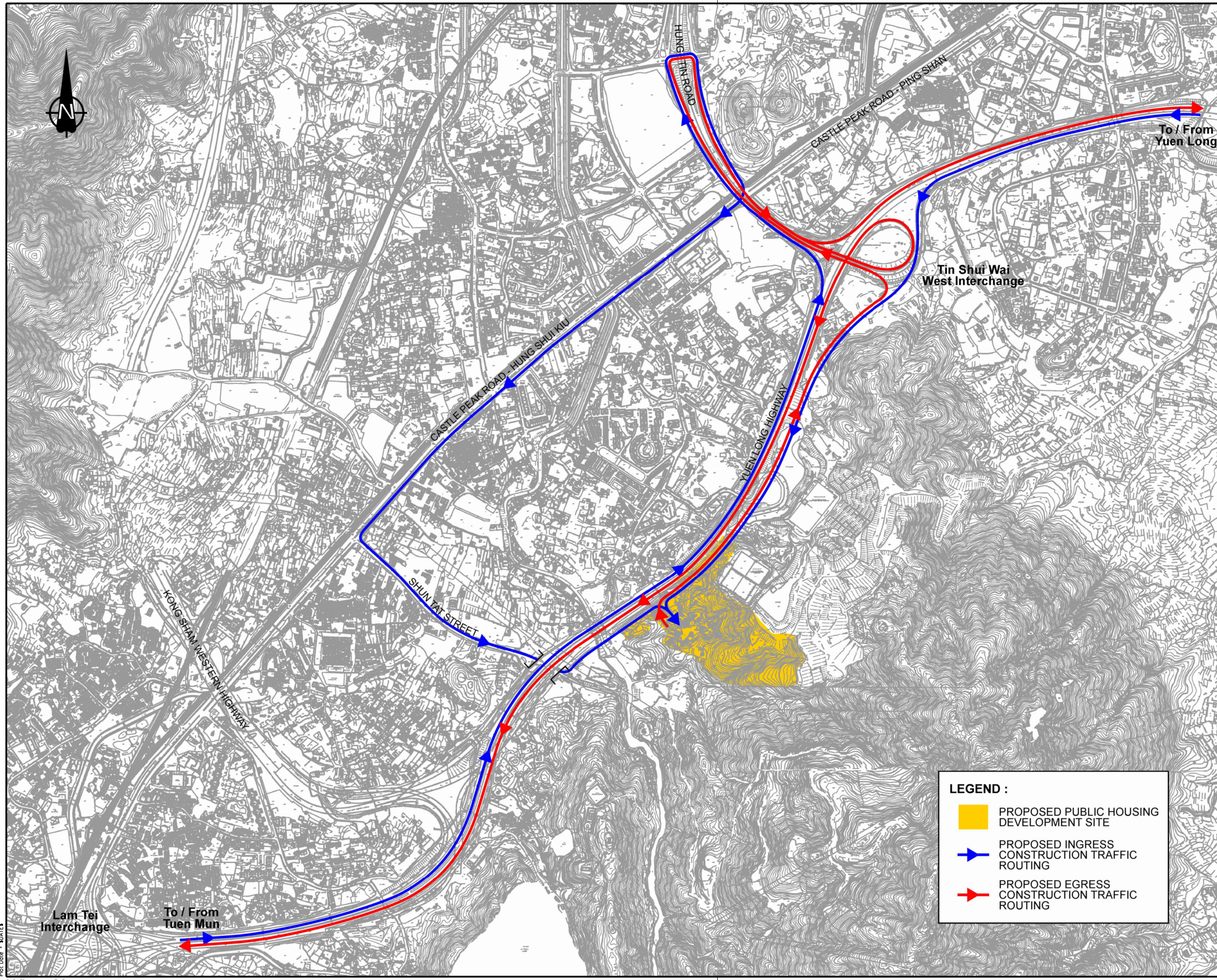

**LEGEND :**

- PROPOSED PUBLIC HOUSING DEVELOPMENT SITE
- PROPOSED INGRESS CONSTRUCTION TRAFFIC ROUTING
- PROPOSED EGRESS CONSTRUCTION TRAFFIC ROUTING

Revision	Date	Description	Initial
		Designed	Checked
		Checked	Drawn
		Drawn	Checked
		Date	

Agreement No. CE 92/2017 (CE)

Agreement title  
 SITE FORMATION AND INFRASTRUCTURAL WORKS FOR THE DEVELOPMENT NEAR TAN KWAI TSUEN, YUEN LONG - INVESTIGATION, DESIGN AND CONSTRUCTION

Figure title  
 PROPOSED CONSTRUCTION TRAFFIC ROUTE AFTER PROPOSED ACCESS ROAD ALONG YUEN LONG HIGHWAY IN PLACE

Figure no.	Revision
5.3	-

Scale 1 : 500 (A3)

土木工程拓展署  
**CEDD** Civil Engineering and Development Department

**binnes**  
 BINNIES HONG KONG LIMITED  
 賓尼新工程顧問有限公司  
**SYSTRA**  
 MVA

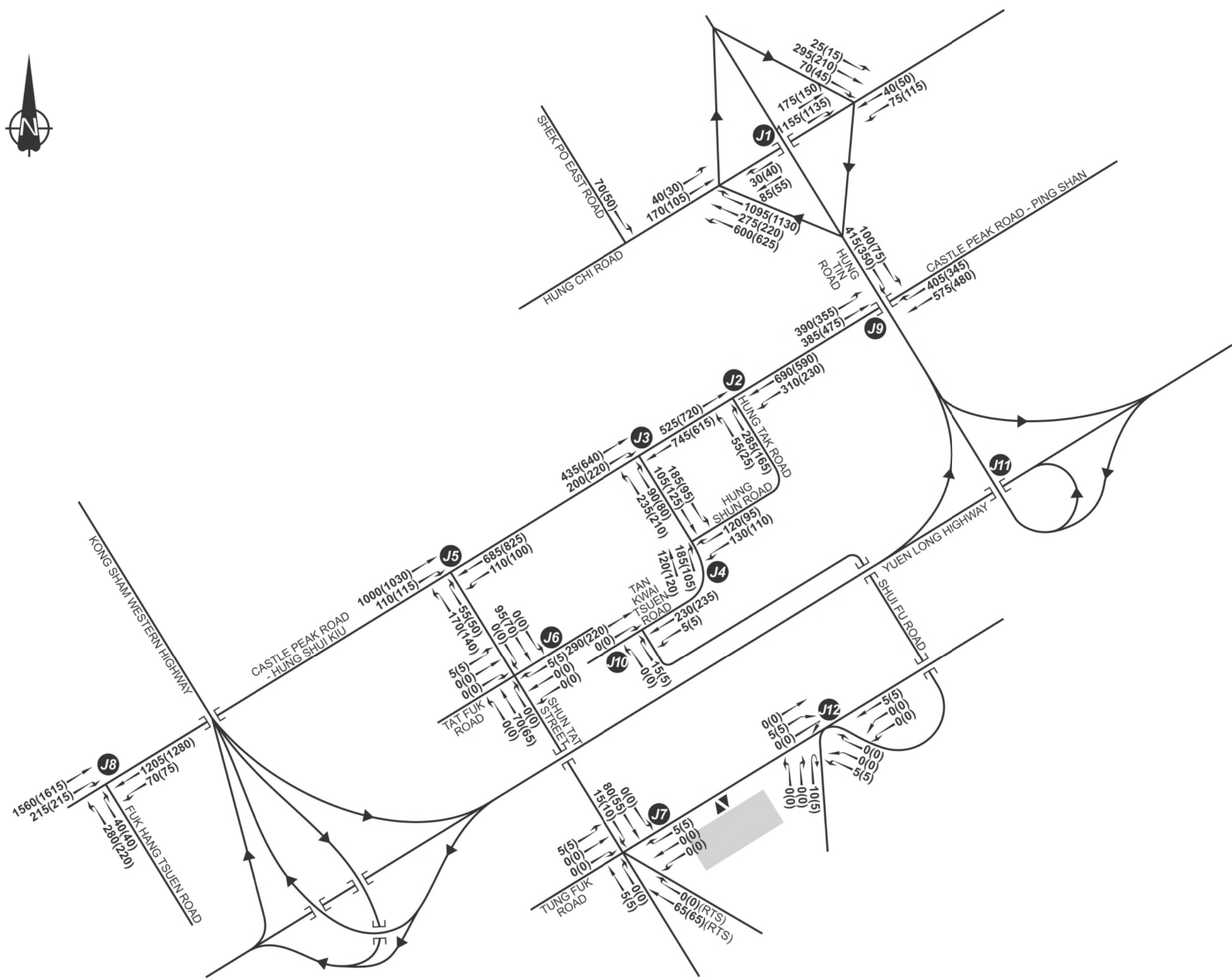

**LEGEND :**  
 [Grey Box] SUBJECT SITE  
 405(345) AM(PM) PEAK HOUR TRAFFIC FLOW (PCU/HR)

Revision	Date	Description	Initial
Initial	-	-	-
Date	-	-	-

Approved

Agreement no. CE 92/2017 (CE)

Title  
 SITE FORMATION AND INFRASTRUCTURE WORKS FOR PUBLIC HOUSING DEVELOPMENT NEAR TAN KWAI TSUEN, YUEN LONG - INVESTIGATION, DESIGN AND CONSTRUCTION

Drawing Title  
 2030 REFERENCE TRAFFIC FLOWS

Drawing No.	Scale
5.4	N.T.S. (A3)

土木工程拓展署  
**CEDD** Civil Engineering and Development Department

**binnies**  
 BINNIES HONG KONG LIMITED  
 賓尼士工程顧問有限公司

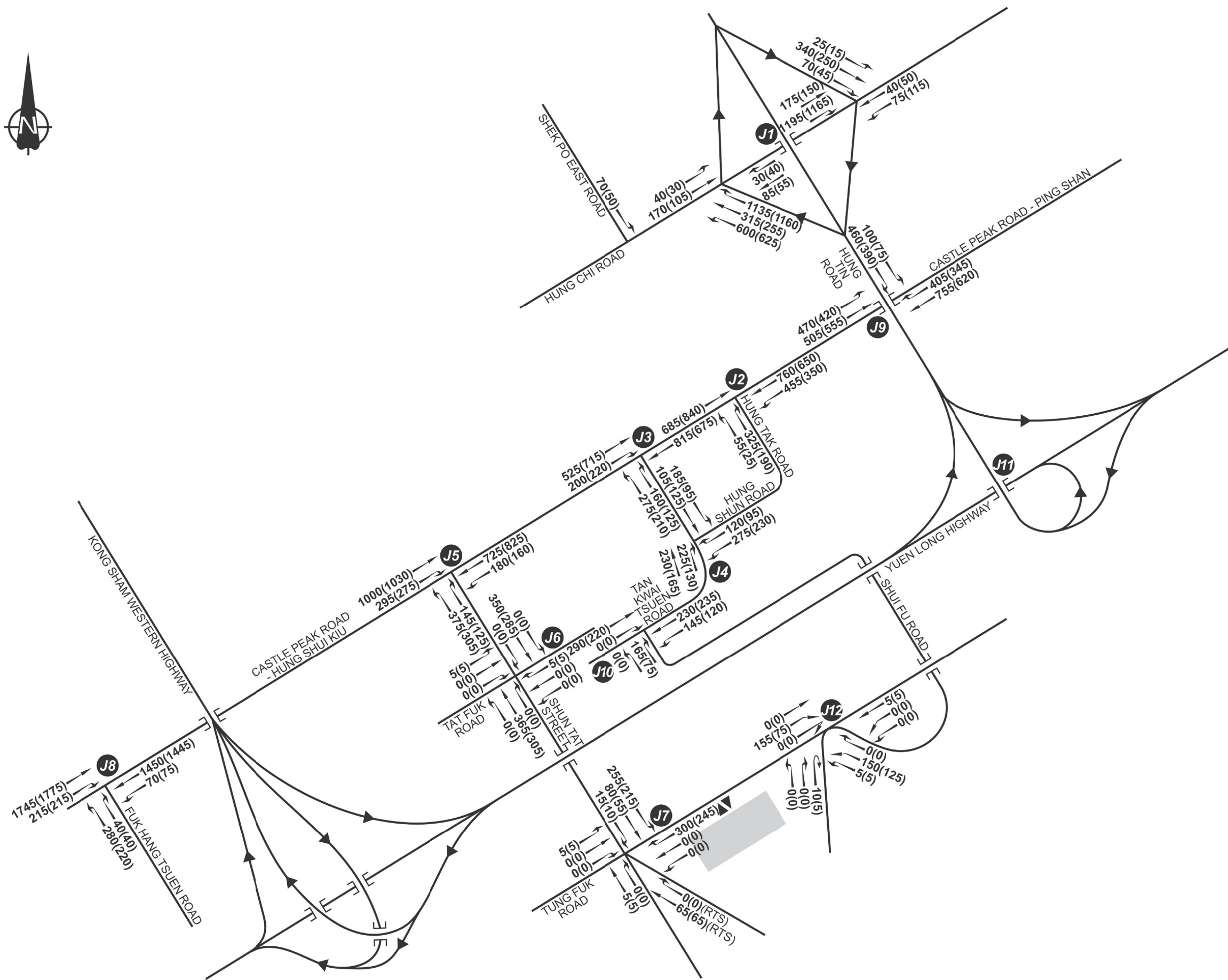

**LEGEND :**

■ SUBJECT SITE

405(345) AM(PM) PEAK HOUR TRAFFIC FLOW (PCU/HR)

Revision	Date	Description	Initial
Designed		Checked	Drawn
Initial	-	-	-
Date	-	-	-

Approved

Agreement no. CE 92/2017 (CE)

Title  
SITE FORMATION AND INFRASTRUCTURE WORKS FOR PUBLIC HOUSING DEVELOPMENT NEAR TAN KWAI TSUEN, YUEN LONG - INVESTIGATION, DESIGN AND CONSTRUCTION

Drawing Title  
2030 DESIGN TRAFFIC FLOWS

Drawing No.	Scale
5.5	N.T.S. (A3)

土木工程拓展署  
CEDD Civil Engineering and Development Department

binnies  
BINNIES HONG KONG LIMITED  
賓尼士工程顧問有限公司

LEGEND:  
 WATER BARRIER

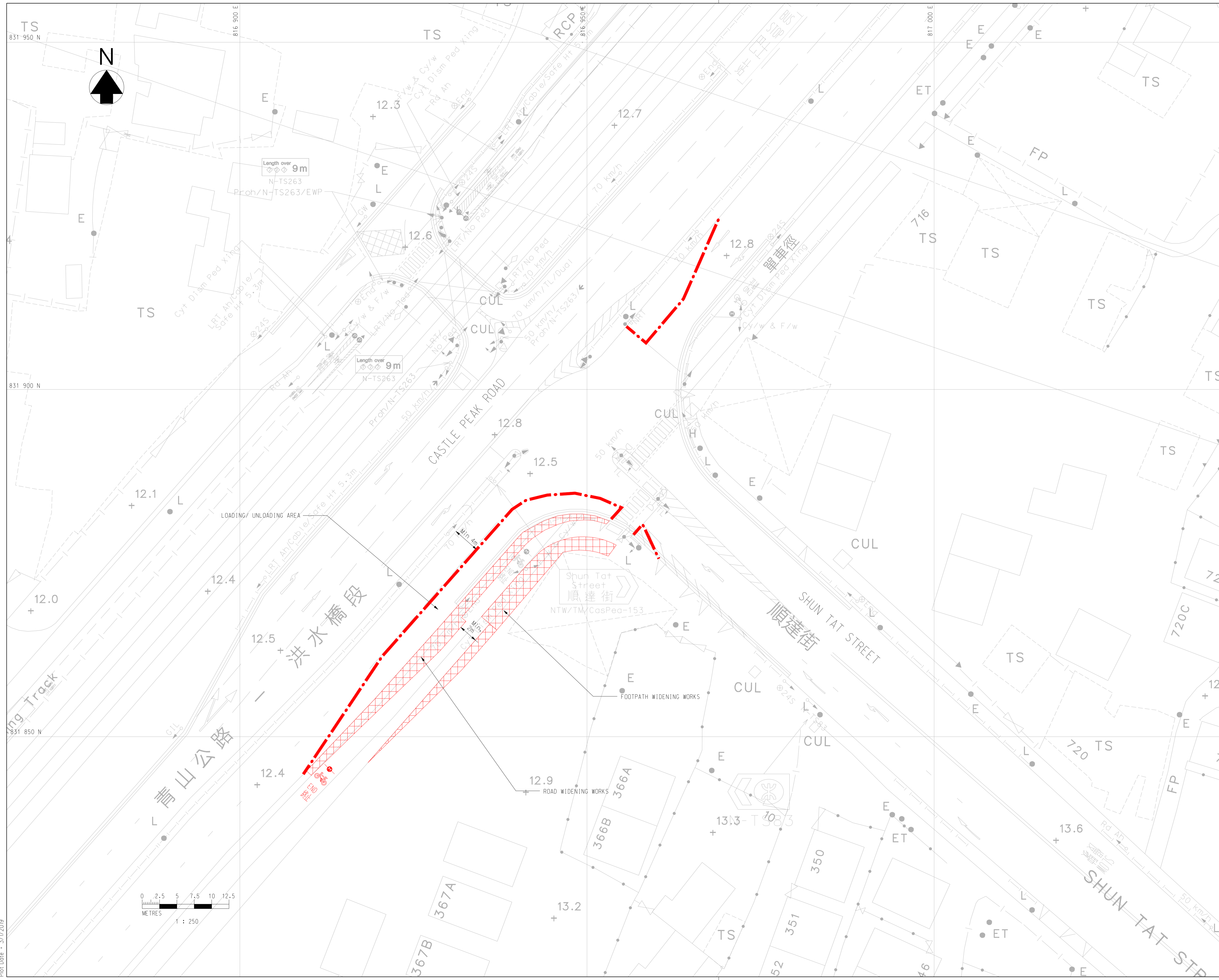

Revision	Date	Description	Initial
	Designed	Checked	Drawn
Initial	KWM	LCH	SZ
Date	02/19	02/19	02/19

Approved

Agreement no.  
CE 92/2017 (CE)

Project Title  
SITE FORMATION AND INFRASTRUCTURE WORKS FOR PUBLIC HOUSING DEVELOPMENT NEAR TAN KWAI TSUEN, YUEN LONG - INVESTIGATION, DESIGN AND CONSTRUCTION

Drawing Title  
TEMPORARY TRAFFIC MANAGEMENT AT JUNCTION OF CASTLE PEAK ROAD - HUNG SHUI KIU / SHUN TAT STREET (J5) - STAGE 1

Drawing No. 6.1	Scale 1 : 250 (A1) 1 : 500 (A3)
--------------------	---------------------------------------

土木工程拓展署  
**CEDD Civil Engineering and Development Department**

  
 BINNIES HONG KONG LIMITED  
 賓尼士工程顧問有限公司

LEGEND:  
 WATER BARRIER

Revision	Date	Description	Initial
	Designed	Checked	Drawn
Initial	KWM	LCH	SZ
Date	02/19	02/19	02/19
Approved			

Agreement no.  
CE 92/2017 (CE)

Project Title  
SITE FORMATION AND INFRASTRUCTURE WORKS FOR PUBLIC HOUSING DEVELOPMENT NEAR TAN KWAI TSUEN, YUEN LONG - INVESTIGATION, DESIGN AND CONSTRUCTION

Drawing Title  
TEMPORARY TRAFFIC MANAGEMENT AT JUNCTION OF CASTLE PEAK ROAD - HUNG SHUI KIU / SHUN TAT STREET (J5) - STAGE 2

Drawing No.	Scale
6.2	1 : 250 (A1) 1 : 500 (A3)

土木工程拓展署  
 **CEDD Civil Engineering and Development Department**

  
 BINNIES HONG KONG LIMITED  
 賓尼士工程顧問有限公司

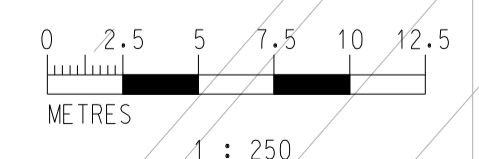
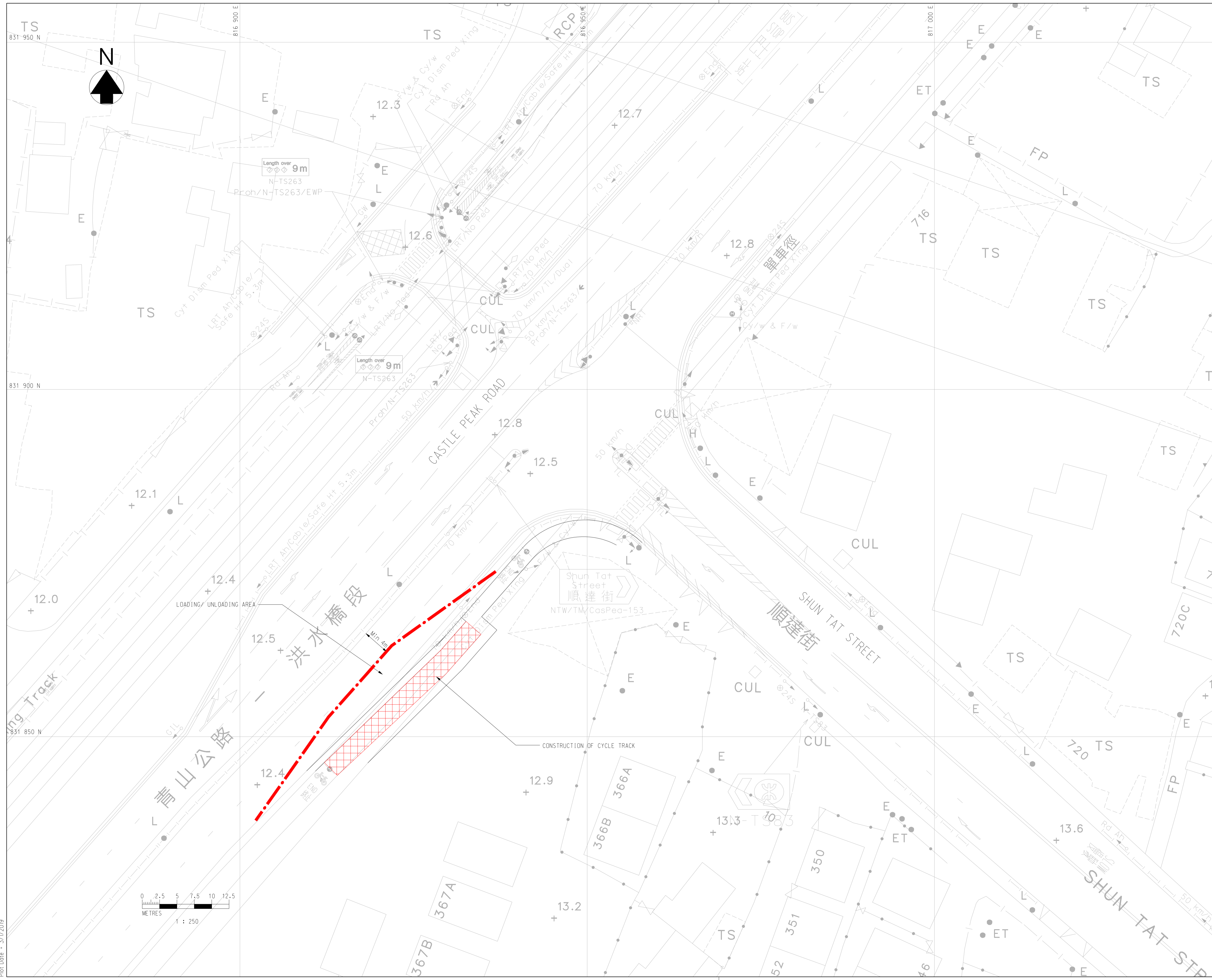





LEGEND:  
 WATER BARRIER

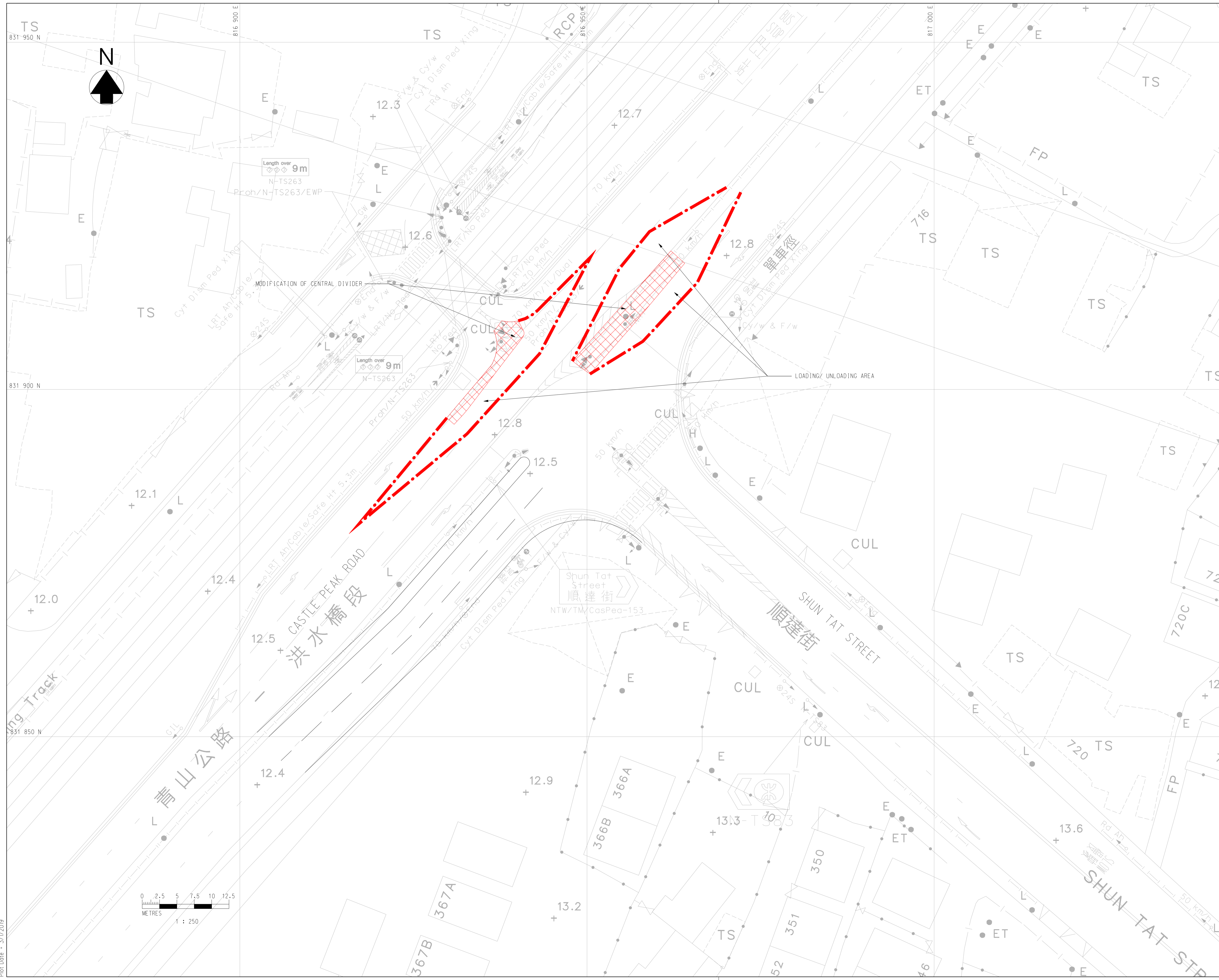

Revision	Date	Description	Initial
Initial	Designed	Checked	Drawn
Initial	KWM	LCH	SZ
Date	02/19	02/19	02/19
Approved			

Agreement no.  
CE 92/2017 (CE)

Project Title  
SITE FORMATION AND INFRASTRUCTURE WORKS FOR PUBLIC HOUSING DEVELOPMENT NEAR TAN KWAI TSUEN, YUEN LONG - INVESTIGATION, DESIGN AND CONSTRUCTION

Drawing Title  
TEMPORARY TRAFFIC MANAGEMENT AT JUNCTION OF CASTLE PEAK ROAD - HUNG SHUI KIU / SHUN TAT STREET (J5) - STAGE 4

Drawing No.	Scale
6.4	1 : 250 (A1) 1 : 500 (A3)

土木工程拓展署  
**CEDD Civil Engineering and Development Department**

  
 BINNIES HONG KONG LIMITED  
 賓尼士工程顧問有限公司

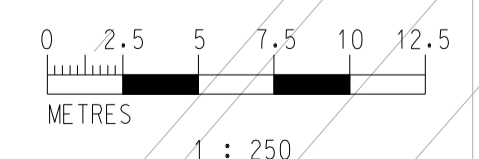

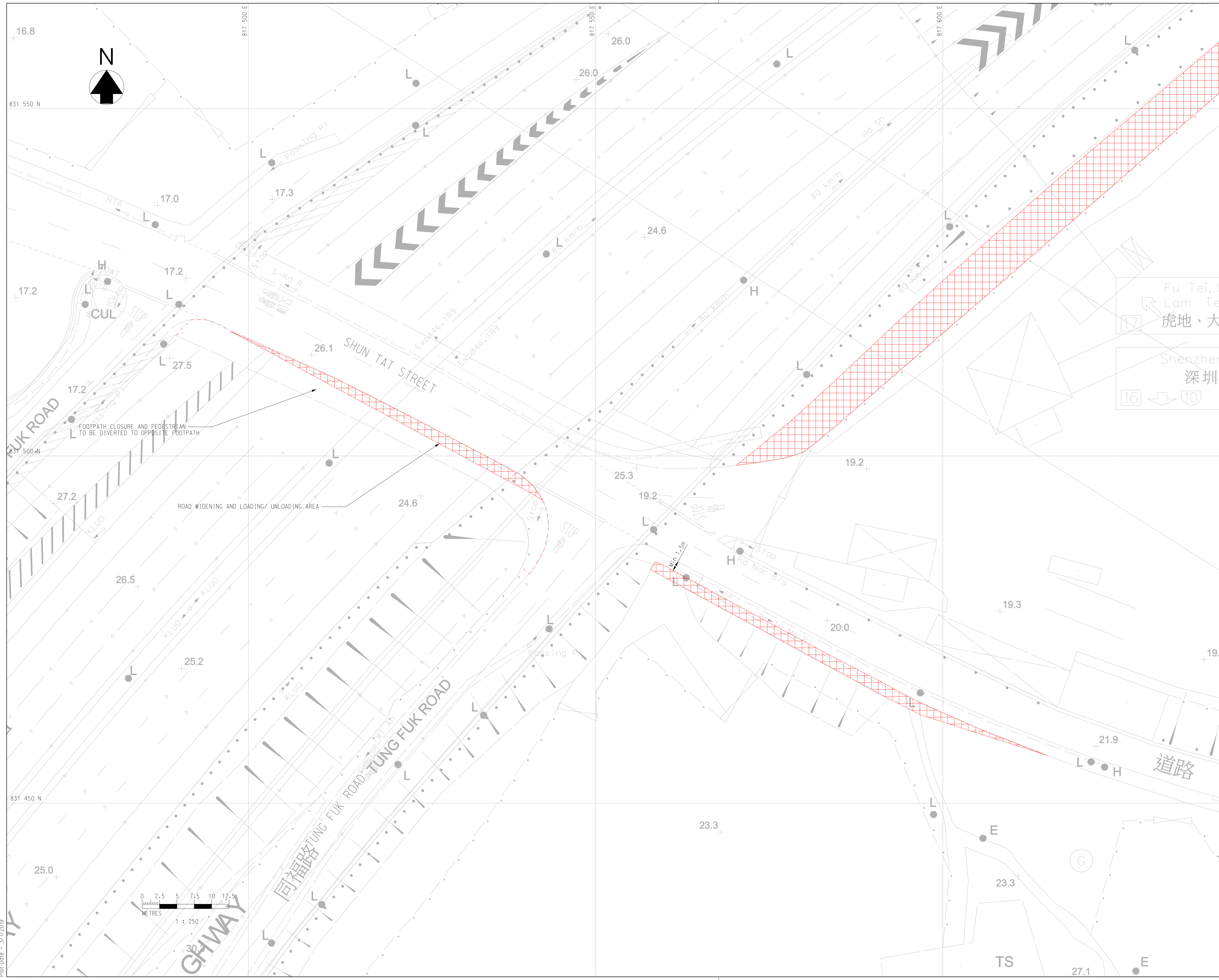

Revision	Date	Description			Initial
		Designed	Checked	Drawn	Checked
Initial		KWM	LCH	SZ	LCH
Date	02/19	02/19	02/19	02/19	02/19

Approved

Agreement no.  
CE 92/2017 (CE)

Project Title  
SITE FORMATION AND INFRASTRUCTURE WORKS FOR PUBLIC HOUSING DEVELOPMENT NEAR TAN KWAI TSUEN, YUEN LONG - INVESTIGATION, DESIGN AND CONSTRUCTION

Drawing Title  
TEMPORARY TRAFFIC MANAGEMENT AT JUNCTION OF SHUN TAT STREET / PROPOSED ACCESS ROAD / TUNG FUK ROAD (J7) - STAGE 1

Drawing No.	Scale
6.5	1 : 250 (A1) 1 : 500 (A3)

土木工程拓展署  
**CEDD Civil Engineering and Development Department**

**binnies**  
BINNIES HONG KONG LIMITED  
賓尼士工程顧問有限公司

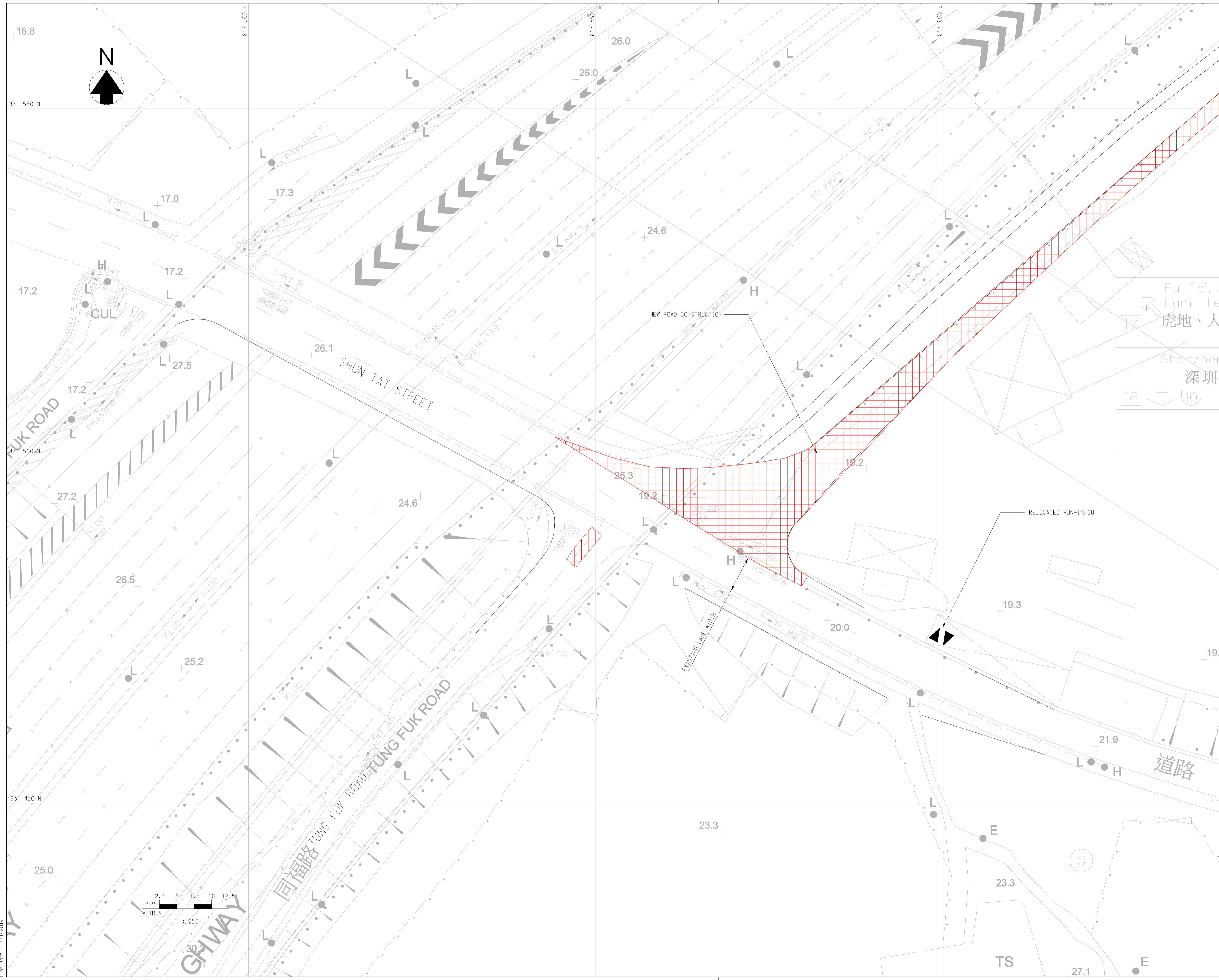

Revision	Date	Description			Initial
		Designed	Checked	Drawn	Checked
Initial		KWM	LCH	SZ	LCH
Date	02/19	02/19	02/19	02/19	02/19

Approved

Agreement no. CE 92/2017 (CE)

Project Title  
SITE FORMATION AND INFRASTRUCTURE WORKS FOR PUBLIC HOUSING DEVELOPMENT NEAR TAN KWAI TSUEN, YUEN LONG - INVESTIGATION, DESIGN AND CONSTRUCTION

Drawing Title  
TEMPORARY TRAFFIC MANAGEMENT AT JUNCTION OF SHUN TAT STREET / PROPOSED ACCESS ROAD / TUNG FUK ROAD (J7) - STAGE 2

Drawing No.	Scale
6.6	1 : 250 (A1) 1 : 500 (A3)

土木工程拓展署  
**CEDD Civil Engineering and Development Department**

**binnies**  
BINNIES HONG KONG LIMITED  
賓尼士工程顧問有限公司

Plot Date - 3/1/2019

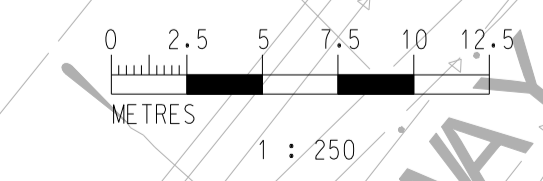

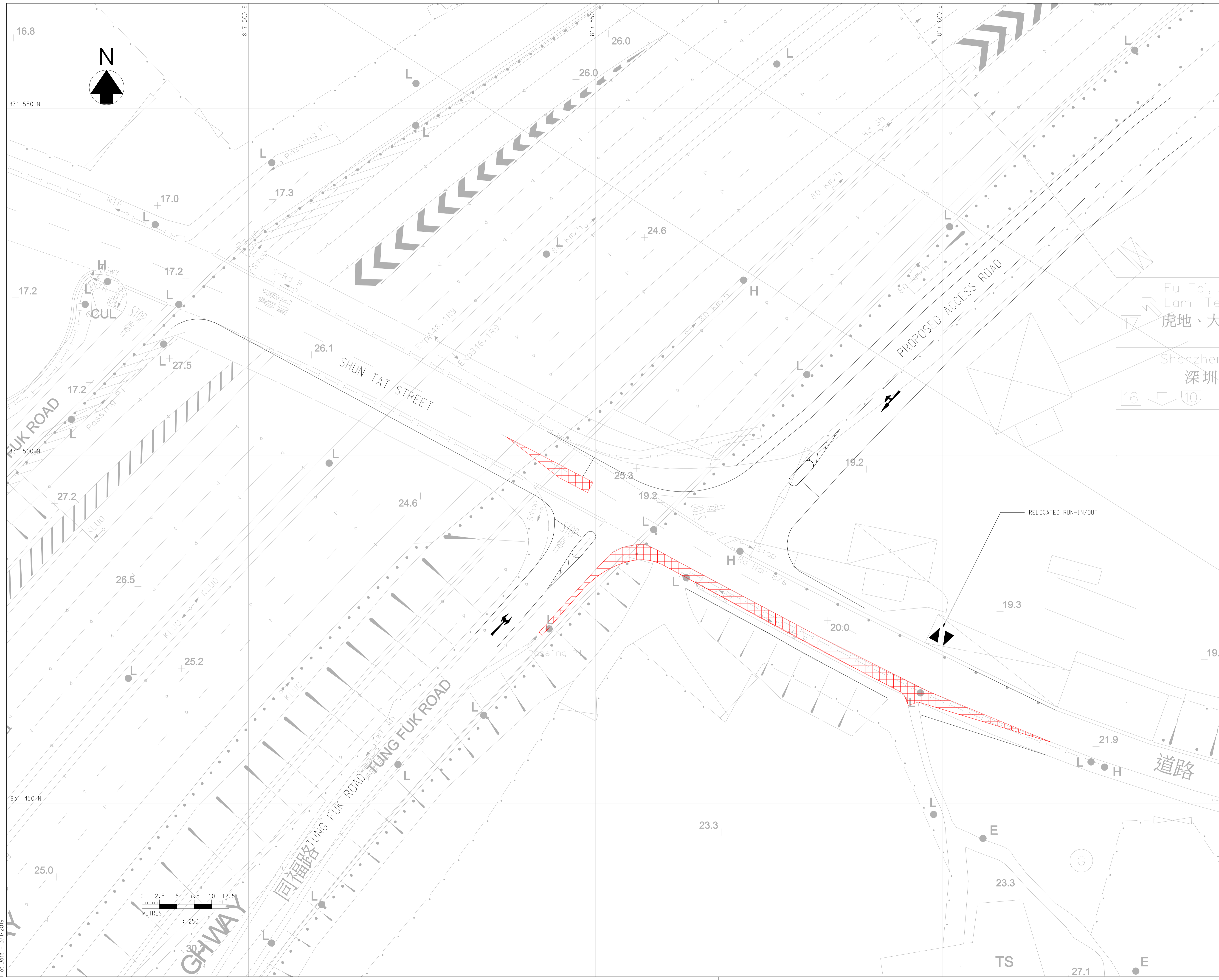

Revision	Date	Description			Initial
		Designed	Checked	Drawn	Checked
Initial		KWM	LCH	SZ	LCH
Date	02/19	02/19	02/19	02/19	02/19

Approved

Agreement no.  
CE 92/2017 (CE)

Project Title  
SITE FORMATION AND INFRASTRUCTURE WORKS FOR PUBLIC HOUSING DEVELOPMENT NEAR TAN KWAI TSUEN, YUEN LONG - INVESTIGATION, DESIGN AND CONSTRUCTION

Drawing Title  
TEMPORARY TRAFFIC MANAGEMENT AT JUNCTION OF SHUN TAT STREET / PROPOSED ACCESS ROAD / TUNG FUK ROAD (J7) - STAGE 3

Drawing No. 6.7	Scale 1 : 250 (A1) 1 : 500 (A3)
--------------------	---------------------------------------

土木工程拓展署  
**CEDD Civil Engineering and Development Department**

**binnies**  
BINNIES HONG KONG LIMITED  
賓尼士工程顧問有限公司

LEGEND:  
 WATER BARRIER

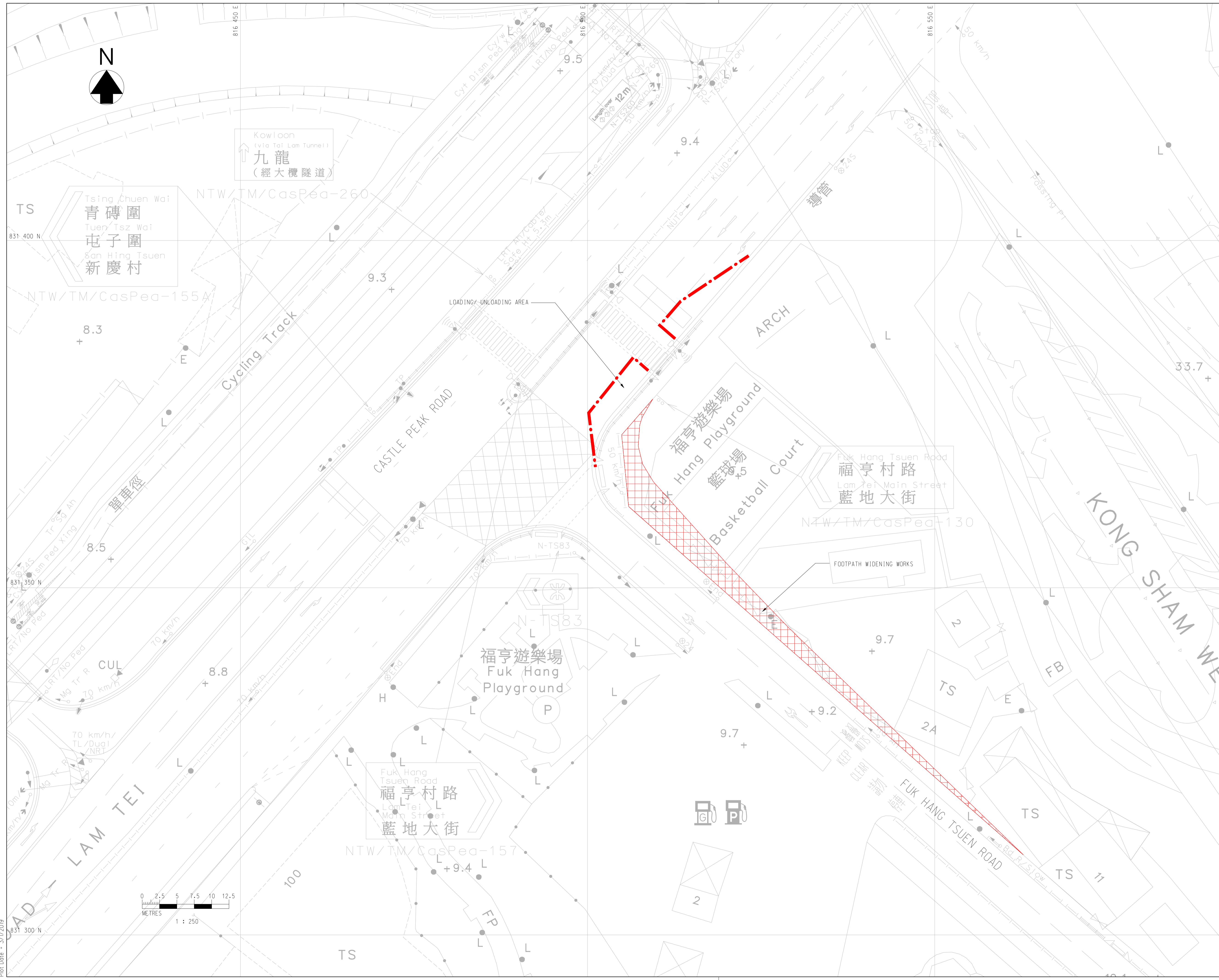

Revision	Date	Description	Initial
Initial	KWM	LCH SZ	LCH
Date	02/19	02/19	02/19

Approved

Agreement no. CE 92/2017 (CE)

Project Title  
 SITE FORMATION AND INFRASTRUCTURE WORKS FOR PUBLIC HOUSING DEVELOPMENT NEAR TAN KWAI TSUEN, YUEN LONG - INVESTIGATION, DESIGN AND CONSTRUCTION

Drawing Title  
 TEMPORARY TRAFFIC MANAGEMENT AT JUNCTION OF CASTLE PEAK ROAD - LAM TEI / FUK HANG TSUEN ROAD (J8) - STAGE 1

Drawing No.	Scale
6.8	1 : 250 (A1) 1 : 500 (A3)

土木工程拓展署  
**CEDD Civil Engineering and Development Department**

  
 BINNIES HONG KONG LIMITED  
 賓尼士工程顧問有限公司

LEGEND:  
 WATER BARRIER

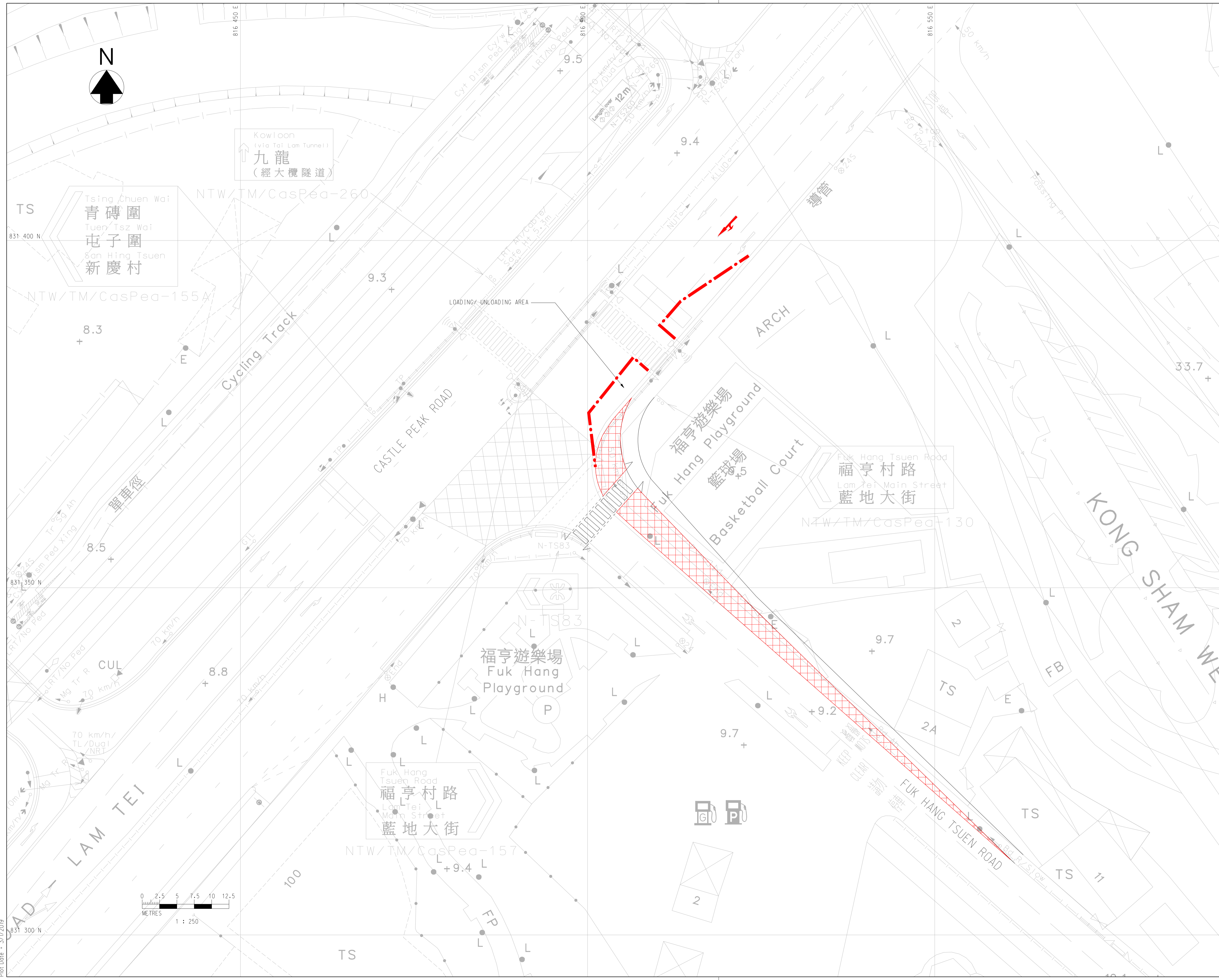

Revision	Date	Description	Initial
Initial	KWM	LCH SZ	LCH
Date	02/19	02/19	02/19

Agreement no. CE 92/2017 (CE)

Project Title  
 SITE FORMATION AND INFRASTRUCTURE WORKS FOR PUBLIC HOUSING DEVELOPMENT NEAR TAN KWAI TSUEN, YUEN LONG - INVESTIGATION, DESIGN AND CONSTRUCTION

Drawing Title  
 TEMPORARY TRAFFIC MANAGEMENT AT JUNCTION OF CASTLE PEAK ROAD - LAM TEI / FUK HANG TSUEN ROAD (J8) - STAGE 2

Drawing No.	Scale
6.9	1 : 250 (A1) 1 : 500 (A3)

土木工程拓展署  
**CEDD Civil Engineering and Development Department**

  
 BINNIES HONG KONG LIMITED  
 賓尼士工程顧問有限公司

LEGEND:  
 WATER BARRIER

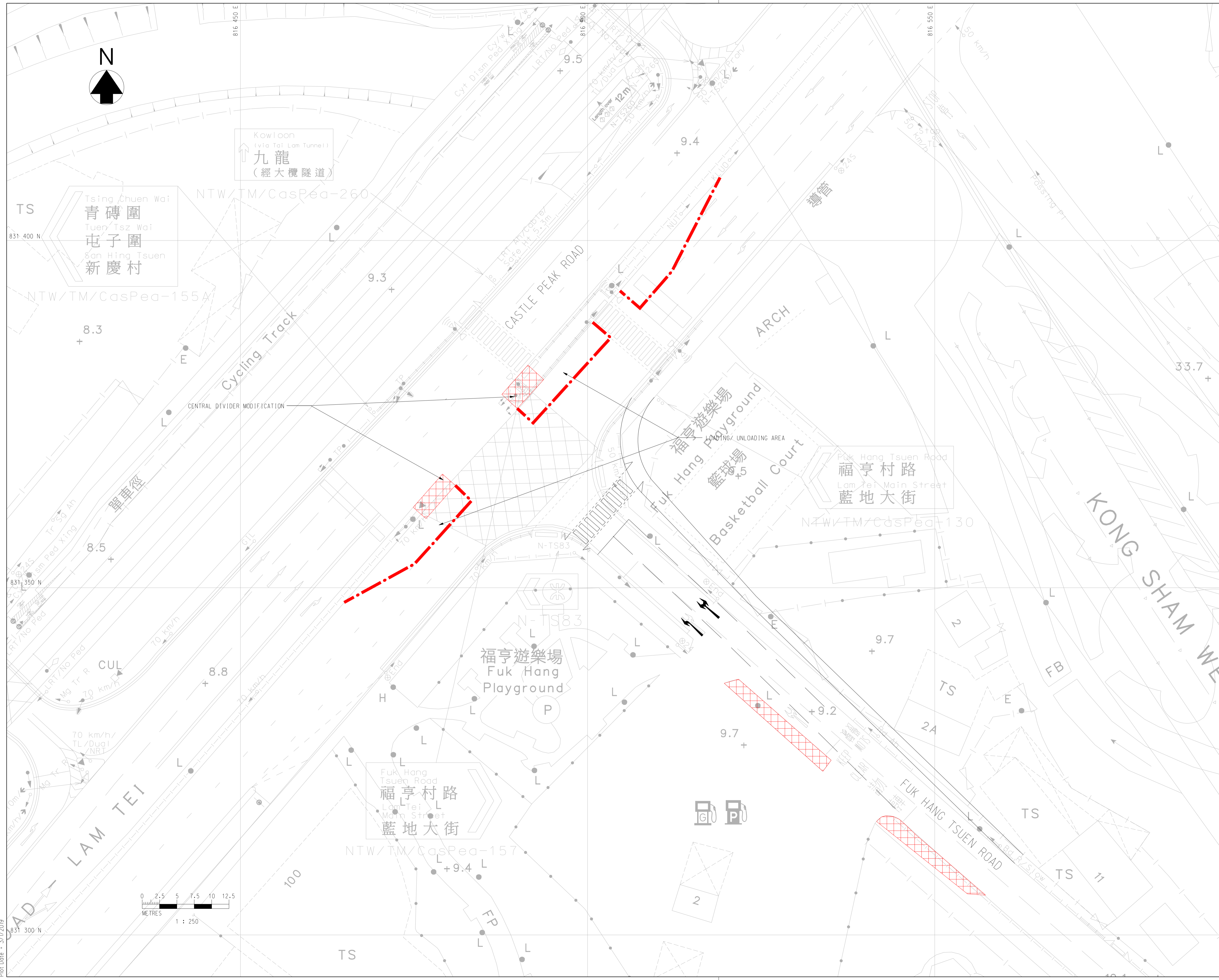

Revision	Date	Description	Initial
Initial	KWM	LCH SZ	LCH
Date	02/19	02/19	02/19

Approved

Agreement no. CE 92/2017 (CE)

Project Title  
 SITE FORMATION AND INFRASTRUCTURE WORKS FOR PUBLIC HOUSING DEVELOPMENT NEAR TAN KWAI TSUEN, YUEN LONG - INVESTIGATION, DESIGN AND CONSTRUCTION

Drawing Title  
 TEMPORARY TRAFFIC MANAGEMENT AT JUNCTION OF CASTLE PEAK ROAD - LAM TEI / FUK HANG TSUEN ROAD (J8) - STAGE 3

Drawing No. 6.10	Scale 1 : 250 (A1) 1 : 500 (A3)
------------------	------------------------------------

土木工程拓展署  
**CEDD** Civil Engineering and Development Department

  
 BINNIES HONG KONG LIMITED  
 賓尼士工程顧問有限公司

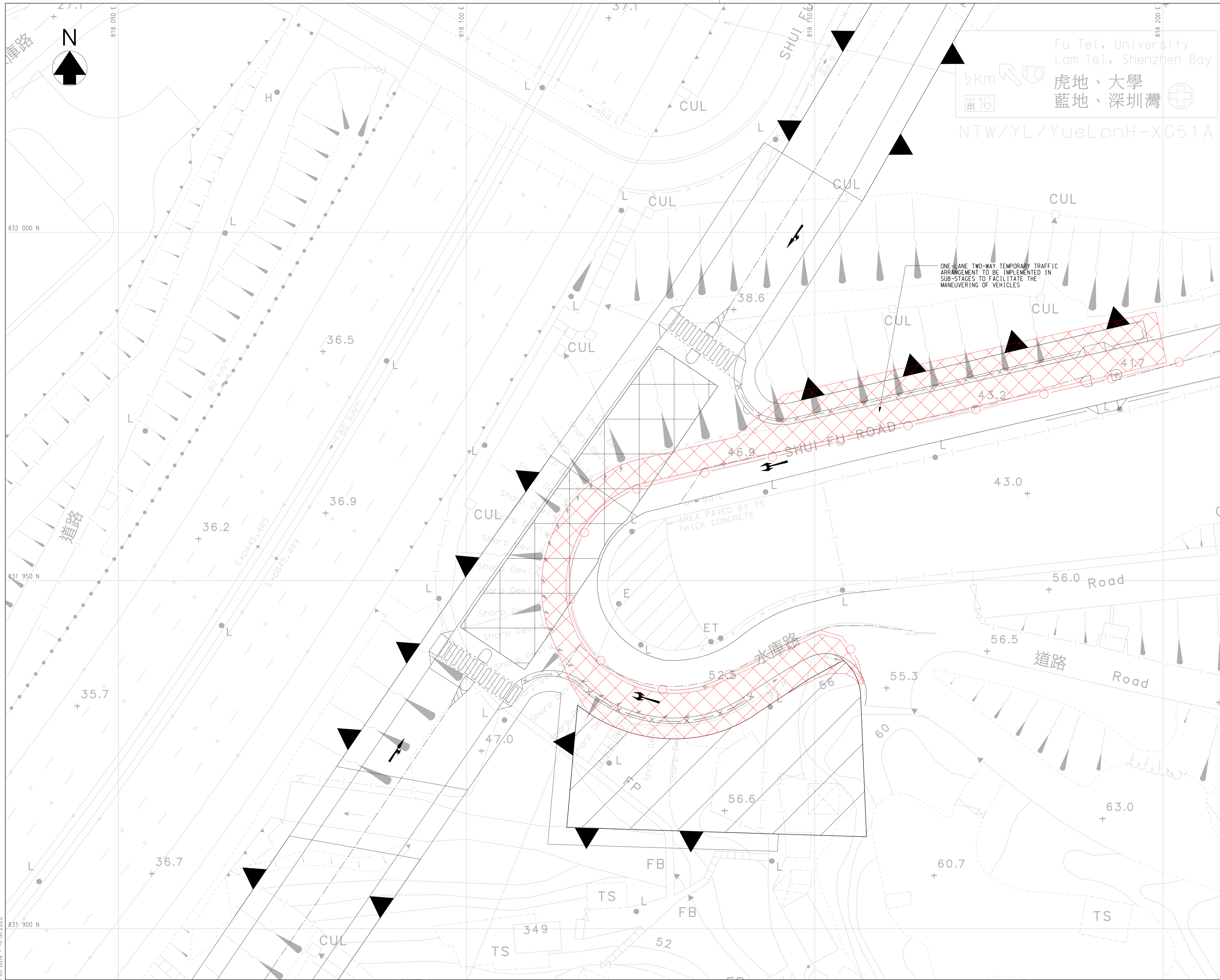

**LEGEND:**

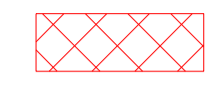
-  TRAFFIC CONES WITH FLASHING LIGHTS
-  WORKS AREA

Fu Tei, University  
Lam Tei, Shenzhen Bay

虎地、大學  
藍地、深圳灣

NTW/YL/YueLonH-XG51A

2km

16

ONE-LANE TWO-WAY TEMPORARY TRAFFIC ARRANGEMENT TO BE IMPLEMENTED IN SUB-STAGES TO FACILITATE THE MANEUVERING OF VEHICLES

AREA PAVED BY 75 THICK CONCRETE

Revision	Date	Description			Initial
		Designed	Checked	Drawn	Checked
Initial	KCC	SFL	SZ	SFL	
Date	11/20	11/20	11/20	11/20	11/20

Agreement no. CE 92/2017 (CE)

Agreement title  
SITE FORMATION AND INFRASTRUCTURE WORKS FOR PUBLIC HOUSING DEVELOPMENT NEAR TAN KWAI TSUEN, YUEN LONG - INVESTIGATION, DESIGN AND CONSTRUCTION

Figure title  
TEMPORARY TRAFFIC MANAGEMENT AT JUNCTION OF SHUI FU ROAD / PROPOSED ACCESS ROAD (J12) - STAGE 1

Figure no.	Scale
6.11	1 : 250 (A1) 1 : 500 (A3)

土木工程拓展署  
**CEDD** Civil Engineering and Development Department

  
BINNIES HONG KONG LIMITED  
賓尼士工程顧問有限公司



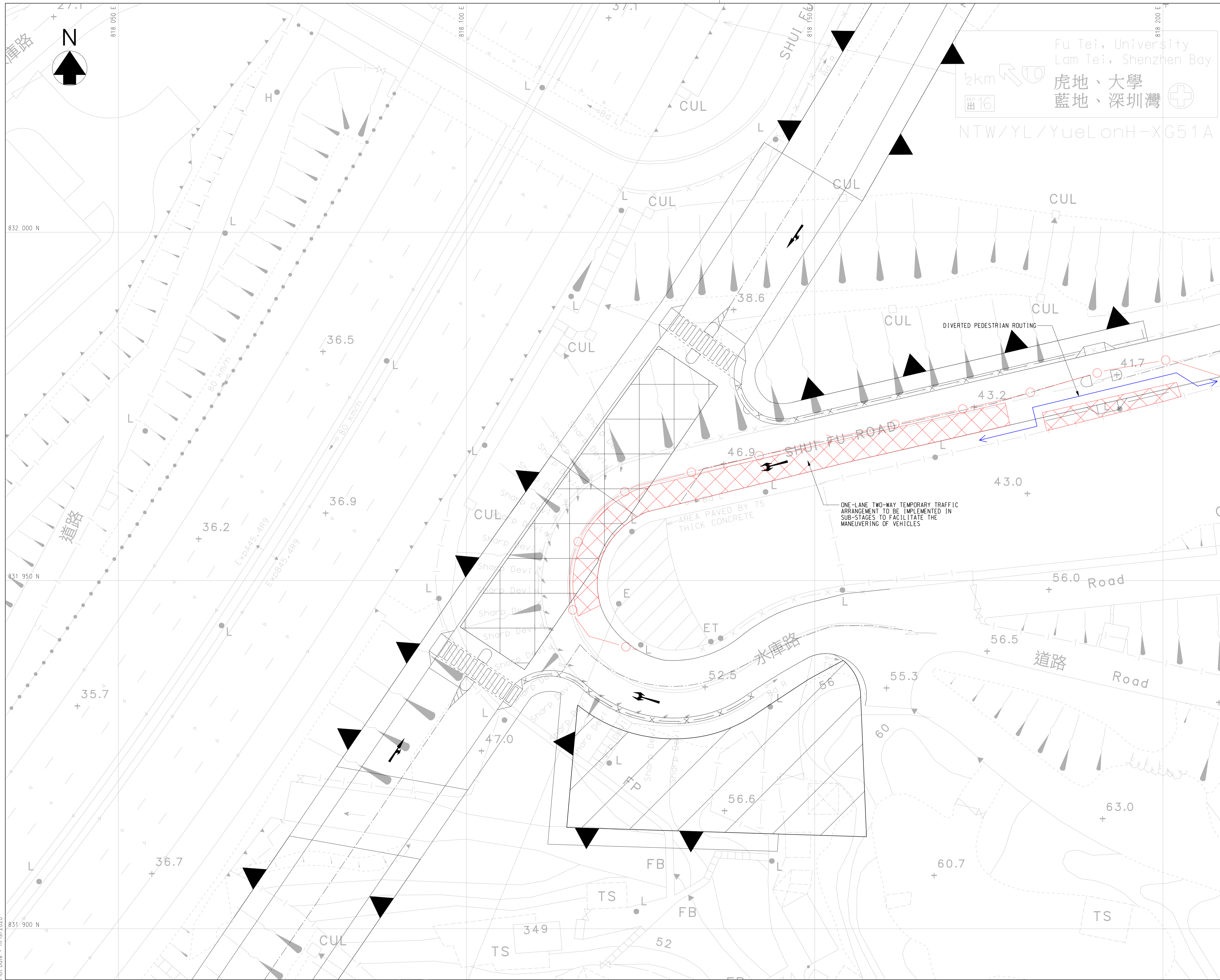

© Copyright by Black & Veatch Hong Kong Limited

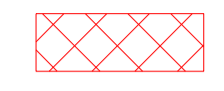
- LEGEND:**
-  TRAFFIC CONES WITH FLASHING LIGHTS
  -  WORKS AREA

Fu Tei, University  
Lam Tei, Shenzhen Bay  
虎地、大學  
藍地、深圳灣

NTW/YL/YueLonH-XG51A

Revision	Date	Description			Initial
		Designed	Checked	Drawn	Checked
Initial	KCC	SFL	SZ	SFL	
Date	11/20	11/20	11/20	11/20	11/20

Approved

Agreement no.  
CE 92/2017 (CE)

Agreement title  
SITE FORMATION AND INFRASTRUCTURE WORKS FOR PUBLIC HOUSING DEVELOPMENT NEAR TAN KWAI TSUEN, YUEN LONG - INVESTIGATION, DESIGN AND CONSTRUCTION

Figure title  
TEMPORARY TRAFFIC MANAGEMENT AT JUNCTION OF SHUI FU ROAD / PROPOSED ACCESS ROAD (J12) - STAGE 2

Figure no.	Scale
6.12	1 : 250 (A1) 1 : 500 (A3)

土木工程拓展署  
**CEDD Civil Engineering and Development Department**

  
BINNIES HONG KONG LIMITED  
賓尼士工程顧問有限公司

Plot Date - 11/19/2020

# **APPENDIX A**

## **Detailed Summary of Validation Results**

Appendix A - Detailed Summary of Validation Results  
Screenlines for Local Area Traffic Model Validation

**Screenline E-E NB**

Street Name	Dir'n	PV (pcu/hr)					GV (pcu/hr)					Total = PV+GV+PT (pcu/hr)				
		Obs.	Mod.	Diff.	%Diff.	GEH	Obs.	Mod.	Diff.	%Diff.	GEH	Obs.	Mod.	Diff.	%Diff.	GEH
Castle Peak Road - Lam Tei between Lan Tei	NB	765	820	55	7%	1.95	515	565	50	10%	2.15	1420	1525	105	7%	2.74
Yuen Long Highway between Kong Sham W	NB	2640	2585	-55	-2%	1.08	2285	2225	-60	-3%	1.26	5105	4990	-115	-2%	1.62
<b>Total</b>		<b>3405</b>	<b>3405</b>	<b>0</b>	<b>0%</b>	<b>0.00</b>	<b>2800</b>	<b>2790</b>	<b>-10</b>	<b>0%</b>	<b>0.19</b>	<b>6525</b>	<b>6515</b>	<b>-10</b>	<b>0%</b>	<b>0.12</b>

**Screenline E-E SB**

Street Name	Dir'n	PV (pcu/hr)					GV (pcu/hr)					Total = PV+GV+PT (pcu/hr)				
		Obs.	Mod.	Diff.	%Diff.	GEH	Obs.	Mod.	Diff.	%Diff.	GEH	Obs.	Mod.	Diff.	%Diff.	GEH
Castle Peak Road - Lam Tei between Lan Tei	SB	740	750	10	1%	0.37	510	505	-5	-1%	0.22	1420	1425	5	0%	0.13
Yuen Long Highway between Kong Sham W	SB	2695	2710	15	1%	0.29	1995	2000	5	0%	0.11	4865	4885	20	0%	0.29
<b>Total</b>		<b>3435</b>	<b>3460</b>	<b>25</b>	<b>1%</b>	<b>0.43</b>	<b>2505</b>	<b>2505</b>	<b>0</b>	<b>0%</b>	<b>0.00</b>	<b>6285</b>	<b>6310</b>	<b>25</b>	<b>0%</b>	<b>0.32</b>

**Screenline F-F NB**

Street Name	Dir'n	PV (pcu/hr)					GV (pcu/hr)					Total = PV+GV+PT (pcu/hr)				
		Obs.	Mod.	Diff.	%Diff.	GEH	Obs.	Mod.	Diff.	%Diff.	GEH	Obs.	Mod.	Diff.	%Diff.	GEH
Yuen Long Highway between Tin Shui Wai V	NB	2435	2525	90	4%	1.81	2170	2170	0	0%	0.00	4760	4850	90	2%	1.30
Castle Peak Road - Ping Shan	NB	445	445	0	0%	0.00	215	235	20	9%	1.33	830	850	20	2%	0.69
Hung Tin Road	NB	1435	1365	-70	-5%	1.87	900	800	-100	-11%	3.43	2390	2220	-170	-7%	3.54
<b>Total</b>		<b>4315</b>	<b>4335</b>	<b>20</b>	<b>0%</b>	<b>0.30</b>	<b>3285</b>	<b>3205</b>	<b>-80</b>	<b>-2%</b>	<b>1.40</b>	<b>7980</b>	<b>7920</b>	<b>-60</b>	<b>-1%</b>	<b>0.67</b>

**Screenline F-F SB**

Street Name	Dir'n	PV (pcu/hr)					GV (pcu/hr)					Total = PV+GV+PT (pcu/hr)				
		Obs.	Mod.	Diff.	%Diff.	GEH	Obs.	Mod.	Diff.	%Diff.	GEH	Obs.	Mod.	Diff.	%Diff.	GEH
Yuen Long Highway between Tin Shui Wai V	SB	2580	2590	10	0%	0.20	1860	1870	10	1%	0.23	4570	4590	20	0%	0.30
Castle Peak Road - Ping Shan	SB	505	510	5	1%	0.22	385	415	30	8%	1.50	1055	1090	35	3%	1.07
Hung Tin Road	SB	1630	1620	-10	-1%	0.25	915	940	25	3%	0.82	2610	2625	15	1%	0.29
<b>Total</b>		<b>4715</b>	<b>4720</b>	<b>5</b>	<b>0%</b>	<b>0.07</b>	<b>3160</b>	<b>3225</b>	<b>65</b>	<b>2%</b>	<b>1.15</b>	<b>8235</b>	<b>8305</b>	<b>70</b>	<b>1%</b>	<b>0.77</b>

Appendix A - Detailed Summary of Validation Results  
 Screenlines for Local Area Traffic Model Validation

**Screenline E-E NB**

Street Name	Dir'n	PV (pcu/hr)					GV (pcu/hr)					Total = PV+GV+PT (pcu/hr)				
		Obs.	Mod.	Diff.	%Diff.	GEH	Obs.	Mod.	Diff.	%Diff.	GEH	Obs.	Mod.	Diff.	%Diff.	GEH
Castle Peak Road - Lam Tei between Lan Tei	NB	810	820	10	1%	0.35	730	765	35	5%	1.28	1745	1790	45	3%	1.07
Yuen Long Highway between Kong Sham W	NB	2595	2780	185	7%	3.57	2365	2325	-40	-2%	0.83	5140	5285	145	3%	2.01
<b>Total</b>		<b>3405</b>	<b>3600</b>	<b>195</b>	<b>6%</b>	<b>3.29</b>	<b>3095</b>	<b>3090</b>	<b>-5</b>	<b>0%</b>	<b>0.09</b>	<b>6885</b>	<b>7075</b>	<b>190</b>	<b>3%</b>	<b>2.27</b>

**Screenline E-E SB**

Street Name	Dir'n	PV (pcu/hr)					GV (pcu/hr)					Total = PV+GV+PT (pcu/hr)				
		Obs.	Mod.	Diff.	%Diff.	GEH	Obs.	Mod.	Diff.	%Diff.	GEH	Obs.	Mod.	Diff.	%Diff.	GEH
Castle Peak Road - Lam Tei between Lan Tei	SB	800	815	15	2%	0.53	455	440	-15	-3%	0.71	1400	1400	0	0%	0.00
Yuen Long Highway between Kong Sham W	SB	2610	2475	-135	-5%	2.68	1895	1860	-35	-2%	0.81	4670	4500	-170	-4%	2.51
<b>Total</b>		<b>3410</b>	<b>3290</b>	<b>-120</b>	<b>-4%</b>	<b>2.07</b>	<b>2350</b>	<b>2300</b>	<b>-50</b>	<b>-2%</b>	<b>1.04</b>	<b>6070</b>	<b>5900</b>	<b>-170</b>	<b>-3%</b>	<b>2.20</b>

**Screenline F-F NB**

Street Name	Dir'n	PV (pcu/hr)					GV (pcu/hr)					Total = PV+GV+PT (pcu/hr)				
		Obs.	Mod.	Diff.	%Diff.	GEH	Obs.	Mod.	Diff.	%Diff.	GEH	Obs.	Mod.	Diff.	%Diff.	GEH
Yuen Long Highway between Tin Shui Wai V	NB	2390	2305	-85	-4%	1.75	2000	1950	-50	-3%	1.13	4520	4385	-135	-3%	2.02
Castle Peak Road - Ping Shan	NB	500	550	50	10%	2.18	315	355	40	13%	2.19	1015	1105	90	9%	2.76
Hung Tin Road	NB	1185	1195	10	1%	0.29	1100	1070	-30	-3%	0.91	2355	2335	-20	-1%	0.41
<b>Total</b>		<b>4075</b>	<b>4050</b>	<b>-25</b>	<b>-1%</b>	<b>0.39</b>	<b>3415</b>	<b>3375</b>	<b>-40</b>	<b>-1%</b>	<b>0.69</b>	<b>7890</b>	<b>7825</b>	<b>-65</b>	<b>-1%</b>	<b>0.73</b>

**Screenline F-F SB**

Street Name	Dir'n	PV (pcu/hr)					GV (pcu/hr)					Total = PV+GV+PT (pcu/hr)				
		Obs.	Mod.	Diff.	%Diff.	GEH	Obs.	Mod.	Diff.	%Diff.	GEH	Obs.	Mod.	Diff.	%Diff.	GEH
Yuen Long Highway between Tin Shui Wai V	SB	2365	2240	-125	-5%	2.61	1750	1690	-60	-3%	1.45	4245	4060	-185	-4%	2.87
Castle Peak Road - Ping Shan	SB	515	550	35	7%	1.52	260	275	15	6%	0.92	960	1010	50	5%	1.59
Hung Tin Road	SB	980	835	-145	-15%	4.81	660	650	-10	-2%	0.39	1685	1530	-155	-9%	3.87
<b>Total</b>		<b>3860</b>	<b>3625</b>	<b>-235</b>	<b>-6%</b>	<b>3.84</b>	<b>2670</b>	<b>2615</b>	<b>-55</b>	<b>-2%</b>	<b>1.07</b>	<b>6890</b>	<b>6600</b>	<b>-290</b>	<b>-4%</b>	<b>3.53</b>

Appendix A - Detailed Summary of Validation Results  
Key Junctions for Local Area Traffic Model Validation (AM Peak)

J1 - Hung Chi Road/ Hung Tin Road														
	Street Name	Dir'n	PV (pcu/hr)				GV (pcu/hr)				Total = PV+GV+PT (pcu/hr)			
			Obs.	Mod.	Diff.	GEH	Obs.	Mod.	Diff.	GEH	Obs.	Mod.	Diff.	GEH
Entry Arm	Hung Chi Road - WB	IB	20	20	0	0.00	80	80	0	0.00	100	100	0	0.00
	Hung Tin Road - SB	IB	660	560	-100	4.05	590	515	-75	3.19	1335	1160	-175	4.95
	Hung Chi Road - EB	IB	165	135	-30	2.45	55	55	0	0.00	240	210	-30	2.00
	Shek Po East Road	IB	65	30	-35	5.08	95	30	-65	8.22	160	60	-100	9.53
	Hung Tin Road - NB	IB	430	450	20	0.95	155	135	-20	1.66	615	615	0	0.00
	<b>Total</b>	<b>IB</b>	<b>1340</b>	<b>1195</b>	<b>-145</b>	<b>4.07</b>	<b>975</b>	<b>815</b>	<b>-160</b>	<b>5.35</b>	<b>2450</b>	<b>2145</b>	<b>-305</b>	<b>6.36</b>
Exit Arm	Hung Chi Road - WB	OB	65	120	55	5.72	55	55	0	0.00	120	175	55	4.53
	Hung Tin Road - SB	OB	755	750	-5	0.18	585	530	-55	2.33	1385	1325	-60	1.63
	Hung Chi Road - EB	OB	255	265	10	0.62	160	175	15	1.16	455	480	25	1.16
	Shek Po East Road	OB	45	25	-20	3.38	35	30	-5	0.88	80	55	-25	3.04
	Hung Tin Road - NB	OB	270	195	-75	4.92	165	100	-65	5.65	465	325	-140	7.04
	<b>Total</b>	<b>OB</b>	<b>1390</b>	<b>1355</b>	<b>-35</b>	<b>0.94</b>	<b>1000</b>	<b>890</b>	<b>-110</b>	<b>3.58</b>	<b>2505</b>	<b>2360</b>	<b>-145</b>	<b>2.94</b>

J2 - Castle Peak Road (Hung Shui Kiu)/ Hung Tak Road														
	Street Name	Dir'n	PV (pcu/hr)				GV (pcu/hr)				Total = PV+GV+PT (pcu/hr)			
			Obs.	Mod.	Diff.	GEH	Obs.	Mod.	Diff.	GEH	Obs.	Mod.	Diff.	GEH
Entry Arm	Castle Peak Road (Hung Shui Kiu) - SB	IB	620	620	0	0.00	305	305	0	0.00	1095	1095	0	0.00
	Hung Tak Road	IB	320	325	5	0.28	90	90	0	0.00	420	425	5	0.24
	Castle Peak Road (Hung Shui Kiu) - NB	IB	265	275	10	0.61	215	235	20	1.33	655	685	30	1.16
	<b>Total</b>	<b>IB</b>	<b>1205</b>	<b>1220</b>	<b>15</b>	<b>0.43</b>	<b>610</b>	<b>630</b>	<b>20</b>	<b>0.80</b>	<b>2170</b>	<b>2205</b>	<b>35</b>	<b>0.75</b>
Exit Arm	Castle Peak Road (Hung Shui Kiu) - SB	OB	570	585	15	0.62	295	315	20	1.15	1050	1085	35	1.07
	Hung Tak Road	OB	245	245	0	0.00	55	55	0	0.00	310	310	0	0.00
	Castle Peak Road (Hung Shui Kiu) - NB	OB	390	390	0	0.00	260	260	0	0.00	810	810	0	0.00
	<b>Total</b>	<b>OB</b>	<b>1205</b>	<b>1220</b>	<b>15</b>	<b>0.43</b>	<b>610</b>	<b>630</b>	<b>20</b>	<b>0.80</b>	<b>2170</b>	<b>2205</b>	<b>35</b>	<b>0.75</b>

J3 - Castle Peak Road (Hung Shui Kiu)/ Tan Kwai Tsuen Road														
	Street Name	Dir'n	PV (pcu/hr)				GV (pcu/hr)				Total = PV+GV+PT (pcu/hr)			
			Obs.	Mod.	Diff.	GEH	Obs.	Mod.	Diff.	GEH	Obs.	Mod.	Diff.	GEH
Entry Arm	Castle Peak Road (Hung Shui Kiu) - SB	IB	390	390	0	0.00	255	255	0	0.00	805	805	0	0.00
	Tan Kwai Tsuen Road	IB	175	140	-35	2.79	50	50	0	0.00	225	190	-35	2.43
	Castle Peak Road (Hung Shui Kiu) - NB	IB	430	445	15	0.72	280	300	20	1.17	885	920	35	1.17
	<b>Total</b>	<b>IB</b>	<b>995</b>	<b>975</b>	<b>-20</b>	<b>0.64</b>	<b>585</b>	<b>605</b>	<b>20</b>	<b>0.82</b>	<b>1915</b>	<b>1915</b>	<b>0</b>	<b>0.00</b>
Exit Arm	Castle Peak Road (Hung Shui Kiu) - SB	OB	265	275	10	0.61	215	235	20	1.33	655	685	30	1.16
	Tan Kwai Tsuen Road	OB	165	170	5	0.39	65	65	0	0.00	230	235	5	0.33
	Castle Peak Road (Hung Shui Kiu) - NB	OB	565	530	-35	1.50	305	305	0	0.00	1030	995	-35	1.10
	<b>Total</b>	<b>OB</b>	<b>995</b>	<b>975</b>	<b>-20</b>	<b>0.64</b>	<b>585</b>	<b>605</b>	<b>20</b>	<b>0.82</b>	<b>1915</b>	<b>1915</b>	<b>0</b>	<b>0.00</b>

J4 - Tan Kwai Tsuen Road/ Hung Shun Road														
	Street Name	Dir'n	PV (pcu/hr)				GV (pcu/hr)				Total = PV+GV+PT (pcu/hr)			
			Obs.	Mod.	Diff.	GEH	Obs.	Mod.	Diff.	GEH	Obs.	Mod.	Diff.	GEH
Entry Arm	Tan Kwai Tsuen Road - SB	IB	165	170	5	0.39	60	60	0	0.00	225	230	5	0.33
	Hung Shun Road	IB	175	175	0	0.00	30	30	0	0.00	205	205	0	0.00
	Tan Kwai Tsuen Road - NB	IB	275	240	-35	2.18	60	60	0	0.00	335	300	-35	1.96
	<b>Total</b>	<b>IB</b>	<b>615</b>	<b>585</b>	<b>-30</b>	<b>1.22</b>	<b>150</b>	<b>150</b>	<b>0</b>	<b>0.00</b>	<b>765</b>	<b>735</b>	<b>-30</b>	<b>1.10</b>
Exit Arm	Tan Kwai Tsuen Road - SB	OB	175	140	-35	2.79	45	45	0	0.00	220	185	-35	2.46
	Hung Shun Road	OB	260	260	0	0.00	70	70	0	0.00	330	330	0	0.00
	Tan Kwai Tsuen Road - NB	OB	180	185	5	0.37	35	35	0	0.00	215	220	5	0.34
	<b>Total</b>	<b>OB</b>	<b>615</b>	<b>585</b>	<b>-30</b>	<b>1.22</b>	<b>150</b>	<b>150</b>	<b>0</b>	<b>0.00</b>	<b>765</b>	<b>735</b>	<b>-30</b>	<b>1.10</b>

J5 - Shun Tat Street/ Castle Peak Road (Lam Tei)/ Castle Peak Road (Hung Shui Kiu)														
	Street Name	Dir'n	PV (pcu/hr)				GV (pcu/hr)				Total = PV+GV+PT (pcu/hr)			
			Obs.	Mod.	Diff.	GEH	Obs.	Mod.	Diff.	GEH	Obs.	Mod.	Diff.	GEH
Entry Arm	Castle Peak Road (Hung Shui Kiu)	IB	540	545	5	0.21	405	410	5	0.25	1090	1100	10	0.30
	Shun Tat Street	IB	125	125	0	0.00	95	95	0	0.00	220	220	0	0.00
	Castle Peak Road (Lam Tei)	IB	605	715	110	4.28	515	580	65	2.78	1240	1415	175	4.80
	Access Road to Yick Yuen	IB	5	5	0	0.00	0	0	0	0.00	5	5	0	0.00
	<b>Total</b>	<b>IB</b>	<b>1275</b>	<b>1390</b>	<b>115</b>	<b>3.15</b>	<b>1015</b>	<b>1085</b>	<b>70</b>	<b>2.16</b>	<b>2555</b>	<b>2740</b>	<b>185</b>	<b>3.60</b>
Exit Arm	Castle Peak Road (Hung Shui Kiu)	OB	545	640	95	3.90	455	545	90	4.02	1120	1305	185	5.31
	Shun Tat Street	OB	95	100	5	0.51	135	110	-25	2.26	230	210	-20	1.35
	Castle Peak Road (Lam Tei)	OB	635	640	5	0.20	425	430	5	0.24	1205	1215	10	0.29
	Access Road to Yick Yuen	OB	0	10	10	4.47	0	0	0	0.00	0	10	10	4.47
	<b>Total</b>	<b>OB</b>	<b>1275</b>	<b>1390</b>	<b>115</b>	<b>3.15</b>	<b>1015</b>	<b>1085</b>	<b>70</b>	<b>2.16</b>	<b>2555</b>	<b>2740</b>	<b>185</b>	<b>3.60</b>

J6 - Shun Tat Street / Tat Fuk Road														
	Street Name	Dir'n	PV (pcu/hr)				GV (pcu/hr)				Total = PV+GV+PT (pcu/hr)			
			Obs.	Mod.	Diff.	GEH	Obs.	Mod.	Diff.	GEH	Obs.	Mod.	Diff.	GEH
Entry Arm	Shun Tat Street - WB	IB	0	0	0	0.00	90	75	-15	1.65	90	75	-15	1.65
	Tat Fuk Road - NB	IB	0	0	0	0.00	5	0	-5	3.16	5	0	-5	3.16
	Shun Tat Street - EB	IB	25	10	-15	3.59	100	85	-15	1.56	125	95	-30	2.86
	Tat Fuk Road - SB	IB	0	0	0	0.00	0	0	0	0.00	0	0	0	0.00
	<b>Total</b>	<b>IB</b>	<b>25</b>	<b>10</b>	<b>-15</b>	<b>3.59</b>	<b>195</b>	<b>160</b>	<b>-35</b>	<b>2.63</b>	<b>220</b>	<b>170</b>	<b>-50</b>	<b>3.58</b>
Exit Arm	Shun Tat Street - WB	OB	10	10	0	0.00	95	85	-10	1.05	105	95	-10	1.00
	Tat Fuk Road - NB	OB	10	0	-10	4.47	5	0	-5	3.16	15	0	-15	5.48
	Shun Tat Street - EB	OB	0	0	0	0.00	95	75	-20	2.17	95	75	-20	2.17
	Tat Fuk Road - SB	OB	5	0	-5	3.16	0	0	0	0.00	5	0	-5	3.16
	<b>Total</b>	<b>OB</b>	<b>25</b>	<b>10</b>	<b>-15</b>	<b>3.59</b>	<b>195</b>	<b>160</b>	<b>-35</b>	<b>2.63</b>	<b>220</b>	<b>170</b>	<b>-50</b>	<b>3.58</b>

J7 - Shun Tat Street/ Tung Fuk Road/ Access Road to North West N.T. Refuse Transfer Station														
	Street Name	Dir'n	PV (pcu/hr)				GV (pcu/hr)				Total = PV+GV+PT (pcu/hr)			
			Obs.	Mod.	Diff.	GEH	Obs.	Mod.	Diff.	GEH	Obs.	Mod.	Diff.	GEH
Entry Arm	Shun Tat Street - WB	IB	0	0	0	0.00	0	0	0	0.00	0	0	0	0.00
	Tung Fuk Road	IB	0	0	0	0.00	0	0	0	0.00	0	0	0	0.00
	Shun Tat Street - EB	IB	10	10	0	0.00	95	85	-10	1.05	105	95	-10	1.00
	Access Road to North West N.T. Refuse Transfer S	IB	0	0	0	0.00	90	70	-20	2.24	90	70	-20	2.24
	<b>Total</b>	<b>IB</b>	<b>10</b>	<b>10</b>	<b>0</b>	<b>0.00</b>	<b>185</b>	<b>155</b>	<b>-30</b>	<b>2.30</b>	<b>195</b>	<b>165</b>	<b>-30</b>	<b>2.24</b>
Exit Arm	Shun Tat Street - WB	OB	0	0	0	0.00	0	0	0	0.00	0	0	0	0.00
	Tung Fuk Road	OB	10	10	0	0.00	10	5	-5	1.83	20	15	-5	1.20
	Shun Tat Street - EB	OB	0	0	0	0.00	85	70	-15	1.70	85	70	-15	1.70
	Access Road to North West N.T. Refuse Transfer S	OB	0	0	0	0.00	90	80	-10	1.08	90	80	-10	1.08
	<b>Total</b>	<b>OB</b>	<b>10</b>	<b>10</b>	<b>0</b>	<b>0.00</b>	<b>185</b>	<b>155</b>	<b>-30</b>	<b>2.30</b>	<b>195</b>	<b>165</b>	<b>-30</b>	<b>2.24</b>

**J8 - Castle Peak Road (Lam Tei)/ Fuk Hang Tsuen Road**

	Street Name	Dir'n	PV (pcu/hr)				GV (pcu/hr)				Total = PV+GV+PT (pcu/hr)			
			Obs.	Mod.	Diff.	GEH	Obs.	Mod.	Diff.	GEH	Obs.	Mod.	Diff.	GEH
Entry Arm	Castle Peak Road (Lam Tei) - SB	IB	630	640	10	0.40	425	430	5	0.24	1205	1220	15	0.43
	Fuk Hang Tsuen Road	IB	230	175	-55	3.87	170	150	-20	1.58	420	345	-75	3.83
	Castle Peak Road (Lam Tei) - NB	IB	765	820	55	1.95	515	565	50	2.15	1420	1525	105	2.74
	<b>Total</b>	<b>IB</b>	<b>1625</b>	<b>1635</b>	<b>10</b>	<b>0.25</b>	<b>1110</b>	<b>1145</b>	<b>35</b>	<b>1.04</b>	<b>3045</b>	<b>3090</b>	<b>45</b>	<b>0.81</b>
Exit Arm	Castle Peak Road (Lam Tei) - SB	OB	690	710	20	0.76	495	585	90	3.87	1305	1415	110	2.98
	Fuk Hang Tsuen Road	OB	195	175	-20	1.47	105	55	-50	5.59	320	250	-70	4.15
	Castle Peak Road (Lam Tei) - NB	OB	740	750	10	0.37	510	505	-5	0.22	1420	1425	5	0.13
	<b>Total</b>	<b>OB</b>	<b>1625</b>	<b>1635</b>	<b>10</b>	<b>0.25</b>	<b>1110</b>	<b>1145</b>	<b>35</b>	<b>1.04</b>	<b>3045</b>	<b>3090</b>	<b>45</b>	<b>0.81</b>

**J9 - Hung Tin Road/ Castle Peak Road (Hung Shui Kiu)**

	Street Name	Dir'n	PV (pcu/hr)				GV (pcu/hr)				Total = PV+GV+PT (pcu/hr)			
			Obs.	Mod.	Diff.	GEH	Obs.	Mod.	Diff.	GEH	Obs.	Mod.	Diff.	GEH
Entry Arm	Castle Peak Road (Hung Shui Kiu) - NB	IB	545	455	-90	4.02	330	285	-45	2.57	1060	925	-135	4.29
	Hung Tin Road	IB	385	360	-25	1.30	200	155	-45	3.38	625	555	-70	2.88
	Castle Peak Road (Hung Shui Kiu) - SB	IB	505	510	5	0.22	385	415	30	1.50	1055	1090	35	1.07
	<b>Total</b>	<b>IB</b>	<b>1435</b>	<b>1325</b>	<b>-110</b>	<b>2.96</b>	<b>915</b>	<b>855</b>	<b>-60</b>	<b>2.02</b>	<b>2740</b>	<b>2570</b>	<b>-170</b>	<b>3.30</b>
Exit Arm	Castle Peak Road (Hung Shui Kiu) - NB	OB	620	620	0	0.00	350	300	-50	2.77	1145	1095	-50	1.49
	Hung Tin Road	OB	370	260	-110	6.20	350	320	-30	1.64	765	625	-140	5.31
	Castle Peak Road (Hung Shui Kiu) - SB	OB	445	445	0	0.00	215	235	20	1.33	830	850	20	0.69
	<b>Total</b>	<b>OB</b>	<b>1435</b>	<b>1325</b>	<b>-110</b>	<b>2.96</b>	<b>915</b>	<b>855</b>	<b>-60</b>	<b>2.02</b>	<b>2740</b>	<b>2570</b>	<b>-170</b>	<b>3.30</b>

**J11 - Yuen Long Highway/ Hung Tin Road**

	Street Name	Dir'n	PV (pcu/hr)				GV (pcu/hr)				Total = PV+GV+PT (pcu/hr)			
			Obs.	Mod.	Diff.	GEH	Obs.	Mod.	Diff.	GEH	Obs.	Mod.	Diff.	GEH
Entry Arm	Yuen Long Highway - NB	IB	2435	2400	-35	0.71	2035	1980	-55	1.23	4655	4565	-90	1.33
	Hung Tin Road	IB	1575	1560	-15	0.38	1175	1180	5	0.15	2785	2775	-10	0.19
	Yuen Long Highway - SB	IB	2580	2590	10	0.20	1860	1870	10	0.23	4570	4590	20	0.30
	<b>Total</b>	<b>IB</b>	<b>6590</b>	<b>6550</b>	<b>-40</b>	<b>0.49</b>	<b>5070</b>	<b>5030</b>	<b>-40</b>	<b>0.56</b>	<b>12010</b>	<b>11930</b>	<b>-80</b>	<b>0.73</b>
Exit Arm	Yuen Long Highway - NB	OB	2615	2625	10	0.20	1960	1965	5	0.11	4740	4755	15	0.22
	Hung Tin Road	OB	1540	1400	-140	3.65	940	895	-45	1.49	2510	2325	-185	3.76
	Yuen Long Highway - SB	OB	2435	2525	90	1.81	2170	2170	0	0.00	4760	4850	90	1.30
	<b>Total</b>	<b>OB</b>	<b>6590</b>	<b>6550</b>	<b>-40</b>	<b>0.49</b>	<b>5070</b>	<b>5030</b>	<b>-40</b>	<b>0.56</b>	<b>12010</b>	<b>11930</b>	<b>-80</b>	<b>0.73</b>

**J12 - Yuen Long Highway/ Kong Sham Western Highway**

	Street Name	Dir'n	PV (pcu/hr)				GV (pcu/hr)				Total = PV+GV+PT (pcu/hr)			
			Obs.	Mod.	Diff.	GEH	Obs.	Mod.	Diff.	GEH	Obs.	Mod.	Diff.	GEH
Entry Arm	Yuen Long Highway - NB	IB	2640	2585	-55	1.08	2285	2225	-60	1.26	5105	4990	-115	1.62
	Kong Sham Western Highway	IB	320	315	-5	0.28	350	355	5	0.27	735	735	0	0.00
	Yuen Long Highway - SB	IB	2615	2625	10	0.20	1960	1965	5	0.11	4740	4755	15	0.22
	<b>Total</b>	<b>IB</b>	<b>5575</b>	<b>5525</b>	<b>-50</b>	<b>0.67</b>	<b>4595</b>	<b>4545</b>	<b>-50</b>	<b>0.74</b>	<b>10580</b>	<b>10480</b>	<b>-100</b>	<b>0.97</b>
Exit Arm	Yuen Long Highway - NB	OB	2695	2710	15	0.29	1995	2000	5	0.11	4865	4885	20	0.29
	Kong Sham Western Highway	OB	440	385	-55	2.71	570	555	-15	0.63	1075	1005	-70	2.17
	Yuen Long Highway - SB	OB	2435	2400	-35	0.71	2035	1980	-55	1.23	4655	4565	-90	1.33
	<b>Total</b>	<b>OB</b>	<b>5570</b>	<b>5495</b>	<b>-75</b>	<b>1.01</b>	<b>4600</b>	<b>4535</b>	<b>-65</b>	<b>0.96</b>	<b>10595</b>	<b>10455</b>	<b>-140</b>	<b>1.36</b>

Appendix A - Detailed Summary of Validation Results  
Key Junctions for Local Area Traffic Model Validation (PM Peak)

J1 - Hung Chi Road/ Hung Tin Road														
	Street Name	Dir'n	PV (pcu/hr)				GV (pcu/hr)				Total = PV+GV+PT (pcu/hr)			
			Obs.	Mod.	Diff.	GEH	Obs.	Mod.	Diff.	GEH	Obs.	Mod.	Diff.	GEH
Entry Arm	Hung Chi Road - WB	IB	55	55	0	0.00	95	95	0	0.00	150	150	0	0.00
	Hung Tin Road - SB	IB	735	600	-135	5.23	750	690	-60	2.24	1570	1375	-195	5.08
	Hung Chi Road - EB	IB	115	95	-20	1.95	95	90	-5	0.52	215	190	-25	1.76
	Shek Po East Road	IB	45	15	-30	5.48	70	25	-45	6.53	115	40	-75	8.52
	Hung Tin Road - NB	IB	255	255	0	0.00	170	150	-20	1.58	440	420	-20	0.96
	<b>Total</b>	<b>IB</b>	<b>1205</b>	<b>1020</b>	<b>-185</b>	<b>5.55</b>	<b>1180</b>	<b>1050</b>	<b>-130</b>	<b>3.89</b>	<b>2490</b>	<b>2175</b>	<b>-315</b>	<b>6.52</b>
Exit Arm	Hung Chi Road - WB	OB	35	40	5	0.82	115	115	0	0.00	150	155	5	0.40
	Hung Tin Road - SB	OB	625	605	-20	0.81	560	540	-20	0.85	1220	1180	-40	1.15
	Hung Chi Road - EB	OB	275	215	-60	3.83	225	200	-25	1.71	525	440	-85	3.87
	Shek Po East Road	OB	70	50	-20	2.58	135	105	-30	2.74	205	155	-50	3.73
	Hung Tin Road - NB	OB	275	190	-85	5.57	170	130	-40	3.27	485	360	-125	6.08
	<b>Total</b>	<b>OB</b>	<b>1280</b>	<b>1100</b>	<b>-180</b>	<b>5.22</b>	<b>1205</b>	<b>1090</b>	<b>-115</b>	<b>3.39</b>	<b>2585</b>	<b>2290</b>	<b>-295</b>	<b>5.98</b>

J2 - Castle Peak Road (Hung Shui Kiu)/ Hung Tak Road														
	Street Name	Dir'n	PV (pcu/hr)				GV (pcu/hr)				Total = PV+GV+PT (pcu/hr)			
			Obs.	Mod.	Diff.	GEH	Obs.	Mod.	Diff.	GEH	Obs.	Mod.	Diff.	GEH
Entry Arm	Castle Peak Road (Hung Shui Kiu) - SB	IB	500	495	-5	0.22	265	265	0	0.00	930	925	-5	0.16
	Hung Tak Road	IB	205	205	0	0.00	60	60	0	0.00	275	275	0	0.00
	Castle Peak Road (Hung Shui Kiu) - NB	IB	390	445	55	2.69	190	260	70	4.67	800	925	125	4.26
	<b>Total</b>	<b>IB</b>	<b>1095</b>	<b>1145</b>	<b>50</b>	<b>1.49</b>	<b>515</b>	<b>585</b>	<b>70</b>	<b>2.98</b>	<b>2005</b>	<b>2125</b>	<b>120</b>	<b>2.64</b>
Exit Arm	Castle Peak Road (Hung Shui Kiu) - SB	OB	580	635	55	2.23	245	315	70	4.18	1055	1180	125	3.74
	Hung Tak Road	OB	160	190	30	2.27	80	75	-5	0.57	250	275	25	1.54
	Castle Peak Road (Hung Shui Kiu) - NB	OB	355	320	-35	1.91	190	195	5	0.36	700	670	-30	1.15
	<b>Total</b>	<b>OB</b>	<b>1095</b>	<b>1145</b>	<b>50</b>	<b>1.49</b>	<b>515</b>	<b>585</b>	<b>70</b>	<b>2.98</b>	<b>2005</b>	<b>2125</b>	<b>120</b>	<b>2.64</b>

J3 - Castle Peak Road (Hung Shui Kiu)/ Tan Kwai Tsuen Road														
	Street Name	Dir'n	PV (pcu/hr)				GV (pcu/hr)				Total = PV+GV+PT (pcu/hr)			
			Obs.	Mod.	Diff.	GEH	Obs.	Mod.	Diff.	GEH	Obs.	Mod.	Diff.	GEH
Entry Arm	Castle Peak Road (Hung Shui Kiu) - SB	IB	355	320	-35	1.91	190	195	5	0.36	705	675	-30	1.14
	Tan Kwai Tsuen Road	IB	145	145	0	0.00	70	40	-30	4.05	215	185	-30	2.12
	Castle Peak Road (Hung Shui Kiu) - NB	IB	515	530	15	0.66	235	300	65	3.97	970	1050	80	2.52
	<b>Total</b>	<b>IB</b>	<b>1015</b>	<b>995</b>	<b>-20</b>	<b>0.63</b>	<b>495</b>	<b>535</b>	<b>40</b>	<b>1.76</b>	<b>1890</b>	<b>1910</b>	<b>20</b>	<b>0.46</b>
Exit Arm	Castle Peak Road (Hung Shui Kiu) - SB	OB	390	445	55	2.69	190	260	70	4.67	800	925	125	4.26
	Tan Kwai Tsuen Road	OB	125	85	-40	3.90	45	40	-5	0.77	170	125	-45	3.71
	Castle Peak Road (Hung Shui Kiu) - NB	OB	500	465	-35	1.59	260	235	-25	1.59	920	860	-60	2.01
	<b>Total</b>	<b>OB</b>	<b>1015</b>	<b>995</b>	<b>-20</b>	<b>0.63</b>	<b>495</b>	<b>535</b>	<b>40</b>	<b>1.76</b>	<b>1890</b>	<b>1910</b>	<b>20</b>	<b>0.46</b>

J4 - Tan Kwai Tsuen Road/ Hung Shun Road														
	Street Name	Dir'n	PV (pcu/hr)				GV (pcu/hr)				Total = PV+GV+PT (pcu/hr)			
			Obs.	Mod.	Diff.	GEH	Obs.	Mod.	Diff.	GEH	Obs.	Mod.	Diff.	GEH
Entry Arm	Tan Kwai Tsuen Road - SB	IB	120	85	-35	3.46	95	40	-55	6.69	215	125	-90	6.90
	Hung Shun Road	IB	155	190	35	2.66	75	65	-10	1.20	230	255	25	1.61
	Tan Kwai Tsuen Road - NB	IB	180	175	-5	0.38	45	45	0	0.00	225	220	-5	0.34
	<b>Total</b>	<b>IB</b>	<b>455</b>	<b>450</b>	<b>-5</b>	<b>0.24</b>	<b>215</b>	<b>150</b>	<b>-65</b>	<b>4.81</b>	<b>670</b>	<b>600</b>	<b>-70</b>	<b>2.78</b>
Exit Arm	Tan Kwai Tsuen Road - SB	OB	150	145	-5	0.41	40	40	0	0.00	190	185	-5	0.37
	Hung Shun Road	OB	145	145	0	0.00	70	45	-25	3.30	215	190	-25	1.76
	Tan Kwai Tsuen Road - NB	OB	160	160	0	0.00	105	65	-40	4.34	265	225	-40	2.56
	<b>Total</b>	<b>OB</b>	<b>455</b>	<b>450</b>	<b>-5</b>	<b>0.24</b>	<b>215</b>	<b>150</b>	<b>-65</b>	<b>4.81</b>	<b>670</b>	<b>600</b>	<b>-70</b>	<b>2.78</b>

J5 - Shun Tat Street/ Castle Peak Road (Lam Tei)/ Castle Peak Road (Hung Shui Kiu)														
	Street Name	Dir'n	PV (pcu/hr)				GV (pcu/hr)				Total = PV+GV+PT (pcu/hr)			
			Obs.	Mod.	Diff.	GEH	Obs.	Mod.	Diff.	GEH	Obs.	Mod.	Diff.	GEH
Entry Arm	Castle Peak Road (Hung Shui Kiu)	IB	560	655	95	3.85	410	385	-25	1.25	1095	1165	70	2.08
	Shun Tat Street	IB	90	90	0	0.00	70	100	30	3.25	160	190	30	2.27
	Castle Peak Road (Lam Tei)	IB	625	710	85	3.29	650	750	100	3.78	1460	1645	185	4.70
	Access Road to Yick Yuen	IB	10	20	10	2.58	0	0	0	0.00	10	20	10	2.58
	<b>Total</b>	<b>IB</b>	<b>1285</b>	<b>1475</b>	<b>190</b>	<b>5.11</b>	<b>1130</b>	<b>1235</b>	<b>105</b>	<b>3.05</b>	<b>2725</b>	<b>3020</b>	<b>295</b>	<b>5.50</b>
Exit Arm	Castle Peak Road (Hung Shui Kiu)	OB	570	665	95	3.82	570	660	90	3.63	1325	1510	185	4.91
	Shun Tat Street	OB	100	100	0	0.00	170	150	-20	1.58	270	250	-20	1.24
	Castle Peak Road (Lam Tei)	OB	610	705	95	3.70	390	415	25	1.25	1125	1245	120	3.49
	Access Road to Yick Yuen	OB	5	5	0	0.00	0	10	10	4.47	5	15	10	3.16
	<b>Total</b>	<b>OB</b>	<b>1285</b>	<b>1475</b>	<b>190</b>	<b>5.11</b>	<b>1130</b>	<b>1235</b>	<b>105</b>	<b>3.05</b>	<b>2725</b>	<b>3020</b>	<b>295</b>	<b>5.50</b>

J6 - Shun Tat Street / Tat Fuk Road														
	Street Name	Dir'n	PV (pcu/hr)				GV (pcu/hr)				Total = PV+GV+PT (pcu/hr)			
			Obs.	Mod.	Diff.	GEH	Obs.	Mod.	Diff.	GEH	Obs.	Mod.	Diff.	GEH
Entry Arm	Shun Tat Street - WB	IB	5	5	0	0.00	60	60	0	0.00	65	65	0	0.00
	Tat Fuk Road - NB	IB	10	0	-10	4.47	5	0	-5	3.16	15	0	-15	5.48
	Shun Tat Street - EB	IB	15	5	-10	3.16	85	65	-20	2.31	100	70	-30	3.25
	Tat Fuk Road - SB	IB	0	0	0	0.00	0	0	0	0.00	0	0	0	0.00
	<b>Total</b>	<b>IB</b>	<b>30</b>	<b>10</b>	<b>-20</b>	<b>4.47</b>	<b>150</b>	<b>125</b>	<b>-25</b>	<b>2.13</b>	<b>180</b>	<b>135</b>	<b>-45</b>	<b>3.59</b>
Exit Arm	Shun Tat Street - WB	OB	5	5	0	0.00	65	65	0	0.00	70	70	0	0.00
	Tat Fuk Road - NB	OB	10	0	-10	4.47	20	0	-20	6.32	30	0	-30	7.75
	Shun Tat Street - EB	OB	15	5	-10	3.16	65	60	-5	0.63	80	65	-15	1.76
	Tat Fuk Road - SB	OB	0	0	0	0.00	0	0	0	0.00	0	0	0	0.00
	<b>Total</b>	<b>OB</b>	<b>30</b>	<b>10</b>	<b>-20</b>	<b>4.47</b>	<b>150</b>	<b>125</b>	<b>-25</b>	<b>2.13</b>	<b>180</b>	<b>135</b>	<b>-45</b>	<b>3.59</b>

J7 - Shun Tat Street/ Tung Fuk Road/ Access Road to North West N.T. Refuse Transfer Station														
	Street Name	Dir'n	PV (pcu/hr)				GV (pcu/hr)				Total = PV+GV+PT (pcu/hr)			
			Obs.	Mod.	Diff.	GEH	Obs.	Mod.	Diff.	GEH	Obs.	Mod.	Diff.	GEH
Entry Arm	Shun Tat Street - WB	IB	0	0	0	0.00	0	0	0	0.00	0	0	0	0.00
	Tung Fuk Road	IB	0	0	0	0.00	0	0	0	0.00	0	0	0	0.00
	Shun Tat Street - EB	IB	0	0	0	0.00	65	65	0	0.00	65	65	0	0.00
	Access Road to North West N.T. Refuse Transfer S	IB	5	5	0	0.00	60	60	0	0.00	65	65	0	0.00
	<b>Total</b>	<b>IB</b>	<b>5</b>	<b>5</b>	<b>0</b>	<b>0.00</b>	<b>125</b>	<b>125</b>	<b>0</b>	<b>0.00</b>	<b>130</b>	<b>130</b>	<b>0</b>	<b>0.00</b>
Exit Arm	Shun Tat Street - WB	OB	0	0	0	0.00	0	0	0	0.00	0	0	0	0.00
	Tung Fuk Road	OB	0	0	0	0.00	10	10	0	0.00	10	10	0	0.00
	Shun Tat Street - EB	OB	5	5	0	0.00	60	60	0	0.00	65	65	0	0.00
	Access Road to North West N.T. Refuse Transfer S	OB	0	0	0	0.00	55	55	0	0.00	55	55	0	0.00
	<b>Total</b>	<b>OB</b>	<b>5</b>	<b>5</b>	<b>0</b>	<b>0.00</b>	<b>125</b>	<b>125</b>	<b>0</b>	<b>0.00</b>	<b>130</b>	<b>130</b>	<b>0</b>	<b>0.00</b>

**J8 - Castle Peak Road (Lam Tei)/ Fuk Hang Tsuen Road**

	Street Name	Dir'n	PV (pcu/hr)				GV (pcu/hr)				Total = PV+GV+PT (pcu/hr)			
			Obs.	Mod.	Diff.	GEH	Obs.	Mod.	Diff.	GEH	Obs.	Mod.	Diff.	GEH
Entry Arm	Castle Peak Road (Lam Tei) - SB	IB	685	705	20	0.76	430	415	-15	0.73	1240	1245	5	0.14
	Fuk Hang Tsuen Road	IB	290	225	-65	4.05	105	35	-70	8.37	415	280	-135	7.24
	Castle Peak Road (Lam Tei) - NB	IB	810	820	10	0.35	730	765	35	1.28	1745	1790	45	1.07
	<b>Total</b>	<b>IB</b>	<b>1785</b>	<b>1750</b>	<b>-35</b>	<b>0.83</b>	<b>1265</b>	<b>1215</b>	<b>-50</b>	<b>1.42</b>	<b>3400</b>	<b>3315</b>	<b>-85</b>	<b>1.47</b>
Exit Arm	Castle Peak Road (Lam Tei) - SB	OB	710	710	0	0.00	720	750	30	1.11	1615	1645	30	0.74
	Fuk Hang Tsuen Road	OB	275	225	-50	3.16	90	25	-65	8.57	385	270	-115	6.35
	Castle Peak Road (Lam Tei) - NB	OB	800	815	15	0.53	455	440	-15	0.71	1400	1400	0	0.00
	<b>Total</b>	<b>OB</b>	<b>1785</b>	<b>1750</b>	<b>-35</b>	<b>0.83</b>	<b>1265</b>	<b>1215</b>	<b>-50</b>	<b>1.42</b>	<b>3400</b>	<b>3315</b>	<b>-85</b>	<b>1.47</b>

**J9 - Hung Tin Road/ Castle Peak Road (Hung Shui Kiu)**

	Street Name	Dir'n	PV (pcu/hr)				GV (pcu/hr)				Total = PV+GV+PT (pcu/hr)			
			Obs.	Mod.	Diff.	GEH	Obs.	Mod.	Diff.	GEH	Obs.	Mod.	Diff.	GEH
Entry Arm	Castle Peak Road (Hung Shui Kiu) - NB	IB	595	655	60	2.40	400	425	25	1.23	1230	1315	85	2.38
	Hung Tin Road	IB	300	240	-60	3.65	185	140	-45	3.53	510	405	-105	4.91
	Castle Peak Road (Hung Shui Kiu) - SB	IB	515	550	35	1.52	260	275	15	0.92	960	1010	50	1.59
	<b>Total</b>	<b>IB</b>	<b>1410</b>	<b>1445</b>	<b>35</b>	<b>0.93</b>	<b>845</b>	<b>840</b>	<b>-5</b>	<b>0.17</b>	<b>2700</b>	<b>2730</b>	<b>30</b>	<b>0.58</b>
Exit Arm	Castle Peak Road (Hung Shui Kiu) - NB	OB	510	495	-15	0.67	275	260	-15	0.92	950	920	-30	0.98
	Hung Tin Road	OB	400	400	0	0.00	255	225	-30	1.94	735	705	-30	1.12
	Castle Peak Road (Hung Shui Kiu) - SB	OB	500	550	50	2.18	315	355	40	2.19	1015	1105	90	2.76
	<b>Total</b>	<b>OB</b>	<b>1410</b>	<b>1445</b>	<b>35</b>	<b>0.93</b>	<b>845</b>	<b>840</b>	<b>-5</b>	<b>0.17</b>	<b>2700</b>	<b>2730</b>	<b>30</b>	<b>0.58</b>

**J11 - Yuen Long Highway/ Hung Tin Road**

	Street Name	Dir'n	PV (pcu/hr)				GV (pcu/hr)				Total = PV+GV+PT (pcu/hr)			
			Obs.	Mod.	Diff.	GEH	Obs.	Mod.	Diff.	GEH	Obs.	Mod.	Diff.	GEH
Entry Arm	Yuen Long Highway - NB	IB	2650	2585	-65	1.27	2465	2215	-250	5.17	5275	4960	-315	4.40
	Hung Tin Road	IB	1270	945	-325	9.77	865	895	30	1.01	2170	1875	-295	6.56
	Yuen Long Highway - SB	IB	2365	2240	-125	2.61	1750	1690	-60	1.45	4245	4060	-185	2.87
	<b>Total</b>	<b>IB</b>	<b>6285</b>	<b>5770</b>	<b>-515</b>	<b>6.63</b>	<b>5080</b>	<b>4800</b>	<b>-280</b>	<b>3.98</b>	<b>11690</b>	<b>10895</b>	<b>-795</b>	<b>7.48</b>
Exit Arm	Yuen Long Highway - NB	OB	2735	2290	-445	8.88	1705	1675	-30	0.73	4600	4125	-475	7.19
	Hung Tin Road	OB	1160	1175	15	0.44	1375	1175	-200	5.60	2570	2385	-185	3.72
	Yuen Long Highway - SB	OB	2390	2305	-85	1.75	2000	1950	-50	1.13	4520	4385	-135	2.02
	<b>Total</b>	<b>OB</b>	<b>6285</b>	<b>5770</b>	<b>-515</b>	<b>6.63</b>	<b>5080</b>	<b>4800</b>	<b>-280</b>	<b>3.98</b>	<b>11690</b>	<b>10895</b>	<b>-795</b>	<b>7.48</b>

**J12 - Yuen Long Highway/ Kong Sham Western Highway**

	Street Name	Dir'n	PV (pcu/hr)				GV (pcu/hr)				Total = PV+GV+PT (pcu/hr)			
			Obs.	Mod.	Diff.	GEH	Obs.	Mod.	Diff.	GEH	Obs.	Mod.	Diff.	GEH
Entry Arm	Yuen Long Highway - NB	IB	2595	2780	185	3.57	2365	2325	-40	0.83	5140	5285	145	2.01
	Kong Sham Western Highway	IB	300	290	-10	0.58	420	425	5	0.24	790	785	-5	0.18
	Yuen Long Highway - SB	IB	2735	2290	-445	8.88	1705	1675	-30	0.73	4600	4125	-475	7.19
	<b>Total</b>	<b>IB</b>	<b>5630</b>	<b>5360</b>	<b>-270</b>	<b>3.64</b>	<b>4490</b>	<b>4425</b>	<b>-65</b>	<b>0.97</b>	<b>10530</b>	<b>10195</b>	<b>-335</b>	<b>3.29</b>
Exit Arm	Yuen Long Highway - NB	OB	2610	2475	-135	2.68	1895	1860	-35	0.81	4670	4500	-170	2.51
	Kong Sham Western Highway	OB	60	60	0	0.00	125	115	-10	0.91	250	240	-10	0.64
	Yuen Long Highway - SB	OB	2650	2585	-65	1.27	2465	2215	-250	5.17	5275	4960	-315	4.40
	<b>Total</b>	<b>OB</b>	<b>5320</b>	<b>5120</b>	<b>-200</b>	<b>2.77</b>	<b>4485</b>	<b>4190</b>	<b>-295</b>	<b>4.48</b>	<b>10195</b>	<b>9700</b>	<b>-495</b>	<b>4.96</b>



## **APPENDIX B**

# **Traffic Modelling Assumptions**

## **INTRODUCTION**

- 1.1 The purpose of this Section is to set out the forecasting assumptions to be adopted in the traffic forecasts. They include the following:
- Population and Employment Assumptions;
  - Development Assumptions for AOI;
  - Economic Growth;
  - Vehicle Fleet Sizes;
  - Highway and Railway Network Assumptions;
  - Highway Toll Assumptions;
  - International Travel Assumptions;
  - Port Assumptions; and
  - Cross Boundary Traffic Assumptions.
- 1.2 The Study is now undergoing the data review and collection stage and base year information including both the observed traffic and transport data as well as the existing model input data will be assembled. The model forecasting years for this Study will be 2034.
- 1.3 To speed up the process of agreeing the model input assumptions for both base year and design years, some of the planning parameters are proposed below in parallel with the data collection process from relevant Government departments. The model input assumptions will be further updated upon receipt of latest information provided by Government.

## **POPULATION AND EMPLOYMENT ASSUMPTIONS**

- 2.1 The 2018 population and employment data from Hong Kong 2030+ Territorial Population and Employment Data Matrices (TPEDM) (2021 Update) will be adopted for base year 2018.
- 2.2 Population and employment assumptions for 2026, 2031 and 2036 are based on the 2019-based TPEDM dataset, the latest available planning forecasts released by Planning Department.

## **DEVELOPMENT ASSUMPTIONS FOR AOI**

- 3.1 The 2019-based TPEDM will be the primary source of population and employment assumptions to be adopted in the traffic forecast of the Study.
- 3.2 In addition, the planned/committed developments in the vicinity of the proposed development have also been identified and listed below.
- Housing Development at Tuen Mun Central  
(refer to Tuen Mun DC Paper No. 2019/9 dated 5 March 2019 and No. 2020/71 dated 18 September 2020)
  - Housing Development at San Hing Road and Hong Po Road  
(refer to Tuen Mun DC Paper No. 2021/29 dated 6 July 2021)
  - Lam Tei Quarry and the Adjoining Areas  
(refer to Tuen Mun DC Paper No. 2015/20 dated 5 May 2015)
  - Tuen Mun Areas 40 and 46 Development  
(refer to LC Paper CB(1)105/15-16(03) dated 10 Nov 2015)
  - Tuen Mun Areas 38 and 49 Development  
(refer to LC Paper CB(4)1306/14-15(04) dated 19 Mar 2021)
  - Lam Tei Quarry and the Adjoining Areas  
(refer to Tuen Mun DC Paper 2015/20 dated 5 May 2015)

## **ECONOMIC GROWTH**

- 4.1 Economic growth assumptions are presented in **Table 4.1** based on information in the Gross Domestic Product (Quarterly) (Second Quarter 2021), 2020-21 Budget Speech and recent Government studies.

**Table 4.1 GDP Growth Assumption**

<b>Year</b>	<b>Real GDP Growth</b>
2019	-1.7%
2020	-6.1%
2021	4.5%
2022-2025	3.3% p.a.
2026 and beyond	2.5% p.a.

Sources:

1. 2019-2020 data taken from “Gross Domestic Product (Quarterly) (Second Quarter 2021)” by Census and Statistics Department, HKSAR.
2. 2021-2025 data taken from the 2020-21 Budget Speech, 24 February 2021.
3. 2026-2041 data assumed to follow recent Government studies.

## **VEHICULE FLEET SIZES**

5.1 The projections on private vehicle and goods vehicle fleet sizes are assumed as shown in Table 5.1.

**Table 5.1 Vehicle Fleet Sizes**

<b>Year</b>	<b>Mid-Year Fleet Size</b>	
	<b>Private Vehicle (Private Cars and Motorcycles)</b>	<b>Goods Vehicle</b>
2021	669,000	115,500
2026	738,700	118,400
2031	811,600	121,400
2036	853,000	124,400
2041	896,500	127,600

## HIGHWAY AND RAILWAY NETWORK ASSUMPTIONS

### Highway Network Assumptions

- 6.1 The strategic highway network assumptions are presented in **Tables 6.1** to **6.4** for years 2026, 2031 and 2036.
- 6.2 The proposed road network assumptions represents the Reference Case traffic situation before commissioning of the Proposed Works. The Design Case traffic situation after commissioning of the Proposed Works will then be assessed by including the Proposed Works in addition to the road networks assumed in the Reference Case for each of the design years.

**Table 6.1 2021 Strategic Road Network Assumptions**

<b>2021 Road Network Assumption (In Addition To 2019 Network<sup>1</sup>)</b>	<b>Configuration</b>
<b>Kowloon</b>	
Road Improvement Works in West Kowloon Reclamation Development (Widening of Nga Cheung Road)	S1
Road Improvement Works for South East Kowloon Development	S2/D2/D3 <sup>1</sup>
<b>New Territories</b>	
Route 6 – Tseung Kwan O – Lam Tin Tunnel	D2
Dualling of Hiram's Highway between Clear Water Bay Road & Marina Cove	D2
Tuen Mun - Chek Lap Kok Link (northern section i.e. from Tuen Mun to HKBCF)	D2
Widening of Castle Peak Road (Castle Peak Bay Section)	D2
Liantang/Heung Yuen Wai Cross-Boundary Control Point <sup>2</sup>	
Widening of Tolo Highway/Fanling Highway between Island House Interchange and Fanling (Stage 2 – Section Between Tai Hang and Wo Hop Shek Interchange)	D4

Note:

1. The configuration of these proposed highways varies at different sections of the road.
2. While the Link Road to Liantang/Heung Yuen Wai Cross-Boundary Control Point is completed in 2019, Liantang/Heung Yuen Wai Cross-Boundary Control Point is assumed to be operation by 2021 onward.

**Table 6.2 2026 Strategic Road Network Assumptions**

<b>2026 Road Network Assumption (In Addition To 2021 Network)</b>	<b>Configuration</b>
<b>Kowloon</b>	
Road Improvement Works for South East Kowloon Development	S2/D2/D3 <sup>1</sup>
Route 6 - Central Kowloon Route	D3
Route 6 – Trunk Road T2 (Kai Tak – Cha Kwo Ling Link)	D2
Widening of Gascoigne Road Flyover	D2
<b>New Territories</b>	
Cross Bay Link at Tseung Kwan O	D2
North Lantau Road P1 (Tung Chung East to Tai Ho Section)	D2
Fanling Bypass Eastern Section	D2
Widening of Tai Po Road (existing remaining D2 Sha Tin Section)	D3
Improvement to Fan Kam Road	S2
Flyover from Kwai Tsing Interchange Up ramp to Kwai Chung Road	S1

Note:

1. The configuration of these proposed highways varies at different sections of the road.

**Table 6.3 2031 Strategic Road Network Assumptions**

<b>2031 Road Network Assumption (In Addition To 2026 Network)</b>	<b>Configuration</b>
<b>New Territories</b>	
Widening of Tsuen Wan Road, Extension of Existing Vehicular Bridge at Texaco Road and the Associated Junction Improvement Works	D4/D5 <sup>1</sup>
Road Improvement Works in Hung Shui Kiu New Development Area	D2
Widening of Fanling Highway between Pak Shek Au Interchange and Po Shek Wu Interchange	D4
Dualling of Hiram's Highway between Marina Cove and Sai Kung Town	D2
Trunk Road T4	D2
North Lantau Road P1 (Tai Ho to Sunny Bay Section)	D2

Note:

1. The configuration of these proposed highways varies at different sections of the road.



**Table 6.4 2036 Strategic Road Network Assumptions**

<b>2036 Road Network Assumption (In Addition To 2031 Network)</b>	<b>Configuration</b>
<b>New Territories</b>	
Route 11 including Lam Tei Tunnel, So Kwun Wat Link Road, Tai Lam Chung Tunnel and Tsing Lung Bridge <sup>1</sup>	D3
Tsing Yi – Lantau Link	D3
Road Improvement Works in Yuen Long South Development	D2
Upgrading of Lung Mun Road	D2/D3/D4 <sup>2</sup>
Tuen Mun Bypass	D2

Note:

1. Route 11 is assumed to be connected to Tuen Mun Road and North Lantau Highway, with connections between Tuen Mun, Tung Chung and Urban
2. The configuration of these proposed highways varies at different sections of the road.

**Railway Network Assumptions**

- 6.3 The future railway network assumptions are presented in Table 6.5 for years 2026. No additional railway network will be assumed for years 2031 and 2036.

**Table 6.5 Railway Network Assumptions**

<b>By 2026 - 2030 (In Addition to Existing Network)</b>
Shatin to Central Link (Hung Hom to Admiralty Section)
Northern Link Phase 1
Kwu Tung Station
Tuen Mun South Extension
East Kowloon Line
Hung Shui Kiu Station
South Island Line (West)
North Island Line
Tung Chung West Extension
Tung Chung East Station
Siu Ho Wan Station
<b>By 2031 - 2035 (In Addition to 2026 Network)</b>
Northern Link Phase 2
<b>No additional railway network will be assumed for year 2036</b>

## HIGHWAY TOLL ASSUMPTION

7.1 Toll assumptions are presented in Table 7.1. It is assumed that the toll structures and levels of all existing tunnels will remain as current and increase in line with inflation, i.e. constant in real terms.

Table 7.1 Toll Assumptions (in 2021 HK\$)

Toll Facility	Car/ Taxi	Light Bus	Light Goods Vehicle	Medium Goods Vehicle	Heavy Goods Vehicle	Tractor Unit	Single- decked Buses	Double- decked Buses
<b>Existing Toll Facilities</b>								
Shing Mun Tunnels	5	5	5	5	5	5	5	5
Lion Rock Tunnel (LRT)	8	8	8	8	8	8	8	8
Sha Tin Heights Tunnel and Eagle's Nest Tunnel (ENT)	8	8	8	8	8	8	8	8
Tate's Cairn Tunnel (TCT) <sup>(1)</sup>	20	24	24	28	28	52	32	35
Tseung Kwan O (TKO) Tunnel	0	0	0	0	0	0	0	0
Eastern Harbour Crossing (EHC)	25	38	38	50	75	100	50	75
Cross Harbour Tunnel (CHT)	20/10	10	15	20	30	40	10	15
Western Harbour Crossing (WHC) <sup>(2)</sup>	75/70	85	85	110	140	170	140	200
Aberdeen Tunnel	5	5	5	5	5	5	5	5
Lantau Link <sup>(3)</sup>	0	0	0	0	0	0	0	0
Tai Lam Tunnel (R3-CPS) <sup>(4)</sup>	48	100	49	55	60	60	143	168
<b>Future Toll Facilities</b>								
TKO – Lam Tin Tunnel <sup>(6)</sup>	0	0	0	0	0	0	0	0
Tuen Mun-Chek Lap Kok Link (TM-CLKL) <sup>(6)</sup>	0	0	0	0	0	0	0	0

**Agreement No. CE 92/2017 (CE)**  
**Site Formation and Infrastructure Works for Public Housing**  
**Development near Tan Kwai Tsuen, Yuen Long**  
**– Investigation, Design and Construction**

Toll Facility	Car/ Taxi	Light Bus	Light Goods Vehicle	Medium Goods Vehicle	Heavy Goods Vehicle	Tractor Unit	Single- decked Buses	Double- decked Buses
Tuen Mun Bypass (TMB) <sup>(6)</sup>	24	50	25	28	30	30	72	84
Route 11-Lam Tei Tunnel <sup>(6)</sup>	24	50	25	28	30	30	72	84
Route 11-So Kwun Wat Link Road <sup>(6)</sup>	12	25	13	14	15	15	36	42

Notes:

1. Based on new tolls for Tate's Cairn Tunnel effective from January 2016.
2. Based on new tolls for Western Harbour Crossing effective from June 2019.
3. Toll waiver was implemented for Lantau Link and Tuen Mun-Chek Lap Kok Link starting from 27 December 2020.
4. Based on new tolls for Tai Lam Tunnel effective from January 2019.
5. It is assumed that the toll structures and levels of all existing tunnels/bridge will remain as current and increase in line with inflation, i.e. constant in real terms.
6. Tolls on the future new toll facilities are assumed to follow the equivalent amount as for an equivalent existing facility in general. For example, traffic on the TKO – Lam Tin Tunnel will pay the same as Tseung Kwan O Tunnel. The tolls level of TMB assumed to be half of Tai Lam tunnel (Route 3). Toll levels on the future Route 11 Lam Tei Tunnel are assumed to be half of the tolls levied on the existing Tai Lam Tunnel whilst the tolls at So Kwun Wat Link Road will be assumed at one-fourth of the toll levels of Tai Lam Tunnel.

## **PORT ASSUMPTIONS**

- 8.1 The port traffic assumptions are based on the “Study on the Strategic Development Plan for Hong Kong Port 2030”. Details are shown in **Table 8.1**.
- 8.2 No new container terminal port will be assumed in the forecasts.

**Table 8.1 Port Demand Assumptions (In Million TEU’s per year)**

<b>Year</b>	<b>2019</b>	<b>2026</b>	<b>2031</b>	<b>2036</b>
<b>CT 1-9</b>	14	23	25	25

Sources:

1. 2019 data taken from the Hong Kong Annual Digest of Statistics.
2. 2026-2031 data taken from the Strategic Development Plan for Hong Kong Port 2030 Study.

## **INTERNATIONAL TRAVEL ASSUMPTIONS**

9.1 Airport usage forecasts are shown in Table 9.1 and will be incorporated in the forecasts.

**Table 9.1 HKIA Usage Forecasts**

<b>Year</b>	<b>2016</b>	<b>2026</b>	<b>2031</b>	<b>2036</b>
Daily Air Passengers (Thousand Passengers)	136	185	215	243
Daily Air Cargo (Thousand Tonnes)	9	14	17	19

Notes:

1. 2036 and 2041 data estimated by extrapolation of 2031 and 2035 data provided by AAHK.

## **OTHER ASSUMPTIONS**

10.1 The following parameters is undergoing data collection process from relevant Government departments. The model input assumptions will be further updated upon receipt of latest information provided by Government.

- Cross Boundary Traffic Assumptions.

19. The Tuen Mun South Extension will extend from the existing terminal of Tuen Mun Station southwards to Tuen Mun South with the indicative implementation window between 2019 and 2022.

20. We will implement each of the new railway projects recommended under the “Railway Development Strategy 2014” in accordance with the established mechanism and procedures. We will start the detailed planning works, including an in-depth feasibility study to ascertain the relevant justifications, detailed alignments, locations of stations, implementation timetables, implementation approaches and funding methods, etc. We will also consult the public and the District Councils, and submit the funding application for proceeding with the design works of the projects.

21. When conducting detailed planning of the new railway projects in respect of Northern Link and Kwu Tung Station, Tuen Mun South Extension and Hung Shui Kiu Station, etc., we will refer to the continually updated planning parameters. We will also carefully review the actual traffic situations, including the possible implications upon the existing railway lines after expanding the railway networks, and the corresponding improvement schemes. Before the completion of the new railway projects, the Transport Department will also assess the change in the needs and mode choices for trip making of the residents after the commissioning of these railway projects, as well as the implications to other road based public transport. The Transport Department will also prepare rationalization schemes for improving the coordination among various means of public transport such that the road traffic and the railways can complement to each other.

22. With consideration of the facilities along the “East-West Corridor”, such as the fire safety requirements at tunnel sections and the length of platforms etc., we currently estimate that the “East-West Corridor” can ultimately reach an hourly frequency of 28 at each direction, with 8-car trains. On this basis, the carrying capacity of the WRL will increase by 60% over the current 7-car trains operating at an hourly frequency of about 20 (inclusive of the 37% increase mentioned in paragraph 15). In this regard, we will request MTRCL to enhance the services of the WRL by increasing the train frequency.

23. Upon completion of the above three new railway projects, i.e. Northern Link and Kwu Tung Station, Tuen Mun South Extension and Hung Shui Kiu

## **APPENDIX C**

# **Phasing Plan for Road Network under CE2/2011**





# **APPENDIX C1**

## **Proposed Conceptual Layout of**

### **Castle Peak Road/ Yick Yuen Road**

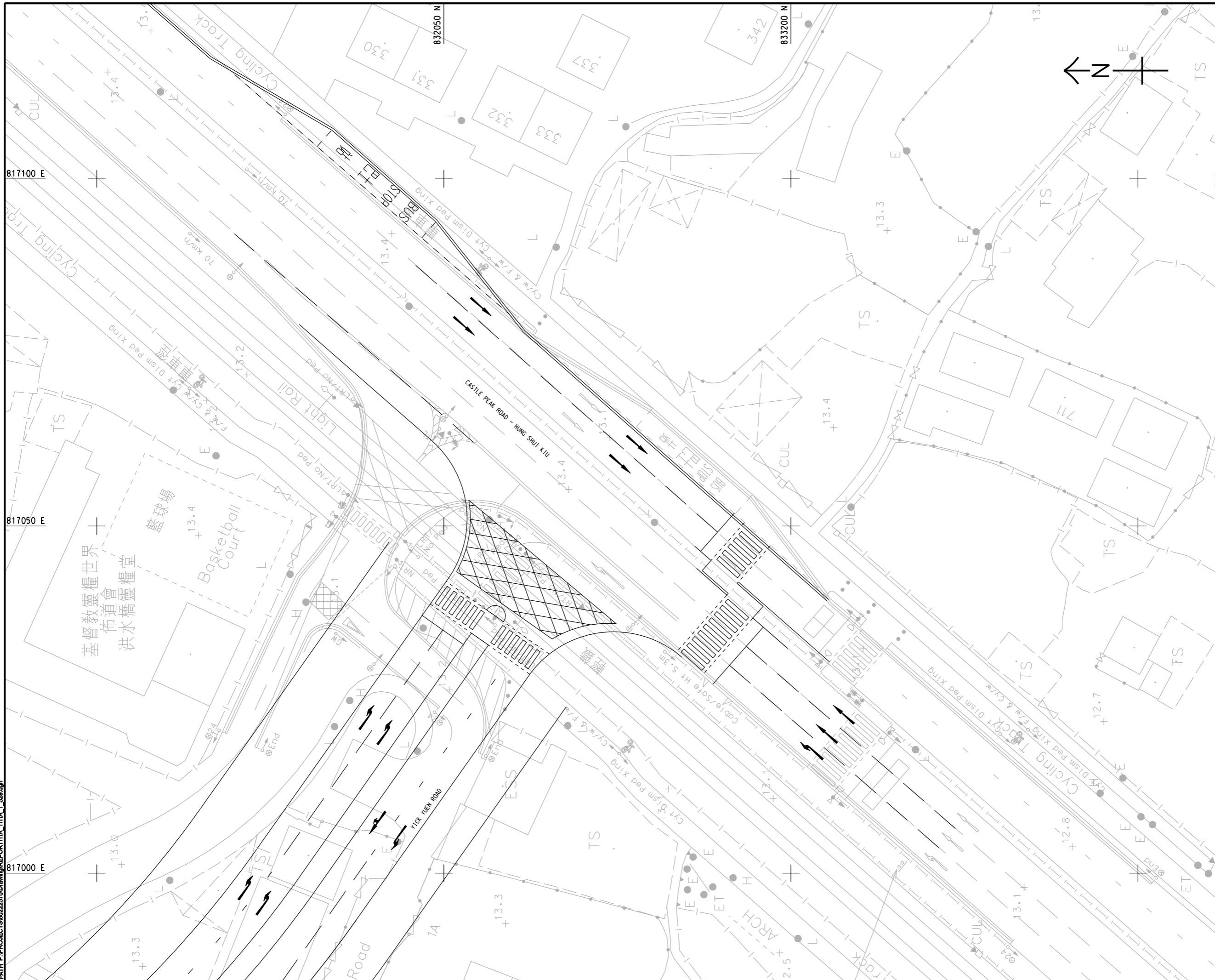

**PROJECT**  
項目

**HUNG SHUI KIU NEW DEVELOPMENT AREA PLANNING AND ENGINEERING STUDY - INVESTIGATION**

**CLIENT**  
業主

**CEDD**  
土木工程拓展署  
Civil Engineering and Development Department

**Planning Department**  
規劃署

**CONSULTANT**  
工程顧問公司

AECOM Asia Company Ltd.  
www.aecom.com

**SUB-CONSULTANTS**  
分判工程顧問公司

**ISSUE/REVISION**  
修訂

IR	DATE	DESCRIPTION	CHK
號	日期	內容摘要	號

**STATUS**  
階段

**SCALE**  
比例

A1 1:250

**DIMENSION UNIT**  
尺寸單位

METERS

**KEY PLAN**  
索引圖

**PROJECT NO.**  
項目編號

60222570

**AGREEMENT NO.**  
協議編號

CE2/2011 (CE)

**SHEET TITLE**  
圖號/片名

PROPOSED CONCEPTUAL LAYOUT OF CASTLE PEAK ROAD / YICK YUEN ROAD (J31)

**SHEET NUMBER**  
圖號/片號

60222570/TIA\_1/APPENDIX 5.1.7

This drawing has been prepared for the use of AECOM's client. It may not be used, modified, reproduced or relied upon by third parties, except as agreed by AECOM or as required by law. AECOM accepts no responsibility, and denies any liability whatsoever, to any party, for uses or reliance on this drawing without AECOM's express written consent. Do not scale this document. All measurements must be obtained from the stated dimensions.



## **APPENDIX C2**

# **Proposed Conceptual Layout of Castle Peak Road/ Road P1**

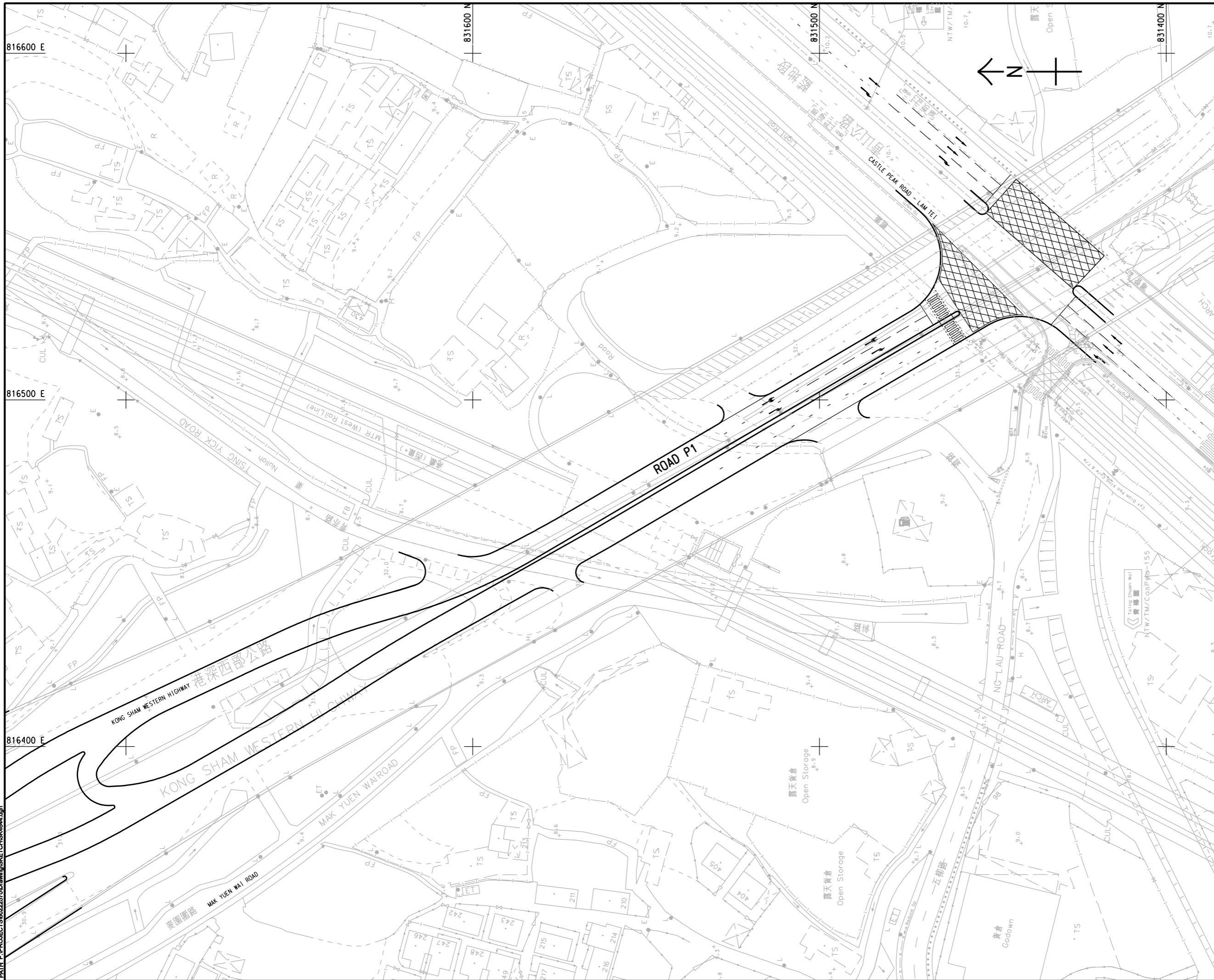
Pd4 File by: CHENWZA\_2017106  
 PATH: P:\PROJECTS\20222570\Drawing\SKETCH\CHSK4044.dgn  
 Project Management Initials: Designer: Checked: Approved: ISO A1 594mm x 841mm



**PROJECT**  
 項目  
**HUNG SHUI KIU NEW DEVELOPMENT AREA PLANNING AND ENGINEERING STUDY - INVESTIGATION**

**CLIENT**  
 業主  
   
 土木工程拓展署 規劃署  
 Civil Engineering and Development Department Planning Department

**CONSULTANT**  
 工程顧問公司  
 AECOM Asia Company Ltd.  
 www.aecom.com

**SUB-CONSULTANTS**  
 分判工程顧問公司

**ISSUE/REVISION**  
 修訂

IR/修訂	DATE/日期	DESCRIPTION/內容摘要	CHK/核對

**STATUS**  
 階段

**SCALE**  
 比例  
 A3 1:1000

**DIMENSION UNIT**  
 尺寸單位  
 METRES

**KEY PLAN** A3 1:50000  
 索引圖

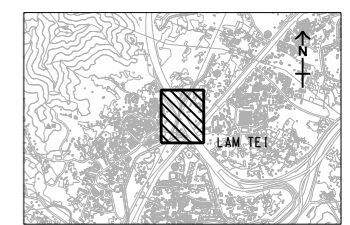

**PROJECT NO.**  
 項目編號  
 60222570

**AGREEMENT NO.**  
 協議編號  
 CE2/2011 (CE)

**SHEET TITLE**  
 圖紙名稱  
**PROPOSED CONCEPTUAL LAYOUT OF CASTLE PEAK ROAD/ROAD P1 (J42)**

**SHEET NUMBER**  
 圖紙編號  
 60222570/TIA\_1/APPENDIX 5.1.15

This drawing has been prepared for the use of AECOM's client. It may not be used, modified, reproduced or relied upon by third parties, except as required by law. AECOM accepts no responsibility, and denies any liability whatsoever, for any party that uses or relies on this drawing without AECOM's express written consent. Do not scale this document. All measurements must be obtained from the stated dimensions.

## **APPENDIX C3**

# **Proposed Improvement Scheme of Castle Peak Road/ Fuk Hang Tsuen Road**



# **APPENDIX D1**







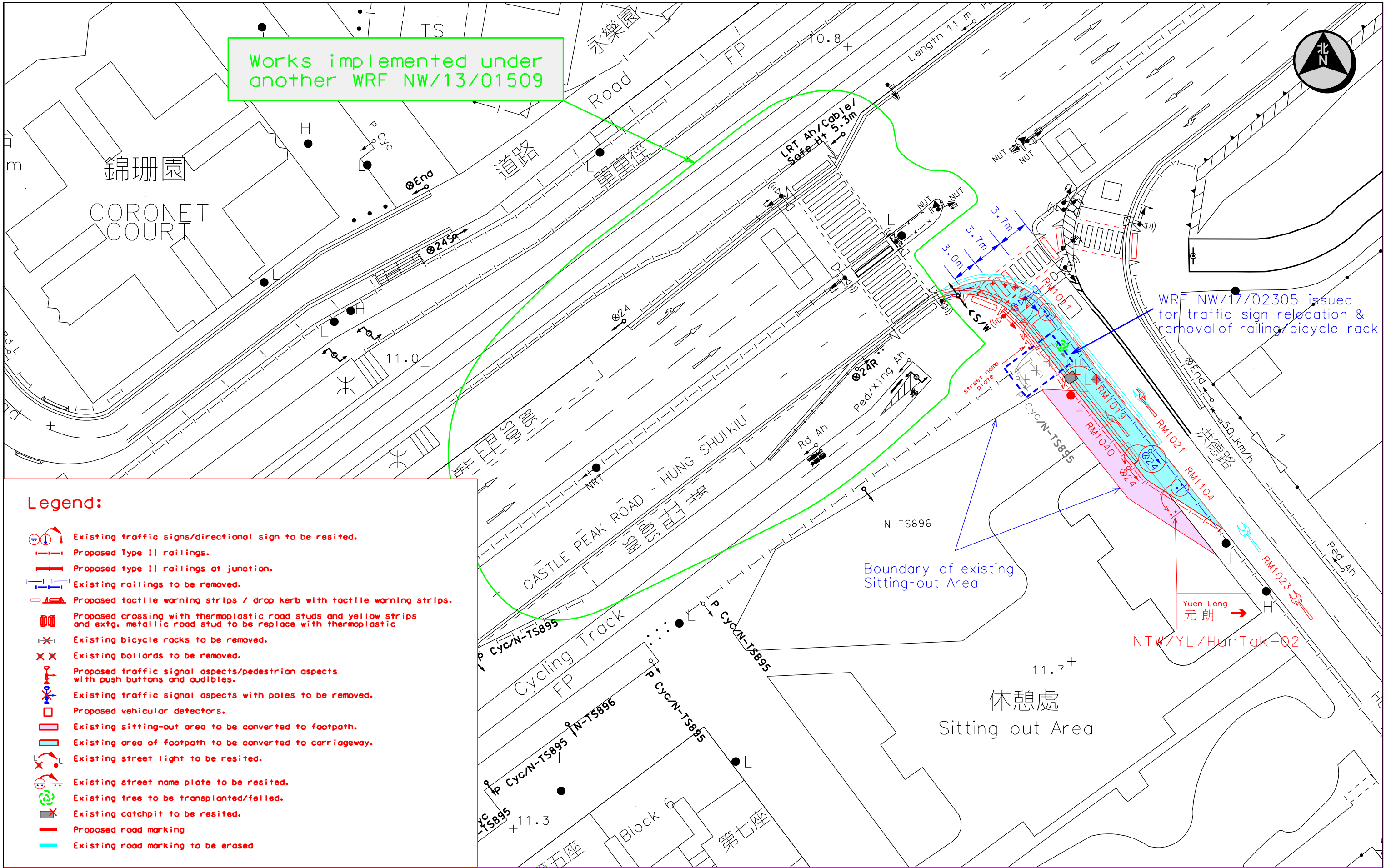











## **TD's Proposed Improvement Works for Junction of Castle Peak Road / Hung Tak Road**



Works implemented under another WRF NW/13/01509



**Legend:**

-  Existing traffic signs/directional sign to be resited.
-  Proposed Type II railings.
-  Proposed type II railings at junction.
-  Existing railings to be removed.
-  Proposed tactile warning strips / drop kerb with tactile warning strips.
-  Proposed crossing with thermoplastic road studs and yellow strips and extg. metallic road stud to be replace with thermoplastic
-  Existing bicycle racks to be removed.
-  Existing bollards to be removed.
-  Proposed traffic signal aspects/pedestrian aspects with push buttons and audibles.
-  Existing traffic signal aspects with poles to be removed.
-  Proposed vehicular detectors.
-  Existing sitting-out area to be converted to footpath.
-  Existing area of footpath to be converted to carriageway.
-  Existing street light to be resited.
-  Existing street name plate to be resited.
-  Existing tree to be transplanted/felled.
-  Existing catchpit to be resited.
-  Proposed road marking
-  Existing road marking to be erased

TRAFFIC ENGINEERING (NTW) DIVISION.

LOCATION:

DRAWING NO.: W130043.008

J/O Castle Peak Road - Hung Shui Kiu / Hung Tak Road, Yuen Long











SCALE: 1:400 in A3



## **APPENDIX D2**

# **TD's Proposed Improvement Works for Junction of Castle Peak Road / Shun Tat Street**

**Legend:**

-  Remove existing traffic sign
-  Existing directional sign to be resited
-  Proposed beam barrier
-  Existing beam barrier to be removed
-  Existing area to be converted to carriageway
-  Proposed traffic bollard
-  Existing traffic bollard to be removed
-  Proposed traffic signal aspect with pole
-  Existing traffic signal aspect with pole to be removed
-  Proposed traffic island (2m x 1.5m)
-  To paint road marking as shown in red
-  To remove road marking as shown in blue

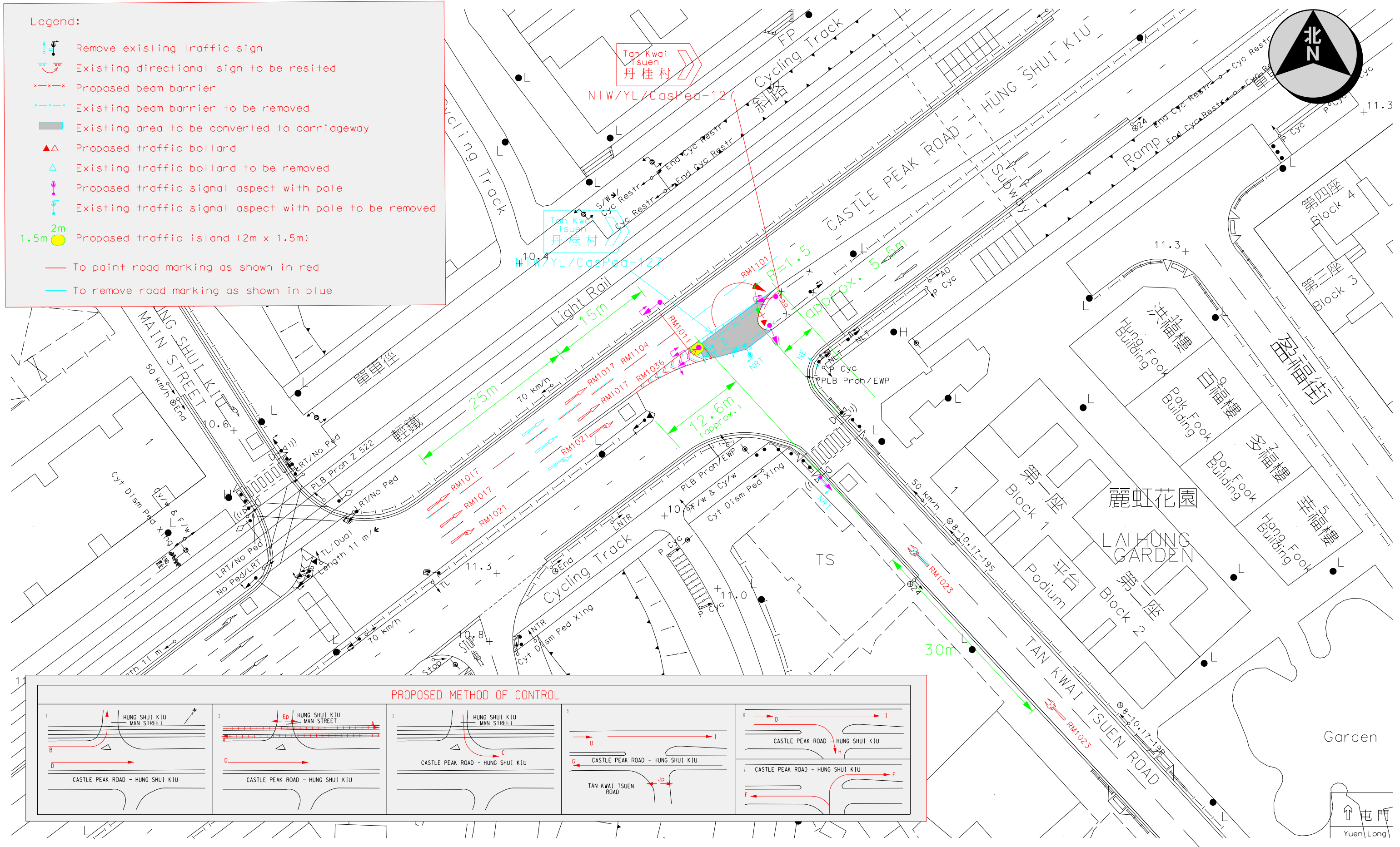

**PROPOSED METHOD OF CONTROL**

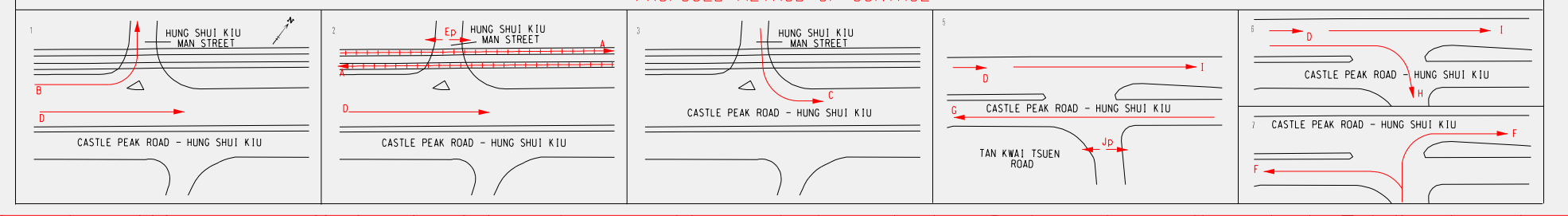

## **APPENDIX D3**

# **TD's Proposed Improvement Works for Junction of Castle Peak Road / Tan Kwai Tsuen Road**

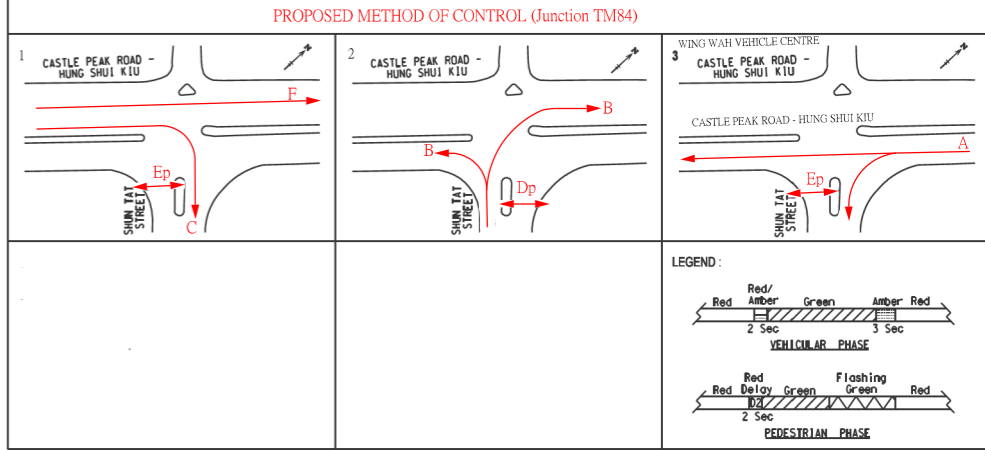
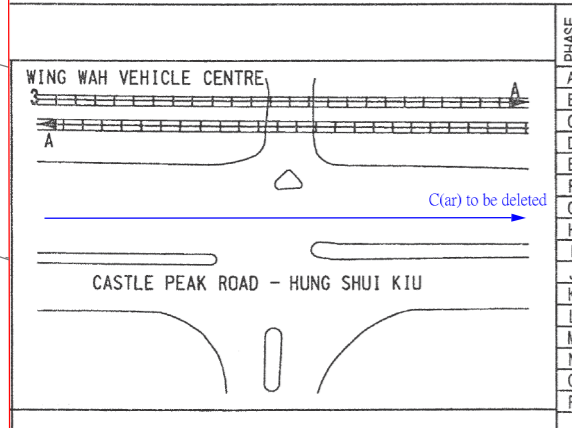
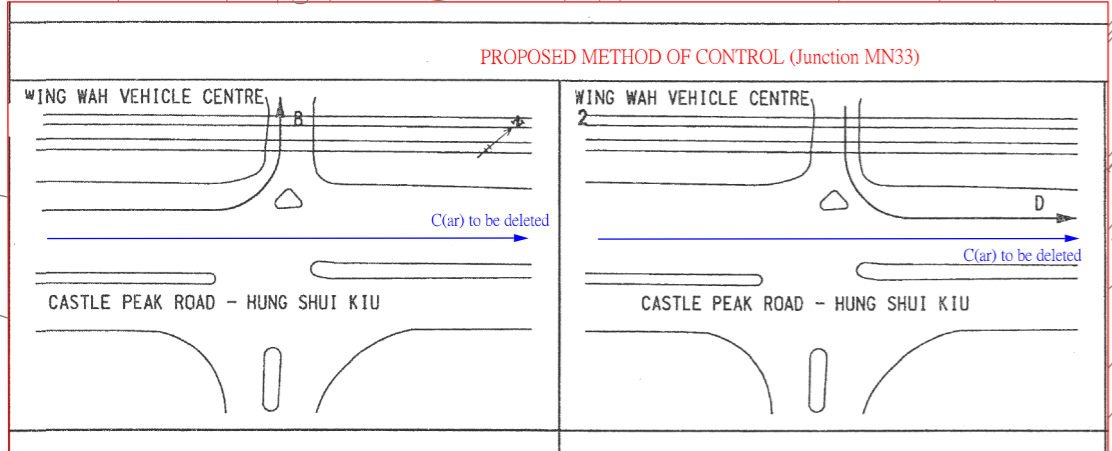

- Legend**
- To be implemented by HyD
- Extg. 1 no. street name sign to be resited
  - Extg. 2 nos. T.S.107 "Turn Left" under signal aspects to be removed
  - Proposed 1 no. T.S.132 "No Right Turns", 3 nos. T.S.133 "No U Turns" and 1 no. T.S.175 "Speed Limit 70km/h"
  - Extg. C/W markings to be erased
  - Proposed C/W markings RM1011, RM1017, RM1023, RM1025, RM1036, RM1037, RM1101 and RM1104
  - Extg. central divider to be removed and converted into carriageway
  - Extg. carriageway to be converted into central island
  - Extg. 1 no. vehicular signal pole to be removed
  - Proposed 2 nos. vehicular signal pole
  - Extg. 1 no. keep left yellow bollard to be resited
  - Proposed 1 no. plain yellow bollard
  - Extg. railings to be removed
  - Proposed type II railings at junction
- Remark : Exact location / dimension to be determined on site

- To be implemented by EMSD
- Extg. 3 nos. turn left vehicular signal aspect to be removed and converted into 3 nos. full green vehicular signal aspect
  - Extg. 2 nos. ahead only filter vehicular signal aspect to be removed and extg. 1 no. turn right vehicular signal aspect to be resited
  - Proposed 1 no. primary and 1 no. secondary ahead only vehicular signal aspects

DRAWING NO.: W130637.005  
 SCALE 1:500 in A3  
 Ref. No.: W06P17A

**TRAFFIC ENGINEERING (NTW) DIVISION**



# **APPENDIX E**

## **Calculation Details of Junction Assessment**

# 2021 Existing Junction Calculations

## TRAFFIC SIGNALS CALCULATION

Job No.: **CHK50637810**

MVA HONG KONG LIMITED

Junction: Hung Tin Road / Hung Chi Road

Design Year: 2021

Description: Existing Weekday AM/PM Peak

Designed By: HWL

Checked By: TKM

Approach	Movements	Phase	Stage	Width (m)	Radius (m)		Gradient (%)	Pro. Turning (%)		Revised Saturation Flow (pcu/hr)		AM Peak			PM Peak		
					Left	Right		AM	PM	AM	PM	Flow (pcu/hr)	y Value	Critical y	Flow (pcu/hr)	y Value	Critical y
Hung Tin Road NB	↑	G	4	3.400	12.5			98%	100%	1750	1745	372	0.213		455	0.261	0.261
	↑	G	4	3.400		12.5		52%	54%	1975	1970	420	0.213		507	0.257	
	↑	G	4	3.400		10				1820	1820	388	0.213		468	0.257	
Hung Chi Road EB	→	H	1	3.500	12.5			49%	100%	1855	1755	153	0.082		100	0.057	
	→	H	1	3.500						2105	2105	174	0.083	0.083	120	0.057	0.057
	→	H	1	3.500						2105	2105	173	0.082		120	0.057	
Shek Po East Rd SB	↓	I	3	4.500	12.5					1845	1845	60	0.033		40	0.022	
HSK Interchange EB	→	A	1,4	3.400						1955	1955	165	0.084		150	0.077	
	↘	B	4	3.400		20				1950	1950	468	0.240	0.240	438	0.225	
	↘	B	4	3.400		15				1905	1905	457	0.240		427	0.224	
HSK Interchange WB	←	F	2	3.500		15				1915	1915	20	0.010		45	0.023	
	←	E	1,2	3.300						1945	1945	185	0.095		150	0.077	
Hung Tin Road SB	↓	C	4	3.400	10			14%	7%	1915	1935	220	0.115	0.115	144	0.074	
	↓	C	4	3.400						2095	2095	240	0.115		156	0.074	0.074
	↓	C	4	3.400		17.5				1930	1930	165	0.085		135	0.070	
Hung Chi Road WB	←	D	1	3.500						2105	2105	45	0.021		60	0.029	
	↙	D	1	3.500	10					1710	1710	55	0.032		90	0.053	
Pedestrian Crossing	Jp	3,4	MIN GREEN + FLASH =		7	+	10	=	17								
	Kp	3	MIN GREEN + FLASH =		6	+	6	=	12								
	Lp	2,3,4	MIN GREEN + FLASH =		6	+	6	=	12								
	Mp	3	MIN GREEN + FLASH =		7	+	9	=	16								
	Np	1,2,3	MIN GREEN + FLASH =		7	+	10	=	17								
	Op	3	MIN GREEN + FLASH =		6	+	6	=	12								
	Pp	2,3,4	MIN GREEN + FLASH =		7	+	9	=	16								

Notes:	Traffic Flow (pcu/hr)	Group	H.C.I,B	H.C.Mp,B	Group	H.C.Mp,B	H.C.I,G
		<b>y</b>	0.470	0.438	<b>y</b>	0.356	0.392
		<b>L (sec)</b>	21	35	<b>L (sec)</b>	35	28
		<b>C (sec)</b>	120	120	<b>C (sec)</b>	120	120
		<b>y pract.</b>	0.743	0.638	<b>y pract.</b>	0.638	0.690
		<b>R.C. (%)</b>	58%	46%	<b>R.C. (%)</b>	79%	76%

Stage / Phase Diagrams							
1.	2.	3.	4.	5.			
I/G= 7	I/G= 6	I/G= 6	I/G= 3	I/G=			
I/G= 7	I/G= 6	I/G= 6	I/G= 7	I/G=			

Date: **APR, 2022** Junction: **Hung Tin Road / Hung Chi Road** (J1)

**TRAFFIC SIGNALS CALCULATION**

Job No.: **CHK50637810**

**MVA HONG KONG LIMITED**

Junction: Castle Peak Road - Hung Shui Kiu / Hung Tak Road

Design Year: 2021

Description: Existing Weekday AM/ PM Peak

Designed By: HWL

Checked By: TKM

Approach	Movements	Phase	Stage	Width (m)	Radius (m)		Gradient (%)	Pro. Turning (%)		Revised Saturation Flow (pcu/hr)		AM Peak			PM Peak		
					Left	Right		AM	PM	AM	PM	Flow (pcu/hr)	y Value	Critical y	Flow (pcu/hr)	y Value	Critical y
Castle Peak Rd	↙	C	2	3.300	15					1770	1770	300	0.169		290	0.164	
Hung Shui Kiu	←	D	1	3.300						2085	2085	388	0.186	0.186	275	0.132	
WB	←	D	1	3.300						2085	2085	387	0.186		275	0.132	
Hung Tak Road NB	↗	B	2	4.000	10	15		6% / 94%	7% / 93%	1825	1825	410	0.225	0.225	275	0.151	0.151
Castle Peak Rd	* →	A	1	3.300						1750	1750	210	0.120		278	0.159	0.159
Hung Shui Kiu	→	A	1	3.300						2085	2085	250	0.120		331	0.159	
EB	→	A	1	3.300						2085	2085	250	0.120		331	0.159	
Pedestrian Crossing		Ep	1,3	MIN GREEN + FLASH =		5	+	7	=	12							
		Fp	1,3	MIN GREEN + FLASH =		5	+	6	=	11							
		Gp	3	MIN GREEN + FLASH =		10	+	8	=	18				*			*

<b>Notes:</b> * Site factor = 0.9 is used (Effect of bus stop situated at Castle Peak Road - Hung Shui Kiu EB)	<b>Flow: (pcu/hr)</b> 			<b>Group</b>	A,B,Gp	D,B,Gp	<b>Group</b>	A,C,Gp	A,B,Gp
	<b>y</b>	0.345	0.411	<b>y</b>	0.323	0.310			
	<b>L (sec)</b>	31	30	<b>L (sec)</b>	28	31			
	<b>C (sec)</b>	90	90	<b>C (sec)</b>	90	90			
	<b>y pract.</b>	0.590	0.600	<b>y pract.</b>	0.620	0.590			
	<b>R.C. (%)</b>	71%	46%	<b>R.C. (%)</b>	92%	91%			

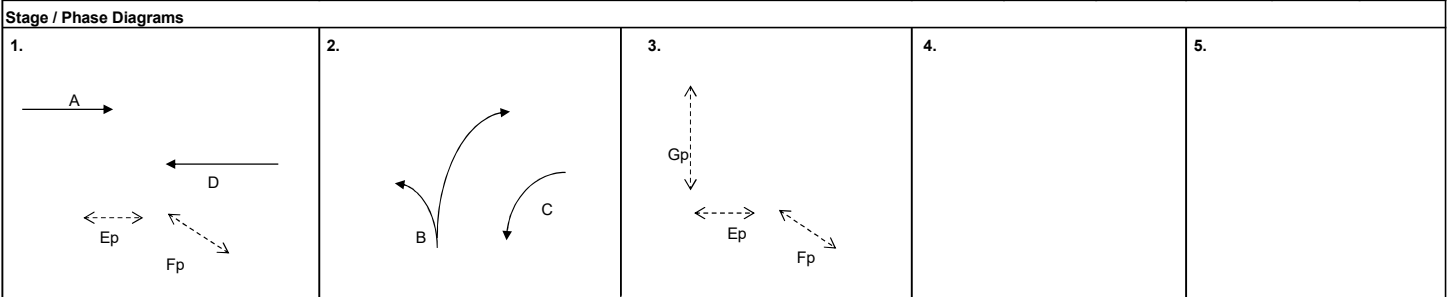

I/G= 2		I/G= 5		I/G= 7	18	I/G=		I/G=	
I/G= 3		I/G= 5		I/G= 7	18	I/G=		I/G=	
<b>Date:</b> APR, 2022								<b>Junction:</b>	



**TRAFFIC SIGNALS CALCULATION**

Job No.: CHK50637810

MVA HONG KONG LIMITED

Junction: Castle Peak Road - Hung Shui Kiu/ Tan Kwai Tsuen Road

Design Year: 2021

Description: Existing Weekday AM/ PM Peak

Designed By: HWL

Checked By: TKM

Approach	Movements	Phase	Stage	Width (m)	Radius (m)		Gradient (%)	Pro. Turning (%)		Revised Saturation Flow (pcu/hr)		AM Peak			PM Peak		
					Left	Right		AM	PM	AM	PM	Flow (pcu/hr)	y Value	Critical y	Flow (pcu/hr)	y Value	Critical y
Castle Peak Rd Hung Shui Kiu WB	→	B	2	3.300		30				1985	1985	245	0.123	0.123	125	0.063	0.063
Castle Peak Rd Hung Shui Kiu EB	←	C	1	3.650						1980	1980	386	0.195	0.195	275	0.139	0.139
Tan Kwai Tsuen Road NB	←	C	1	3.650						2120	2120	414	0.195	0.195	295	0.139	0.139
Castle Peak Rd Hung Shui Kiu WB (free-flow)	↖	D	3	4.000	15					1830	1830	195	0.107	0.107	190	0.104	0.104
Castle Peak Rd Hung Shui Kiu WB (free-flow)	→	A	1,2,3	3.300						2085	2085	355	0.170		470	0.225	
Castle Peak Rd Hung Shui Kiu WB (free-flow)	→	A	1,2,3	3.300						2085	2085	355	0.170		470	0.225	
Pedestrian Crossing		Ep	1	MIN GREEN + FLASH =			10	+	7	=	17						

<b>Notes:</b>	<b>Flow: (pcu/hr)</b>			<b>Group</b>	Ep,B,D	C,B,D	<b>Group</b>	Ep,B,D	C,B,D
	<b>y</b>	0.230		0.425	<b>y</b>	0.167	0.306		
	<b>L (sec)</b>	34		20	<b>L (sec)</b>	34	20		
	<b>C (sec)</b>	90		90	<b>C (sec)</b>	90	90		
	<b>y pract.</b>	0.560		0.700	<b>y pract.</b>	0.560	0.700		
	<b>R.C. (%)</b>	143%		65%	<b>R.C. (%)</b>	236%	129%		

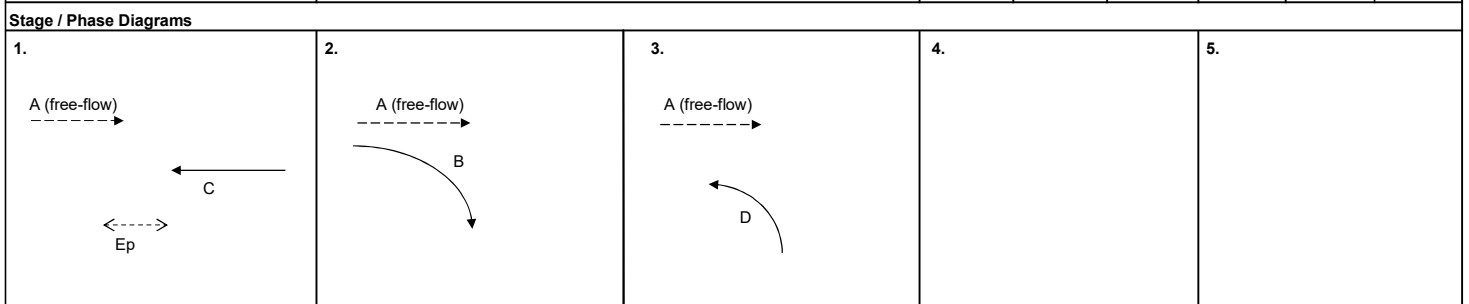

I/G= 6	I/G= 8	I/G= 9	I/G=	I/G=
I/G= 6	I/G= 8	I/G= 9	I/G=	I/G=
<b>Date:</b> APR, 2022			<b>Junction:</b> Castle Peak Road / Tan Kwai Tsuen Road (MN37)	

## Priority Junction Capacity Calculation

Job Title: CE 92/2017 (CE) Site Formation and Infrastructure Works for Development near Tan Kwai Tsuen, Yuen Long - IDC		Designed by: HWL
Junction: Tan Kwai Tsuen Road - Hung Shun Road (J4)		Checked by: TKM
Scheme: Existing Weekday AM/ PM Peak		Date: Apr-22
Design Year: 2021	Job No.: CHK50637810	
Arm A: Tan Kwai Tsuen Road (SB)		
Arm B: Hung Shun Road		
Arm C: Tan Kwai Tsuen Road (NB)		

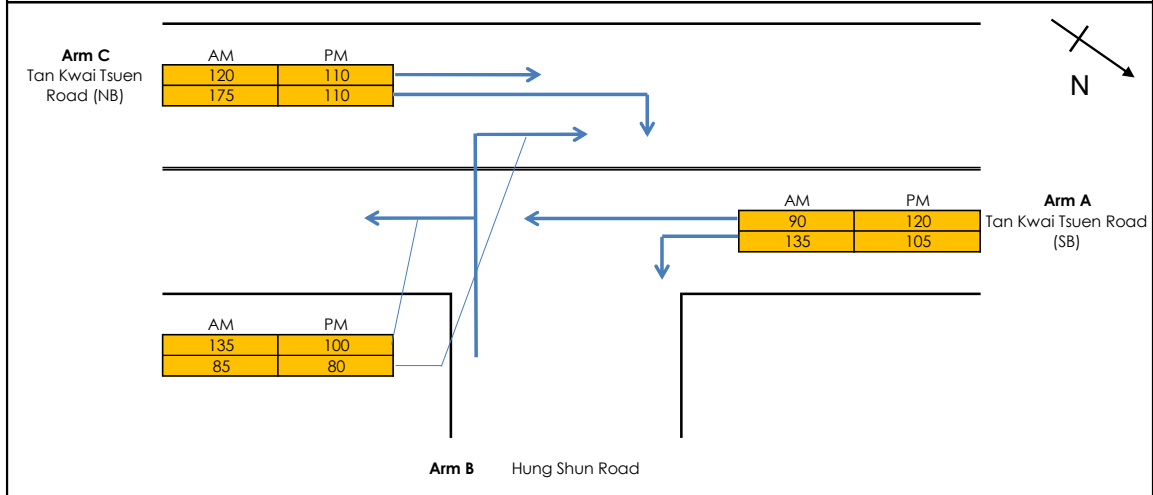

### GEOMETRY

Major Road Width (m)	W	8.00	Lane widths (m)	w(b-a)	3.50
Central Reserve Width (m)	Wcr	0.00		w(b-c)	3.50
Blockage of major road right turn	Y/N?	Y		w(c-b)	3.50
Combined stream on minor arm	Y/N?	Y			
Visibility Distances (m)	Vr(b-a)	60	Calculated Parameters	D	0.863
	VI(b-a)	25		E	0.942
	Vr(b-c)	70		F	0.968
	Vr(c-b)	100		Y	0.724

### ANALYSIS

		AM	PM
TRAFFIC FLOWS (pcu/hr)	q(c-a)	120	110
	q(c-b)	175	110
	q(a-b)	135	105
	q(a-c)	90	120
	q(b-a)	85	80
	q(b-c)	135	100
	f	0.61	0.56
CAPACITIES (pcu/hr)	Q(b-ac)	552	549
	Q(c-a)	1325.51	1502
	Q(c-b)	664	664
RFC's	c-a	0.09	0.07
	c-b	0.26	0.17
	b-ac	0.40	0.33
<b>RFC</b>		<b>0.40</b>	<b>0.33</b>

Where VI and Vr are visibility distances to the left or right of the respective streams  
 $D = (1 + 0.094(w(b-a) - 3.65))(1 + 0.0009(Vr(b-a) - 120))(1 + 0.0006(VI(b-a) - 150))$   
 $E = (1 + 0.094(w(b-c) - 3.65))(1 + 0.0009(Vr(b-c) - 120))$   
 $F = (1 + 0.094(w(c-b) - 3.65))(1 + 0.0009(Vr(c-b) - 120))$   
 $Y = 1 - 0.0345W$   
 f = proportion of minor traffic turning left  
 $Q(b-ac) = Q(b-c) * Q(b-a) / (1 - f) * Q(b-c) + f * Q(b-a)$  Capacity of combined streams

All the above formulas are in accordance to T.P.D.M. V.2.4 Appendix 1

**TRAFFIC SIGNALS CALCULATION**

Job No.: CHK50637810

MVA HONG KONG LIMITED

Junction: Castle Peak Road - Hung Shui Kiu / Shun Tat Street

Design Year: 2021

Description: Existing Weekday AM/ PM Peak

Designed By: HWL

Checked By: TKM

Approach	Movements	Phase	Stage	Width (m)	Radius (m)		Gradient (%)	Pro. Turning (%)		Revised Saturation Flow (pcu/hr)		AM Peak			PM Peak		
					Left	Right		AM	PM	AM	PM	Flow (pcu/hr)	y Value	Critical y	Flow (pcu/hr)	y Value	Critical y
Castle Peak Rd	→	F	1,2,3	3.500						1965	1965	642	0.327		756	0.385	
Hung Shui Kiu	→	F	1,2,3	3.500						2105	2105	688	0.327		809	0.384	
EB	↓	C	2	3.000		20				1910	1910	110	0.058	0.058	115	0.060	0.060
Castle Peak Rd	↔	A	3	3.800	15			24%	20%	1950	1955	465	0.238		492	0.252	
Hung Shui Kiu	←	A	3	3.800						2135	2135	510	0.239	0.239	538	0.252	0.252
WB	↔																
Shun Tat Street	↕	B	1	4.000	15	22.5		100% / 0%	100% / 0%	1830	1830	220	0.120	0.120	190	0.104	0.104
NB																	
Pedestrian Crossing		Dp	1	MIN GREEN + FLASH =		7	+	10	=	17							
		Ep	2,3	MIN GREEN + FLASH =		6	+	6	=	12							

Notes:	Flow: (pcu/hr)	Group	Dp,C,A	B,C,A	Group	Dp,C,A	B,C,A
		<b>y</b>	0.296	0.417	<b>y</b>	0.312	0.416
		<b>L (sec)</b>	32	14	<b>L (sec)</b>	32	14
		<b>C (sec)</b>	120	120	<b>C (sec)</b>	120	120
		<b>y pract.</b>	0.660	0.795	<b>y pract.</b>	0.660	0.795
		<b>R.C. (%)</b>	123%	91%	<b>R.C. (%)</b>	111%	91%

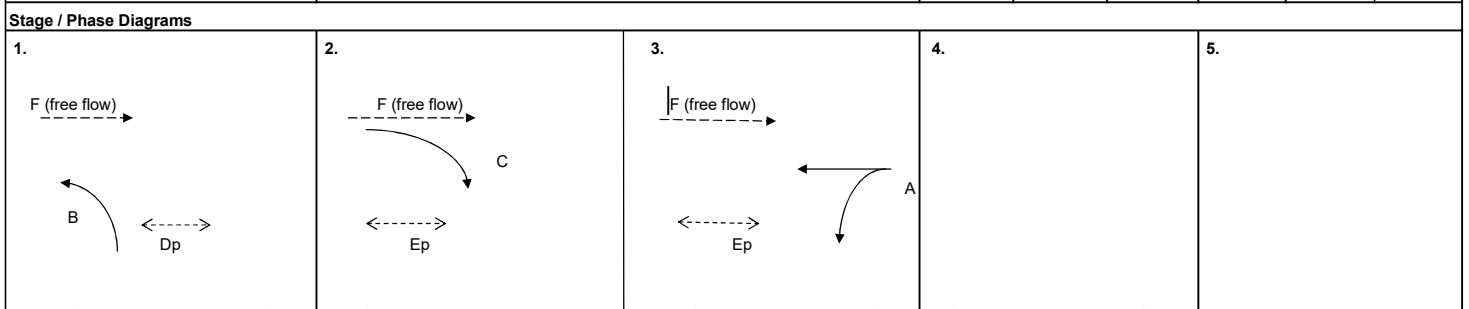

I/G= 6	I/G= 5	I/G= 6	I/G=	I/G=
I/G= 6	I/G= 5	I/G= 6	I/G=	I/G=
<b>Date:</b> APR, 2022			<b>Junction:</b> (J5) Castle Peak Road - Hung Shui Kiu / Shun Tat Street	

# Priority Junction Capacity Calculation



Job Title: CE 92/2017 (CE) Site Formation and Infrastructure Works for Development near Tan Kwai Tsuen, Yuen Long - IDC	Designed by: HWL
Junction: Shun Tat Street - Tat Fuk Road (J6)	Checked by: TKM
Scheme: Existing Weekday AM/ PM Peak	Date: Apr-22
Design Year: 2021	Job No.: CHK50637810
Arm A: Shun Tat Street (WB)	
Arm B: Tat Fuk Road (NB)	
Arm C: Shun Tat Street (EB)	
Arm D: Tat Fuk Road (SB)	

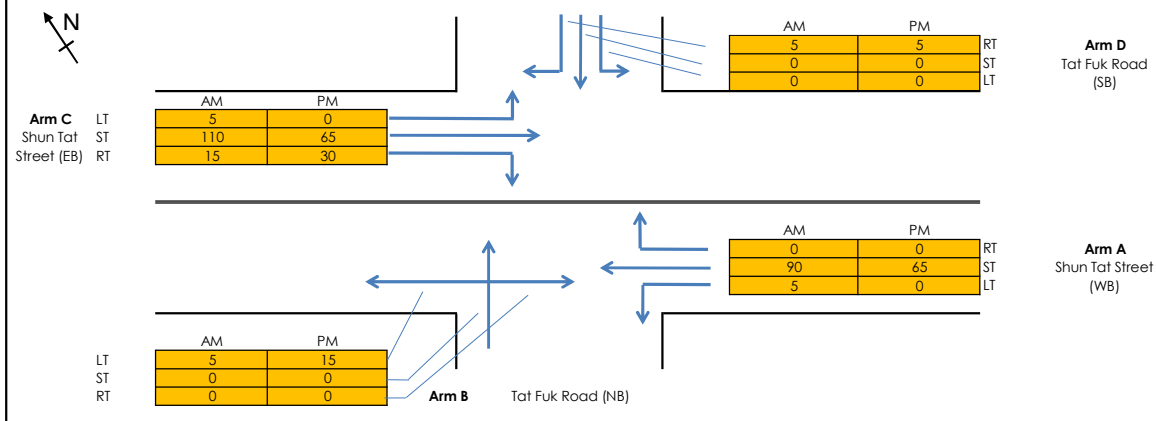

## GEOMETRY

Major Road Width (m)	W	10.00
Central Reserve Width (m)	Wcr	0.00

PARAMETER				Arm B				Arm D					
Lane widths (m)	w(b-a)	3.00	Blockage of major road RT (c-b block c-a)?	Y	w(d-c)	3.00	Blockage of major road RT (a-d block a-c)?	Y					
	w(b-c)	3.00				w(d-a)			3.00				
	w(c-b)	4.50				w(a-d)			4.50				
Visibility Distances (m)	Vr(b-a)	30	Calculated Parameters	D	E	120	Calculated Parameters	D	E				
	VI(b-a)	120								0.880	20	0.939	
	Vr(b-c)	50								F	1.060	F	1.022
	Vr(c-b)	100								Y	0.655	Y	0.655
Straight ahead movement using left lane?		Y			Straight ahead movement using left lane?		Y						

## ANALYSIS

		AM Peak		PM Peak				AM Peak		PM Peak	
TRAFFIC FLOWS (pcu/hr)	q(a-b)	5	0	q(c-d)	5	0	TRAFFIC FLOWS (pcu/hr)	q(c-d)	5	0	
	q(a-c)	90	65	q(c-a)	110	65		q(c-a)	110	65	
	q(a-d)	0	0	q(c-b)	15	30		q(c-b)	15	30	
	q(c-a)	110	65	q(c-c)	0	0		q(a-c)	90	65	
	q(c-b)	15	30	q(c-d)	5	0		q(a-d)	0	0	
	q(c-d)	5	0	q(d-a)	0	0		q(a-b)	5	0	
	q(d-a)	0	0	q(d-b)	0	0		q(b-c)	5	15	
	q(d-b)	0	0	q(d-c)	5	5		q(b-d)	0	0	
	q(d-c)	5	5	q(b-a)	0	0		q(b-a)	0	0	
	q(b-a)	0	0	q(b-c)	0	0		q(d-c)	5	5	
q(b-b)	0	0	q(b-d)	0	0	q(d-b)	0	0			
q(b-c)	5	15	q(b-c)	5	15	q(d-a)	0	0			
Left turn proportion	F	1.00	1.00	Left turn proportion	F	0.00	0.00				

		AM Peak		PM Peak				AM Peak		PM Peak	
CAPACITIES (pcu/hr)	Q(b-ad)	499	506	Q(d-bc)	504	513	CAPACITIES (pcu/hr)	Q(d-bc)	504	513	
	Q(b-acd)	636	642	Q(d-abc)	504	513		Q(d-abc)	504	513	
	Q(c-b)	766	774	Q(a-d)	728	735		Q(a-d)	728	735	
	Q(c-a)	1765	1730	Q(a-c)	1800	1800		Q(a-c)	1800	1800	

		AM Peak		PM Peak				AM Peak		PM Peak	
RFC's	c-b	0.02	0.04	a-d	0.00	0.00	RFC's	a-d	0.00	0.00	
	c-a	0.06	0.04	a-c	0.05	0.04		a-c	0.05	0.04	
	b-acd	0.01	0.02	d-acd	0.01	0.01		d-acd	0.01	0.01	

**RFC** **0.06** **0.04** **0.05** **0.04**

Where VI and Vr are visibility distances to the left or right of the respective streams  
 $D = (1 + 0.094(w(b-a) - 3.65)) (1 + 0.0009(Vr(b-a) - 120)) (1 + 0.0006(VI(b-a) - 150))$   
 $E = (1 + 0.094(w(b-c) - 3.65)) (1 + 0.0009(Vr(b-c) - 120))$   
 $F = (1 + 0.094(w(c-b) - 3.65)) (1 + 0.0009(Vr(c-b) - 120))$   
 $Y = 1 - 0.0345W$   
 F = proportion of minor traffic turning left  
 $Q(b-ad) = Q(b-a) * Q(b-d) / (0.5 * Q(b-a) + 0.5 * Q(b-d))$  Capacity of combined streams  
 $Q(b-acd) = Q(b-c) * Q(b-ad) / ((1-F) * Q(b-c) + F * Q(b-ad))$  Capacity of combined streams

All the above formulas are in accordance to T.P.D.M. Vol.2 Chapter 4 Appendix 1

# Priority Junction Capacity Calculation



Job Title: CE 92/2017 (CE) Site Formation and Infrastructure Works for Development near Tan Kwai Tsuen, Yuen Long - IDC		Designed by: HWL
Junction: Shun Tat Street - Tung Fuk Road (J7)		Checked by: TKM
Scheme: Existing Weekday AM/ PM Peak		Date: Apr-22
Design Year: 2021	Job No.: CHK50637810	
Arm A: Local Road (WB)		
Arm B: Tung Fuk Road (NB)		
Arm C: Shun Tat Street (EB)		
Arm D: Refuse Transfer Station		

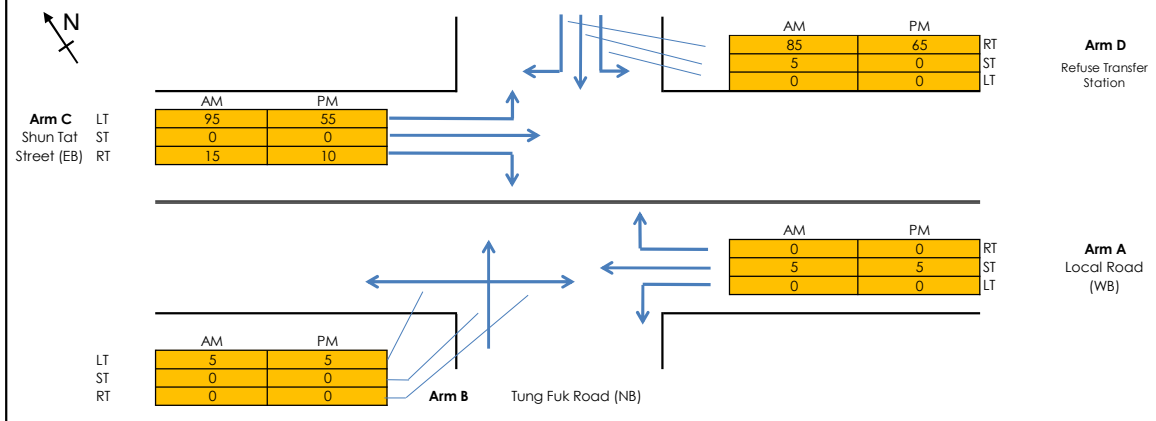

## GEOMETRY

Major Road Width (m)	W	10.00
Central Reserve Width (m)	Wcr	0.00

PARAMETER		Arm B		Arm D					
Lane widths (m)	w(b-a)	3.00	Blockage of major road RT (c-b block c-a)?	w(d-c)	3.00				
	w(b-c)	3.00		w(d-a)	3.00				
	w(c-b)	4.50		w(a-d)	4.50				
Visibility Distances (m)	Vr(b-a)	30	Calculated Parameters	D	0.847				
	VI(b-a)	120				E	0.880		
	Vr(b-c)	50						F	1.060
	Vr(c-b)	100							
Straight ahead movement using left lane?		Y	Straight ahead movement using left lane?		Y				

## ANALYSIS

		AM Peak		PM Peak			
TRAFFIC FLOWS (pcu/hr)	q(a-b)	0	0	q(c-d)	95		
	q(a-c)	5	5	q(c-a)	0		
	q(a-d)	0	0	q(c-b)	15		
	q(c-a)	0	0	q(a-c)	5		
	q(c-b)	15	10	q(a-d)	0		
	q(c-d)	95	55	q(a-b)	0		
	q(d-a)	0	0	q(b-c)	5		
	q(d-b)	5	0	q(b-d)	0		
	q(d-c)	85	65	q(b-a)	0		
	q(b-a)	0	0	q(d-c)	85		
q(b-d)	0	0	q(d-b)	5			
q(b-c)	5	5	q(d-a)	0			
Left turn proportion	F	1.00	1.00	Left turn proportion	F	0.00	0.00

		AM Peak		PM Peak	
CAPACITIES (pcu/hr)	Q(b-ad)	520	526	Q(d-bc)	531
	Q(b-acd)	654	654	Q(d-abc)	531
	Q(c-b)	789	789	Q(a-d)	733
	Q(c-a)	1766	1777	Q(a-c)	1800

RFC's		AM Peak		PM Peak	
c-b	0.02	0.01	a-d	0.00	0.00
c-a	0.00	0.00	a-c	0.00	0.00
b-acd	0.01	0.01	d-acd	0.17	0.12

<b>RFC</b>	<b>0.02</b>	<b>0.01</b>	<b>0.17</b>	<b>0.12</b>
------------	-------------	-------------	-------------	-------------

Where VI and Vr are visibility distances to the left or right of the respective streams  
 $D = (1 + 0.094(w(b-a) - 3.65)) (1 + 0.0009(Vr(b-a) - 120)) (1 + 0.0006(VI(b-a) - 150))$   
 $E = (1 + 0.094(w(b-c) - 3.65)) (1 + 0.0009(Vr(b-c) - 120))$   
 $F = (1 + 0.094(w(c-b) - 3.65)) (1 + 0.0009(Vr(c-b) - 120))$   
 $Y = 1 - 0.0345W$   
 F = proportion of minor traffic turning left  
 $Q(b-ad) = Q(b-a) * Q(b-d) / (0.5 * Q(b-a) + 0.5 * Q(b-d))$  Capacity of combined streams  
 $Q(b-acd) = Q(b-c) * Q(b-ad) / ((1-F) * Q(b-c) + F * Q(b-ad))$  Capacity of combined streams

All the above formulas are in accordance to T.P.D.M. Vol.2 Chapter 4 Appendix 1

**TRAFFIC SIGNALS CALCULATION**

Job No.: **CHK50637810**

**MVA HONG KONG LIMITED**

Junction: Castle Peak Road - Hung Shui Kiu / Fuk Hang Tsuen Road

Design Year: 2021

Description: Existing Weekday AM/PM Peak

Designed By: HWL

Checked By: TKM

Approach	Movements	Phase	Stage	Width (m)	Radius (m)		Gradient (%)	Pro. Turning (%)		Revised Saturation Flow (pcu/hr)		AM Peak			PM Peak		
					Left	Right		AM	PM	AM	PM	Flow (pcu/hr)	y Value	Critical y	Flow (pcu/hr)	y Value	Critical y
Castle Peak Rd	→	E	1	3.250						2080	2080	688	0.331	0.331	833	0.400	0.400
Hung Shui Kiu	→	E	1	3.250						2080	2080	687	0.330		832	0.400	
EB	↓	P	2	3.000		15				1740	1740	185	0.106		225	0.129	
Castle Peak Rd	←	F	1	3.750						2130	2130	620	0.291		600	0.282	
Hung Shui Kiu	←	F	1	3.750						2130	2130	620	0.291		600	0.282	
WB	↖	F	1	3.750	15					1810	1810	60	0.033		60	0.033	
Fuk Hang Tsuen Road (NB)	↗	K	3	3.300	12.5	10		79% / 21%	78% / 22%	1725	1725	335	0.194	0.194	275	0.159	0.159
Pedestrian Crossing		Hp	2	MIN GREEN + FLASH =		10	+	10	=	20				*			*
		Gp	2,3	MIN GREEN + FLASH =		10	+	10	=	20							

Notes:	Flow: (pcu/hr)	Group	E,P,K	E,Hp,K	Group	E,P,K	E,Hp,K
		<b>y</b>	0.631	0.525	<b>y</b>	0.689	0.560
		<b>L (sec)</b>	15	34	<b>L (sec)</b>	15	34
		<b>C (sec)</b>	100	100	<b>C (sec)</b>	100	100
		<b>y pract.</b>	0.765	0.594	<b>y pract.</b>	0.765	0.594
		<b>R.C. (%)</b>	21%	13%	<b>R.C. (%)</b>	11%	6%

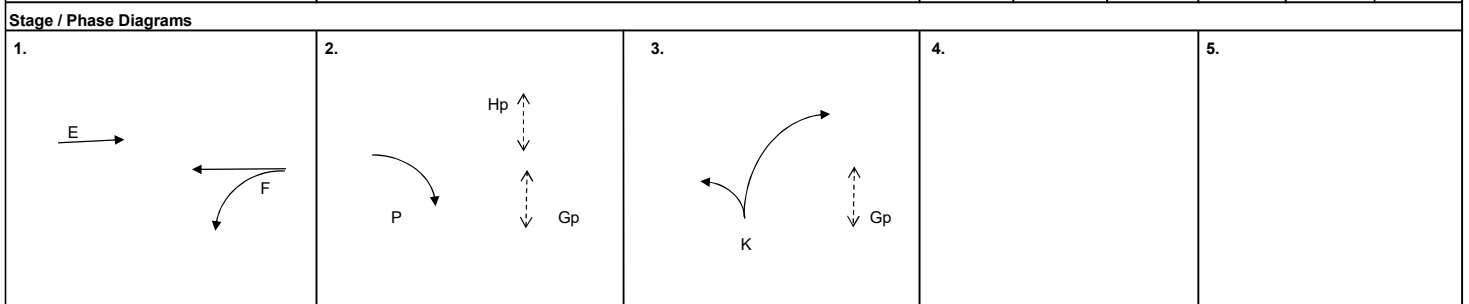

I/G= 7		I/G= 7	20	I/G= 2		I/G=		I/G=	
I/G= 7		I/G= 7	20	I/G= 2		I/G=		I/G=	
<b>Date:</b> APR, 2022								<b>Junction:</b> Castle Peak Road - Hung Shui Kiu / Fuk Hang Tsuen Road	

(J8)

**TRAFFIC SIGNALS CALCULATION**

Job No.: **CHK50637810**

**MVA HONG KONG LIMITED**

Junction: Castle Peak Road - Hung Tin Road

Design Year: 2021

Description: Existing Weekday AM/ PM Peak

Designed By: HWL

Checked By: TKM

Approach	Movements	Phase	Stage	Width (m)	Radius (m)		Gradient (%)	Pro. Turning (%)		Revised Saturation Flow (pcu/hr)		AM Peak			PM Peak		
					Left	Right		AM	PM	AM	PM	Flow (pcu/hr)	y Value	Critical y	Flow (pcu/hr)	y Value	Critical y
Hung Tin Road SB	L	F	2	3.300	12.5					1735	1735	196	0.113		137	0.079	
	↕	F	2	3.500	15	15		9% / 91%	2% / 98%	1915	1915	216	0.113		150	0.078	
	↕	F	2	3.500		12.5				1880	1880	213	0.113	0.113	148	0.079	
Castle Peak Road	↖	C	2,3	3.300	22.5					1825	1825	270	0.148		370	0.203	0.203
Hung Shui Kiu	→	B	3,4	3.650						1980	1980	331	0.167	0.167	464	0.234	
EB	→	B	3,4	3.650						2120	2120	354	0.167		496	0.234	
Castle Peak Road	←	D	1,3,4	3.650						1980	1980	348	0.176		266	0.134	
Hung Shui Kiu	←	D	1,3,4	3.650						2120	2120	372	0.175		284	0.134	
WB	↖	E	1	3.400		15				1905	1905	350	0.184	0.184	360	0.189	0.189
LRT (FIXED TIME)		A	4	MIN GREEN + (FLASH + /			20	+	16	=	36						*
Pedestrian Crossing	Gp	1	MIN GREEN + FLASH =			5	+	9	=	14							
	Hp	1,2,3	MIN GREEN + FLASH =			5	+	8	=	13							
	lp	1,3,4	MIN GREEN + FLASH =			5	+	9	=	14							
	Jp	4	MIN GREEN + FLASH =			7	+	14	=	21							
	Kp	2	MIN GREEN + FLASH =			8	+	7	=	15							

Notes:	Flow: (pcu/hr)	Group	E,C,A	E,F,B	Group	E,F,B	E,C,A
		<b>y</b>	0.332	0.464	<b>y</b>	0.502	0.392
		<b>L (sec)</b>	51	20	<b>L (sec)</b>	12	49
		<b>C (sec)</b>	130	130	<b>C (sec)</b>	130	130
		<b>y pract.</b>	0.547	0.762	<b>y pract.</b>	0.817	0.561
		<b>R.C. (%)</b>	65%	64%	<b>R.C. (%)</b>	63%	43%

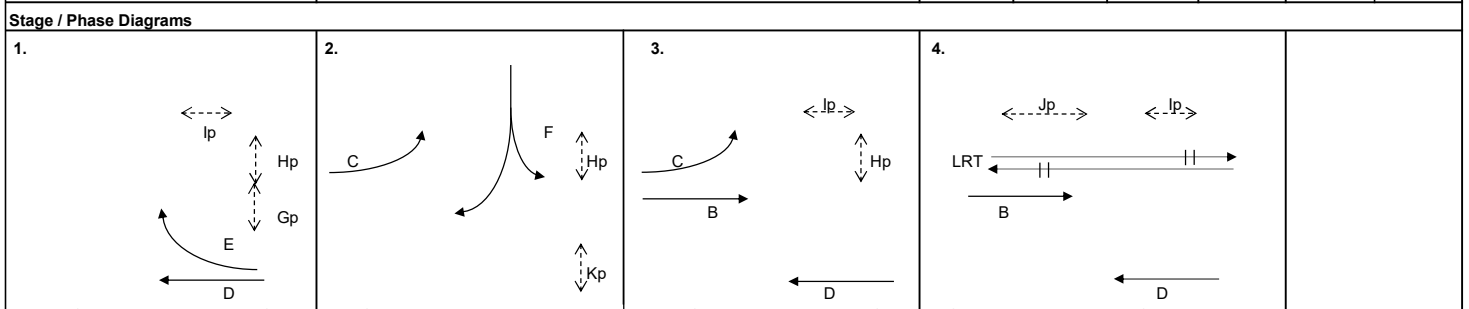

I/G= 8	I/G= 9	I/G= 6	I/G=	I/G=
I/G=	I/G= 9	I/G=	I/G= 6	I/G=
Date: APR, 2022			Junction: Castle Peak Road - Hung Tin Road	

## Priority Junction Capacity Calculation

Job Title: CE 92/2017 (CE) Site Formation and Infrastructure Works for Development near Tan Kwai Tsuen, Yuen Long - IDC	Designed by: HWL
Junction: Tan Kwai Tsuen Road - Shui Fu Road (J10)	Checked by: TKM
Scheme: Existing Weekday AM/ PM Peak	Date: Apr-22
Design Year: 2021	Job No.: CHK50637810
Arm A: Tan Kwai Tsuen Road (SB)	
Arm B: Shui Fu Road	
Arm C: Tan Kwai Tsuen Road (NB)	

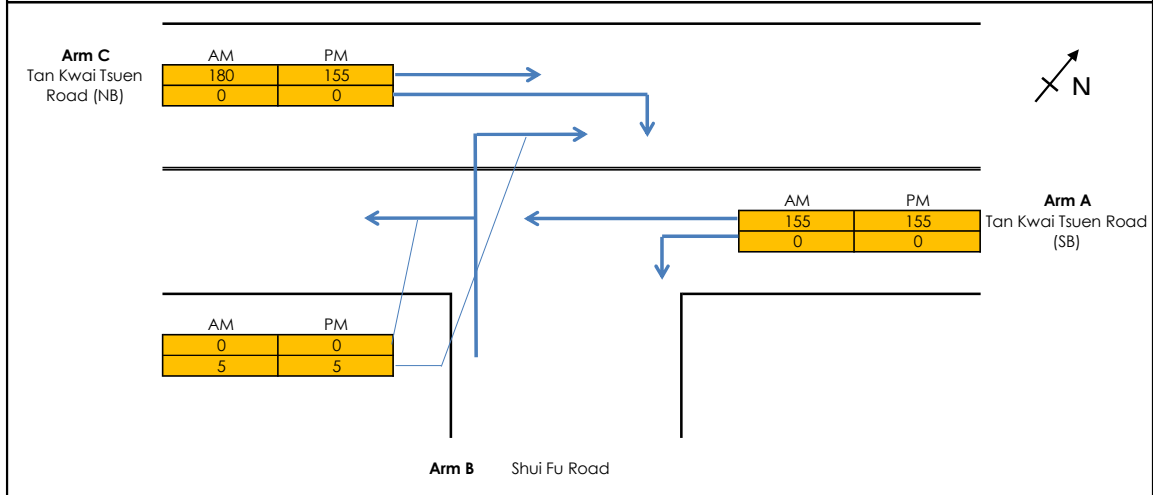

### GEOMETRY

Major Road Width (m)	W	7.25	Lane widths (m)	w(b-a)	3.00
Central Reserve Width (m)	Wcr	0.00		w(b-c)	3.00
Blockage of major road right turn	Y/N?	Y		w(c-b)	3.50
Combined stream on minor arm	Y/N?	Y			
Visibility Distances (m)	Vr(b-a)	80	Calculated Parameters	D	0.867
	VI(b-a)	80		E	0.905
	Vr(b-c)	80		F	0.933
	Vr(c-b)	60		Y	0.75

### ANALYSIS

		AM	PM
TRAFFIC FLOWS (pcu/hr)	q(c-a)	180	155
	q(c-b)	0	0
	q(a-b)	0	0
	q(a-c)	155	155
	q(b-a)	5	5
	q(b-c)	0	0
	f	0.00	0.00
CAPACITIES (pcu/hr)	Q(b-ac)	480	484
	Q(c-a)	1800	1800
	Q(c-b)	655	655
RFC's	c-a	0.10	0.09
	c-b	0.00	0.00
	b-ac	0.01	0.01
<b>RFC</b>		<b>0.10</b>	<b>0.09</b>

Where VI and Vr are visibility distances to the left or right of the respective streams

$$D = (1 + 0.094(w(b-a) - 3.65))(1 + 0.0009(Vr(b-a) - 120))(1 + 0.0006(VI(b-a) - 150))$$

$$E = (1 + 0.094(w(b-c) - 3.65))(1 + 0.0009(Vr(b-c) - 120))$$

$$F = (1 + 0.094(w(c-b) - 3.65))(1 + 0.0009(Vr(c-b) - 120))$$

$$Y = 1 - 0.0345W$$

f = proportion of minor traffic turning left

$$Q(b-ac) = Q(b-c) * Q(b-a) / (1 - f) * Q(b-c) + f * Q(b-a) \quad \text{Capacity of combined streams}$$

All the above formulas are in accordance to T.P.D.M. V.2.4 Appendix 1



# 2030 Reference Junction Calculations

## TRAFFIC SIGNALS CALCULATION

Job No.: **CHK50637810**

MVA HONG KONG LIMITED

Junction: Hung Tin Road / Hung Chi Road

Design Year: 2030

Description: Reference Weekday AM/ PM Peak

Designed By: HWL

Checked By: TKM

Approach	Movements	Phase	Stage	Width (m)	Radius (m)		Gradient (%)	Pro. Turning (%)		Revised Saturation Flow (pcu/hr)		AM Peak			PM Peak		
					Left	Right		AM	PM	AM	PM	Flow (pcu/hr)	y Value	Critical y	Flow (pcu/hr)	y Value	Critical y
Hung Tin Road NB	↕	G	4	3.400	12.5			96%	100%	1755	1745	626	0.357		627	0.359	0.359
	↕	G	4	3.400		12.5		64%	69%	1945	1935	694	0.357	0.357	695	0.359	
	↕	G	4	3.400		10				1820	1820	650	0.357		653	0.359	
Hung Chi Road EB	↔	H	1	3.500	12.5			63%	73%	1830	1805	64	0.035		41	0.023	
	↔	H	1	3.500						2105	2105	73	0.035		47	0.022	
	↔	H	1	3.500						2105	2105	73	0.035		47	0.022	
Shek Po East Rd SB	↕	I	3	4.500	12.5					1845	1845	70	0.038	0.038	50	0.027	
HSK Interchange EB	↔	A	1,4	3.400						1955	1955	175	0.090		150	0.077	
	↔	B	4	3.400		20				1950	1950	584	0.299		574	0.294	
	↔	B	4	3.400		15				1905	1905	571	0.300		561	0.294	
HSK Interchange WB	↔	F	2	3.500		15				1915	1915	30	0.016		40	0.021	
	↔	E	1,2	3.300						1945	1945	80	0.041		55	0.028	
Hung Tin Road SB	↕	C	4	3.400	10			16%	14%	1910	1915	153	0.080	0.080	107	0.056	0.056
	↕	C	4	3.400						2095	2095	167	0.080		118	0.056	
	↕	C	4	3.400		17.5				1930	1930	70	0.036		45	0.023	
Hung Chi Road WB	↔	D	1	3.500						2105	2105	40	0.019		50	0.024	
	↔	D	1	3.500	10					1710	1710	75	0.044	0.044	115	0.067	0.067
Pedestrian Crossing	Jp	3,4	MIN GREEN + FLASH =		7	+	10	=	17								
	Kp	3	MIN GREEN + FLASH =		6	+	6	=	12								
	Lp	2,3,4	MIN GREEN + FLASH =		6	+	6	=	12								
	Mp	3	MIN GREEN + FLASH =		7	+	9	=	16								
	Np	1,2,3	MIN GREEN + FLASH =		7	+	10	=	17								
	Op	3	MIN GREEN + FLASH =		6	+	6	=	12								
	Pp	2,3,4	MIN GREEN + FLASH =		7	+	9	=	16								

Notes:	Traffic Flow (pcu/hr)	Group	H.C.I,G	D.C.I,G	Group	H.C.I,G	D.C.I,G
		<b>y</b>	0.510	0.519	<b>y</b>	0.415	0.482
		<b>L (sec)</b>	22	21	<b>L (sec)</b>	34	27
		<b>C (sec)</b>	120	120	<b>C (sec)</b>	120	120
		<b>y pract.</b>	0.735	0.743	<b>y pract.</b>	0.645	0.698
		<b>R.C. (%)</b>	44%	43%	<b>R.C. (%)</b>	55%	45%

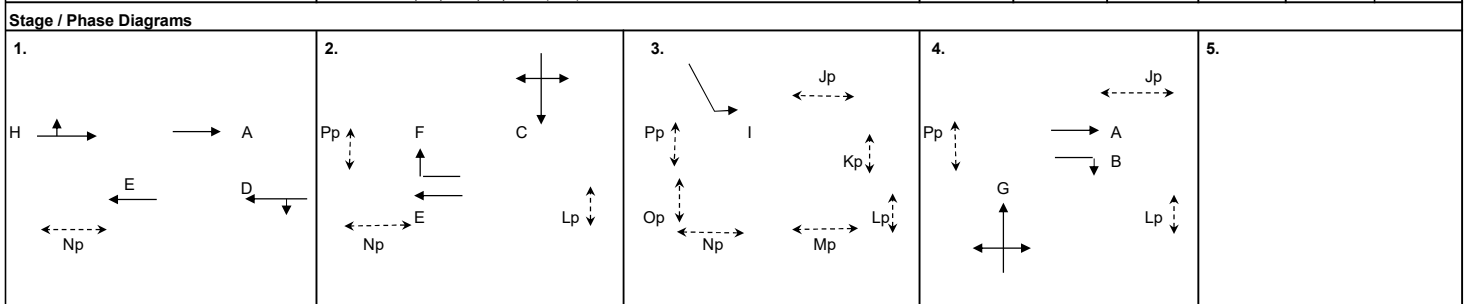

I/G= 6		I/G= 6		I/G= 6		I/G= 7		I/G=	
I/G= 6		I/G= 6		I/G= 6	5	I/G= 7		I/G=	
<b>Date:</b> APR, 2022							<b>Junction:</b> Hung Tin Road / Hung Chi Road		

**TRAFFIC SIGNALS CALCULATION**

Job No.: **CHK50637810**

**MVA HONG KONG LIMITED**

Junction: Castle Peak Road - Hung Shui Kiu / Hung Tak Road

Design Year: 2030

Description: Reference Weekday AM/ PM Peak (TD Improvement Scheme)

Designed By: HWL

Checked By: TKM

Approach	Movements	Phase	Stage	Width (m)	Radius (m)		Gradient (%)	Pro. Turning (%)		Revised Saturation Flow (pcu/hr)		AM Peak			PM Peak		
					Left	Right		AM	PM	AM	PM	Flow (pcu/hr)	y Value	Critical y	Flow (pcu/hr)	y Value	Critical y
Castle Peak Road - Hung Shui Kiu WB	↖	C	2	3.300	15					1770	1770	310	0.175		230	0.130	0.130
	←	D	1	3.300						2085	2085	345	0.165	0.165	295	0.141	0.141
	←	D	1	3.300						2085	2085	345	0.165		295	0.141	
Hung Tak Road NB	**↑*	B	2	3.500	10	15		16% / 84%	13% / 87%	1920	1920	340	0.177	0.177	190	0.099	
Castle Peak Road - Hung Shui Kiu EB	*→	A	1	3.300						1750	1750	155	0.089		213	0.122	
	→	A	1	3.300						2085	2085	185	0.089		253	0.121	
	→	A	1	3.300						2085	2085	185	0.089		254	0.122	
Pedestrian Crossing	Ep	1,3		MIN GREEN + FLASH =		5	+	7	=	12							
	Fp	1,3		MIN GREEN + FLASH =		5	+	6	=	11							
	Gp	3		MIN GREEN + FLASH =		10	+	8	=	18				*			*

<b>Notes:</b> * Site factor = 0.9 is used (Effect of bus stop situated at Castle Peak Road - Hung Shui Kiu EB)  ** Saturation flow at Hung Tak Road increased	<b>Flow: (pcu/hr)</b> 	<b>Group</b>	D,C,Gp	D,B,Gp	<b>Group</b>	A,C,Gp	D,C,Gp
		<b>y</b>	0.341	0.343	<b>y</b>	0.252	0.271
		<b>L (sec)</b>	27	30	<b>L (sec)</b>	28	27
		<b>C (sec)</b>	90	90	<b>C (sec)</b>	90	90
		<b>y pract.</b>	0.630	0.600	<b>y pract.</b>	0.620	0.630
		<b>R.C. (%)</b>	85%	75%	<b>R.C. (%)</b>	146%	132%

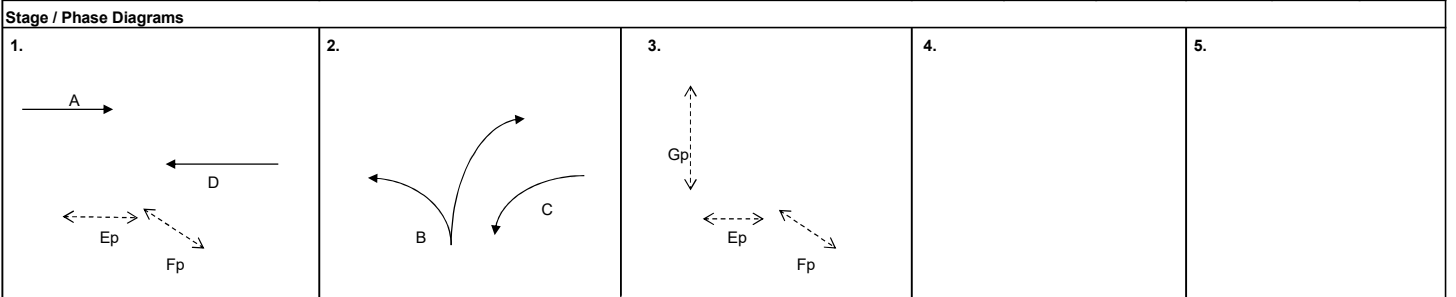

I/G= 2		I/G= 5		I/G= 7	18	I/G=		I/G=	
I/G= 2		I/G= 5		I/G= 4	18	I/G=		I/G=	
<b>Date:</b> APR, 2022								<b>Junction:</b> Castle Peak Road - Hung Shui Kiu / Hung Tak Road (J2)	

**TRAFFIC SIGNALS CALCULATION**

Job No.: CHK50637810

MVA HONG KONG LIMITED

Junction: Castle Peak Road - Hung Shui Kiu/ Tan Kwai Tsuen Road

Design Year: 2030

Description: Reference Weekday AM/ PM Peak (TD Improvement Scheme)

Designed By: HWL

Checked By: TKM

Approach	Movements	Phase	Stage	Width (m)	Radius (m)		Gradient (%)	Pro. Turning (%)		Revised Saturation Flow (pcu/hr)		AM Peak			PM Peak		
					Left	Right		AM	PM	AM	PM	Flow (pcu/hr)	y Value	Critical y	Flow (pcu/hr)	y Value	Critical y
Castle Peak Rd Hung Shui Kiu WB	→ → ↓	I I H	1,2 1,2 2	3,300 3,300 3,300						1945 2085 1985	1945 2085 1985	210 225 200	0.108 0.108 0.101	0.101	309 331 220	0.159 0.159 0.111	0.111
Castle Peak Rd Hung Shui Kiu EB	← ←	G G	1 1	3,650 3,650						1980 2120	1980 2120	360 385	0.182 0.182	0.182	297 318	0.150 0.150	0.150
Tan Kwai Tsuen Road NB	↑	F	3	4,000	15	17.5		72% / 28%	72% / 28%	1840	1840	325	0.177	0.177	290	0.158	0.158
Pedestrian Crossing		Jp	1	MIN GREEN + FLASH =		10	+	7	=	17							

<b>Notes:</b>	<b>Flow: (pcu/hr)</b>			<b>Group</b>	Jp,H,F	G,H,F	<b>Group</b>	Jp,H,F	G,H,F
		<b>y</b>	0.277	0.459	<b>y</b>	0.268	0.418		
		<b>L (sec)</b>	29	19	<b>L (sec)</b>	29	19		
		<b>C (sec)</b>	90	90	<b>C (sec)</b>	90	90		
		<b>y pract.</b>	0.610	0.710	<b>y pract.</b>	0.610	0.710		
		<b>R.C. (%)</b>	120%	55%	<b>R.C. (%)</b>	127%	70%		

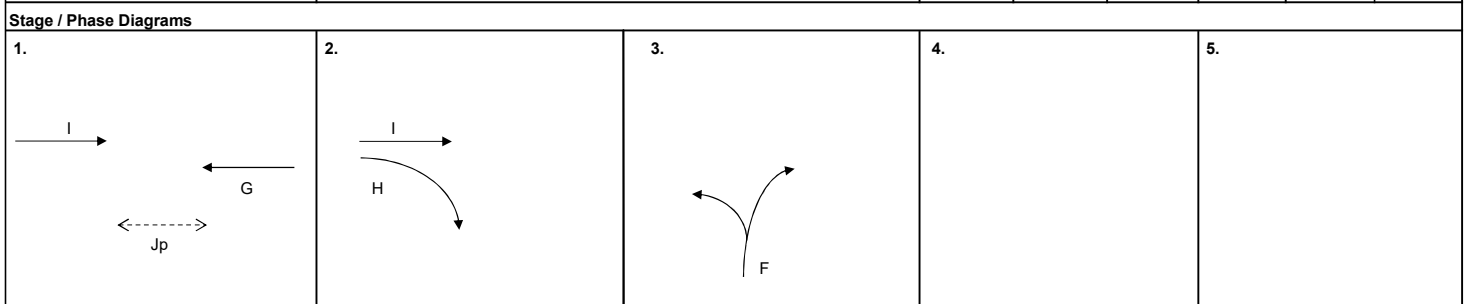

I/G= 6	I/G= 7	I/G= 9	I/G=	I/G=
I/G= 6	I/G= 7	I/G= 9	I/G=	I/G=
<b>Date:</b> APR, 2022			<b>Junction:</b> Castle Peak Road / Tan Kwai Tsuen Road (MN37)	

## Priority Junction Capacity Calculation

Job Title: CE 92/2017 (CE) Site Formation and Infrastructure Works for Development near Tan Kwai Tsuen, Yuen Long - IDC		Designed by: HWL
Junction: Tan Kwai Tsuen Road - Hung Shun Road (J4)		Checked by: TKM
Scheme: Reference Weekday AM/ PM Peak		Date: Apr-22
Design Year: 2030	Job No.: CHK50637810	
Arm A: Tan Kwai Tsuen Road (SB)		
Arm B: Hung Shun Road		
Arm C: Tan Kwai Tsuen Road (NB)		

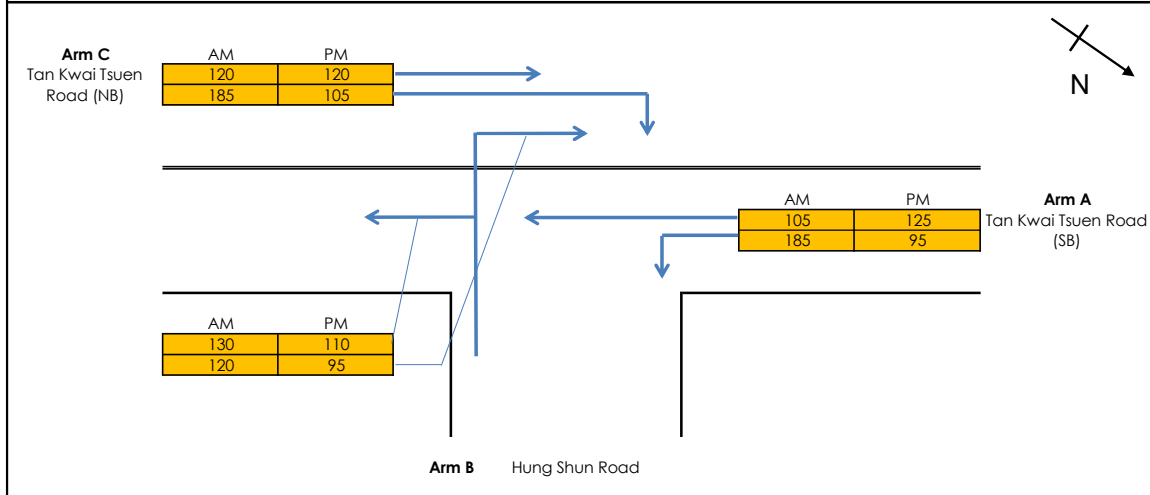

### GEOMETRY

Major Road Width (m)	W	8.00	Lane widths (m)	w(b-a)	3.50
Central Reserve Width (m)	Wcr	0.00		w(b-c)	3.50
Blockage of major road right turn	Y/N?	Y		w(c-b)	3.50
Combined stream on minor arm	Y/N?	Y			
Visibility Distances (m)	Vr(b-a)	60	Calculated Parameters	D	0.863
	VI(b-a)	25		E	0.942
	Vr(b-c)	70		F	0.968
	Vr(c-b)	100		Y	0.724

### ANALYSIS

		AM	PM
TRAFFIC FLOWS (pcu/hr)	q(c-a)	120	120
	q(c-b)	185	105
	q(a-b)	185	95
	q(a-c)	105	125
	q(b-a)	120	95
	q(b-c)	130	110
	f	0.52	0.54
CAPACITIES (pcu/hr)	Q(b-ac)	519	545
	Q(c-a)	1285.54	1516
	Q(c-b)	647	665
RFC's	c-a	0.09	0.08
	c-b	0.29	0.16
	b-ac	0.48	0.38
<b>RFC</b>		<b>0.48</b>	<b>0.38</b>

Where VI and Vr are visibility distances to the left or right of the respective streams  
 $D = (1 + 0.094(w(b-a) - 3.65))(1 + 0.0009(Vr(b-a) - 120))(1 + 0.0006(VI(b-a) - 150))$   
 $E = (1 + 0.094(w(b-c) - 3.65))(1 + 0.0009(Vr(b-c) - 120))$   
 $F = (1 + 0.094(w(c-b) - 3.65))(1 + 0.0009(Vr(c-b) - 120))$   
 $Y = 1 - 0.0345W$

f = proportion of minor traffic turning left  
 $Q(b-ac) = Q(b-c) * Q(b-a) / (1 - f) * Q(b-c) + f * Q(b-a)$  Capacity of combined streams

All the above formulas are in accordance to T.P.D.M. V.2.4 Appendix 1

**TRAFFIC SIGNALS CALCULATION**

Job No.: CHK50637810

MVA HONG KONG LIMITED

Junction: Castle Peak Road - Hung Shui Kiu / Shun Tat Street

Design Year: 2030

Description: Reference Weekday AM/ PM Peak (TD Improvement Scheme)

Designed By: HWL

Checked By: TKM

Approach	Movements	Phase	Stage	Width (m)	Radius (m)		Gradient (%)	Pro. Turning (%)		Revised Saturation Flow (pcu/hr)		AM Peak			PM Peak		
					Left	Right		AM	PM	AM	PM	Flow (pcu/hr)	y Value	Critical y	Flow (pcu/hr)	y Value	Critical y
Castle Peak Rd	→	F	1	3.500						2105	2105	559	0.266	0.266	577	0.274	0.274
Hung Shui Kiu EB	↕	C	1	3.500		20		20%	20%	2075	2075	551	0.266		568	0.274	
Castle Peak Road	↕	A	3	3.800	15			29%	23%	1940	1950	378	0.195		442	0.227	0.227
Hung Shui Kiu WB	←	A	3	3.800						2135	2135	417	0.195	0.195	483	0.226	
Shun Tat Street NB	↕	B	2	4.000	12.5	17.5		76% / 24%	74% / 26%	1815	1815	225	0.124	0.124	190	0.105	0.105
Pedestrian Crossing		Dp	2	MIN GREEN + FLASH =		7	+	10	=	17							
		Ep	1,3	MIN GREEN + FLASH =		6	+	6	=	12							

<b>Notes:</b>	<b>Flow: (pcu/hr)</b>		<b>Group</b>	C,Dp,A	F,B,A	<b>Group</b>	C,Dp,A	F,B,A
	<b>y</b>		0.461	0.585	<b>y</b>	0.500	0.605	
	<b>L (sec)</b>		30	14	<b>L (sec)</b>	30	14	
	<b>C (sec)</b>		120	120	<b>C (sec)</b>	120	120	
	<b>y pract.</b>		0.675	0.795	<b>y pract.</b>	0.675	0.795	
	<b>R.C. (%)</b>		46%	36%	<b>R.C. (%)</b>	35%	31%	

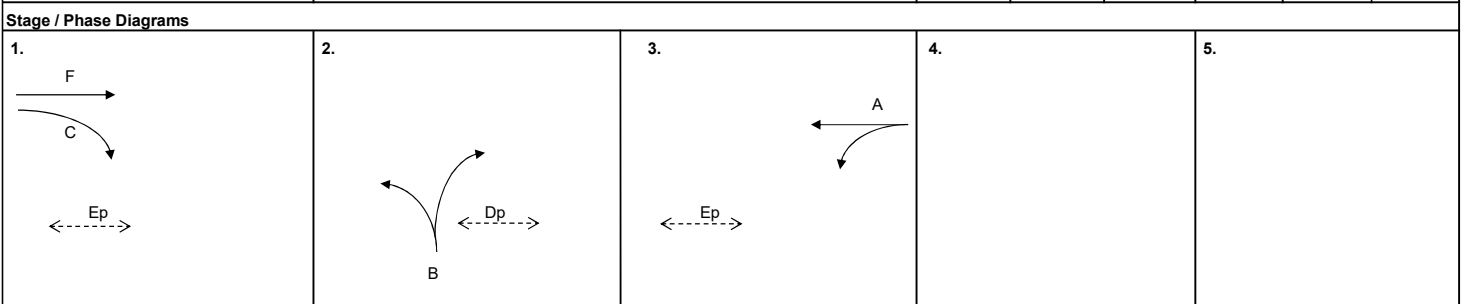

I/G= 5	I/G= 6	I/G= 6	I/G= 6	I/G= 6	I/G= 6	I/G= 6	I/G= 6
I/G= 5	I/G= 6	I/G= 6	I/G= 6	I/G= 6	I/G= 6	I/G= 6	I/G= 6
<b>Date:</b> APR, 2022						<b>Junction:</b> (J5) Castle Peak Road - Hung Shui Kiu / Shun Tat Street	

**TRAFFIC SIGNALS CALCULATION**

Job No.: CHK50637810

MVA HONG KONG LIMITED

Junction: Castle Peak Road - Hung Shui Kiu / Shun Tat Street

Design Year: 2030

Description: Reference Weekday AM/ PM Peak (Proposed Further Improvement Scheme)

Designed By: HWL

Checked By: TKM

Approach	Movements	Phase	Stage	Width (m)	Radius (m)		Gradient (%)	Pro. Turning (%)		Revised Saturation Flow (pcu/hr)		AM Peak			PM Peak		
					Left	Right		AM	PM	AM	PM	Flow (pcu/hr)	y Value	Critical y	Flow (pcu/hr)	y Value	Critical y
Castle Peak Rd	→	F	2,3	3,300						1945	1945	483	0.248		497	0.256	
Hung Shui Kiu	→	F	2,3	3,300						2085	2085	517	0.248		533	0.256	
EB	↓	C	2	3,300		15				1895	1895	110	0.058	0.058	115	0.061	0.061
Castle Peak Road	↔	A	3	3,800	15			29%	23%	1940	1950	378	0.195	0.195	442	0.227	0.227
Hung Shui Kiu	←	A	3	3,800						2135	2135	417	0.195		483	0.226	
WB	↔	B	1	4,000	12.5	17.5		76% / 24%	74% / 26%	1815	1815	225	0.124	0.124	190	0.105	0.105
Shun Tat Street	↔	B	1	4,000	12.5	17.5											
NB	↔	B	1	4,000	12.5	17.5											
Pedestrian Crossing		Dp	1	MIN GREEN + FLASH =		7	+	10	=	17							
		Ep	2,3	MIN GREEN + FLASH =		6	+	6	=	12							

Notes:	Flow: (pcu/hr)	Group	B,F		B,C,A		Group	Dp,C,A		B,C,A												
			y	L (sec)	C (sec)	y pract.		R.C. (%)	y	L (sec)	C (sec)	y pract.	R.C. (%)									
			0.372	9	120	0.833	124%	0.377	14	120	0.795	111%	0.287	32	120	0.660	130%	0.392	14	120	0.795	103%

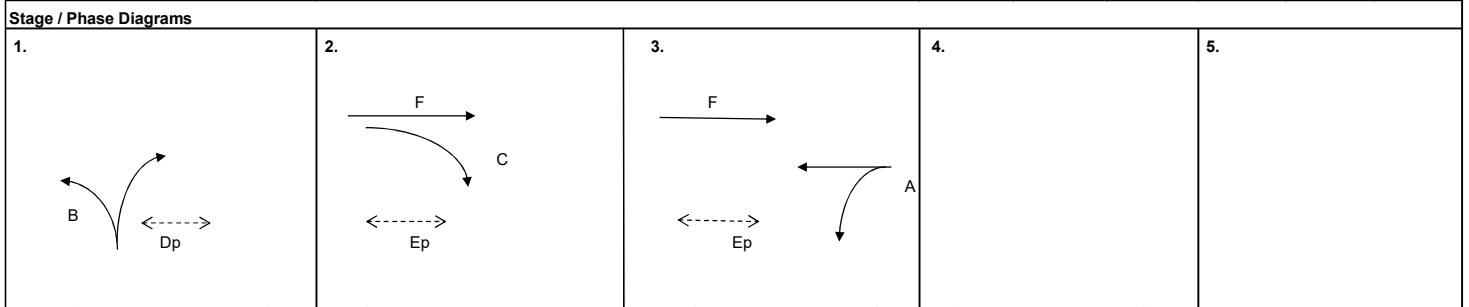

I/G= 6	I/G= 5	I/G= 6	I/G= 6	I/G=	I/G=
I/G= 6	I/G= 5	I/G= 6	I/G= 6	I/G=	I/G=
Date: APR, 2022				Junction: Castle Peak Road - Hung Shui Kiu / Shun Tat Street	

# Priority Junction Capacity Calculation



Job Title: CE 92/2017 (CE) Site Formation and Infrastructure Works for Development near Tan Kwai Tsuen, Yuen Long - IDC	Designed by: HWL
Junction: Shun Tat Street - Tat Fuk Road (J6)	Checked by: TKM
Scheme: Reference Weekday AM/ PM Peak	Date: Apr-22
Design Year: 2030	Job No.: CHK50637810
Arm A: Shun Tat Street (WB)	
Arm B: Tat Fuk Road (NB)	
Arm C: Shun Tat Street (EB)	
Arm D: Tat Fuk Road (SB)	

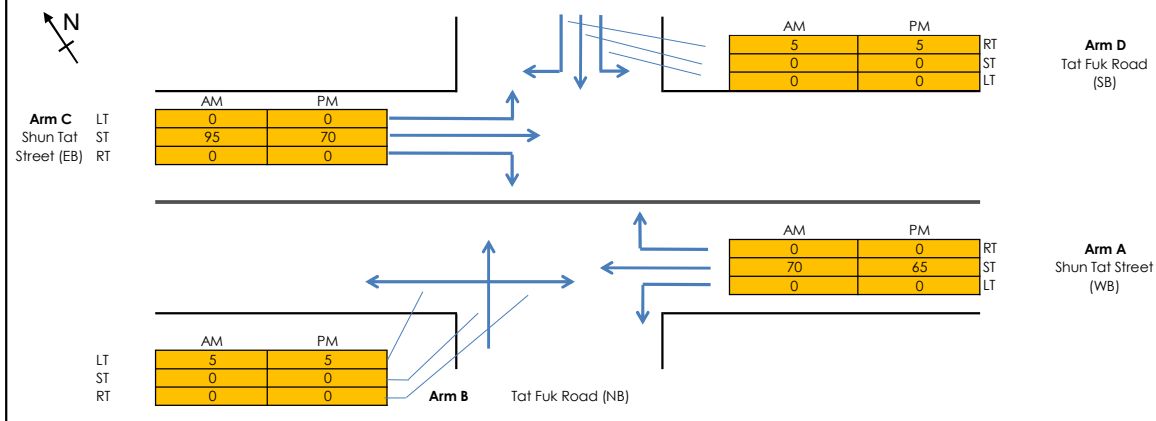

## GEOMETRY

Major Road Width (m)	W	10.00
Central Reserve Width (m)	Wcr	0.00

PARAMETER				Arm B				Arm D					
Lane widths (m)	w(b-a)	3.00	Blockage of major road RT (c-b block c-a)?	Y	w(d-c)	3.00	Blockage of major road RT (a-d block a-c)?	Y					
	w(b-c)	3.00				w(d-a)			3.00				
	w(c-b)	4.50				w(a-d)			4.50				
Visibility Distances (m)	Vr(b-a)	30	Calculated Parameters	D	E	120	Calculated Parameters	D	E				
	VI(b-a)	120								F	0.880	F	0.939
	Vr(b-c)	50								F	1.060	F	1.022
	Vr(c-b)	100								Y	0.655	Y	0.655
Straight ahead movement using left lane?		Y			Straight ahead movement using left lane?		Y						

## ANALYSIS

		AM Peak		PM Peak				AM Peak		PM Peak	
TRAFFIC FLOWS (pcu/hr)	q(a-b)	0	0	q(c-d)	0	0	TRAFFIC FLOWS (pcu/hr)	q(c-d)	0	0	
	q(a-c)	70	65	q(c-a)	95	70		q(c-b)	0	0	
	q(a-d)	0	0	q(c-b)	0	0		q(a-d)	0	0	
	q(c-a)	95	70	q(a-c)	70	65		q(a-b)	0	0	
	q(c-b)	0	0	q(d-a)	0	0		q(b-c)	5	5	
	q(c-d)	0	0	q(d-b)	0	0		q(b-d)	0	0	
	q(d-a)	0	0	q(d-c)	5	5		q(b-a)	0	0	
	q(d-b)	0	0	q(b-a)	0	0		q(d-c)	5	5	
	q(d-c)	5	5	q(b-d)	0	0		q(d-b)	0	0	
	q(b-a)	0	0	q(b-c)	5	5		q(d-a)	0	0	
Left turn proportion	F	1.00	1.00	Left turn proportion	F	0.00	0.00				

		AM Peak		PM Peak				AM Peak		PM Peak	
CAPACITIES (pcu/hr)	Q(b-ad)	510	514	Q(d-bc)	514	519	CAPACITIES (pcu/hr)	Q(d-abc)	514	519	
	Q(b-acd)	641	642	Q(a-d)	738	744		Q(a-c)	1800	1800	
	Q(c-b)	772	774								
	Q(c-a)	1800	1800								

RFC's		AM Peak		PM Peak		RFC's		AM Peak		PM Peak	
c-b	0.00	0.00	a-d	0.00	0.00	a-c	0.04	0.04			
c-a	0.05	0.04	d-acc	0.01	0.01						
b-acc	0.01	0.01									

## RFC

	0.05	0.04		0.04	0.04
--	------	------	--	------	------

Where VI and Vr are visibility distances to the left or right of the respective streams  
 $D = (1 + 0.094(w(b-a) - 3.65)) (1 + 0.0009(Vr(b-a) - 120)) (1 + 0.0006(VI(b-a) - 150))$   
 $E = (1 + 0.094(w(b-c) - 3.65)) (1 + 0.0009(Vr(b-c) - 120))$   
 $F = (1 + 0.094(w(c-b) - 3.65)) (1 + 0.0009(Vr(c-b) - 120))$   
 $Y = 1 - 0.0345W$   
 F = proportion of minor traffic turning left  
 $Q(b-ad) = Q(b-a) * Q(b-d) / (0.5 * Q(b-a) + 0.5 * Q(b-d))$  Capacity of combined streams  
 $Q(b-acc) = Q(b-c) * Q(b-ad) / ((1-F) * Q(b-c) + F * Q(b-ad))$  Capacity of combined streams

All the above formulas are in accordance to T.P.D.M. Vol.2 Chapter 4 Appendix 1

**TRAFFIC SIGNALS CALCULATION**

Job No.: **CHK50637810**

**MVA HONG KONG LIMITED**

Junction: Shun Tat Street / Tung Fuk Road

Design Year: 2030

Description: Reference Weekday AM/ PM Peak (Proposed Future Layout)

Designed By: HWL

Checked By: TKM

Approach	Movements	Phase	Stage	Width (m)	Radius (m)		Gradient (%)	Pro. Turning (%)		Revised Saturation Flow (pcu/hr)		AM Peak			PM Peak		
					Left	Right		AM	PM	AM	PM	Flow (pcu/hr)	y Value	Critical y	Flow (pcu/hr)	y Value	Critical y
Shun Tat Street EB	↔	A	1	3.100	12.5					1720	1720	0	0.000	0.000	0	0.000	0.000
	↕	A	1	3.100		7.5		16%	15%	2000	2005	95	0.048		65	0.032	
Access Road SB	↕↔	B	2	4.000	10	20		0% / 100%	0% / 100%	1875	1875	5	0.003	0.003	5	0.003	0.003
Local Road WB	↕↔	C	4	3.500		15		0%	0%	1965	1965	5	0.003		5	0.003	
Tung Fuk Road NB	↔↕	D	5	3.000	7.5	15		100% / 0%	100% / 0%	1595	1595	5	0.003		5	0.003	
	↕	F	3	6.000		8		0%	0%	2215	2215	65	0.029		65	0.029	
Pedestrian Crossing		Ep	3,4	MIN GREEN + FLASH =			5	+	9	=	14						

<b>Notes:</b>	<b>Flow: (pcu/hr)</b>						<b>Group</b>	A,B,Ep,D	A,B,F,C,D	<b>Group</b>	A,B,Ep,D	A,B,F,C,D
	<b>y</b>	0.003	0.003	<b>y</b>	0.003	0.003						
	<b>L (sec)</b>	46	48	<b>L (sec)</b>	46	48						
	<b>C (sec)</b>	90	90	<b>C (sec)</b>	90	90						
	<b>y pract.</b>	0.440	0.420	<b>y pract.</b>	0.440	0.420						
	<b>R.C. (%)</b>	16400%	15650%	<b>R.C. (%)</b>	16400%	15650%						

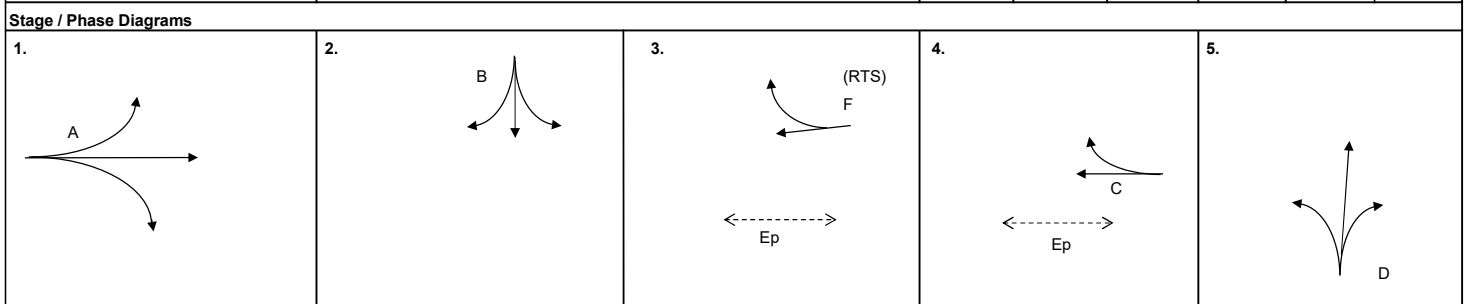

I/G= 7	I/G= 7	I/G= 6	5	I/G= 5	5	I/G= 9	5
I/G= 7	I/G= 7	I/G= 6	5	I/G= 5	5	I/G= 9	5
<b>Date:</b> APR, 2022						<b>Junction:</b> Shun Tat Street / Tung Fuk Road	



**TRAFFIC SIGNALS CALCULATION**

Job No.: **CHK50637810**

**MVA HONG KONG LIMITED**

Junction: Castle Peak Road - Hung Shui Kiu / Fuk Hang Tsuen Road

Design Year: 2030

Description: Reference Weekday AM/ PM Peak (Proposed CE2 2011 Layout)

Designed By: HWL

Checked By: TKM

Approach	Movements	Phase	Stage	Width (m)	Radius (m)		Gradient (%)	Pro. Turning (%)		Revised Saturation Flow (pcu/hr)		AM Peak			PM Peak		
					Left	Right		AM	PM	AM	PM	Flow (pcu/hr)	y Value	Critical y	Flow (pcu/hr)	y Value	Critical y
Castle Peak Rd	→	E	1	3.250						2080	2080	780	0.375	0.375	808	0.388	0.388
Hung Shui Kiu	→	E	1	3.250						2080	2080	780	0.375		807	0.388	
EB	↓	P	2	3.000		15				1740	1740	215	0.124		215	0.124	
Castle Peak Rd	↔	F	1	3.750	15			17%	18%	1955	1955	401	0.205		426	0.218	
Hung Shui Kiu	←	F	1	3.750						2130	2130	437	0.205		465	0.218	
WB	←	F	1	3.750						2130	2130	437	0.205		464	0.218	
Fuk Hang Tsuen Road (NB)	↕	K	3	3.300	12.5	10		88% / 13%	85% / 15%	1730	1730	320	0.185	0.185	260	0.150	0.150
Pedestrian Crossing		Hp	2	MIN GREEN + FLASH =		10	+	10	=	20				*			*
		Gp	2,3	MIN GREEN + FLASH =		10	+	10	=	20							

Notes:	Flow: (pcu/hr)	Group	E,P,K	E,Hp,K	Group	E,P,K	E,Hp,K
		y	0.684	0.560	y	0.662	0.539
		L (sec)	15	34	L (sec)	15	34
		C (sec)	100	100	C (sec)	100	100
		y pract.	0.765	0.594	y pract.	0.765	0.594
		R.C. (%)	12%	6%	R.C. (%)	16%	10%

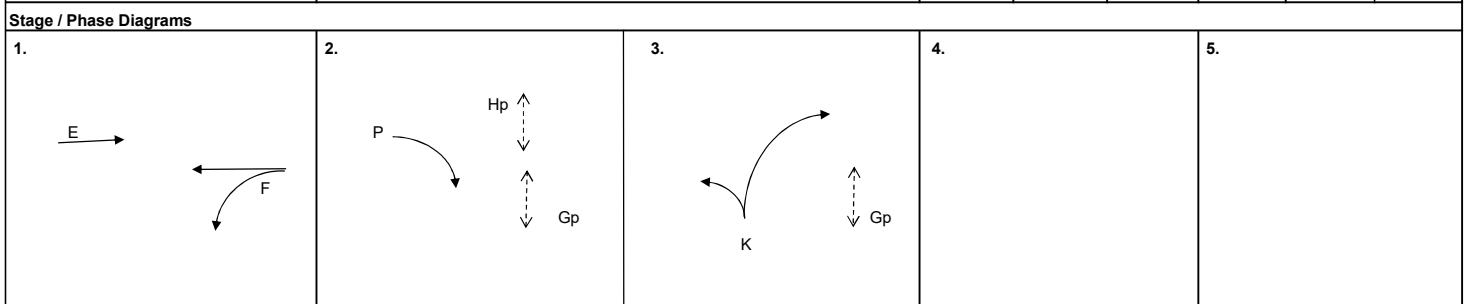

I/G= 7	I/G= 7	I/G= 7	20	I/G= 2	I/G=	I/G=	I/G=
I/G= 7	I/G= 7	I/G= 7	20	I/G= 2	I/G=	I/G=	I/G=
<b>Date:</b> APR, 2022						<b>Junction:</b> Castle Peak Road - Hung Shui Kiu / Fuk Hang Tsuen Road (J8)	

**TRAFFIC SIGNALS CALCULATION**

Job No.: **CHK50637810**

**MVA HONG KONG LIMITED**

Junction: Castle Peak Road - Hung Shui Kiu / Fuk Hang Tsuen Rd

Design Year: 2030

Description: Reference Weekday AM/ PM Peak (Proposed Further Improvement Scheme)

Designed By: HWL

Checked By: TKM

Approach	Movements	Phase	Stage	Width (m)	Radius (m)		Gradient (%)	Pro. Turning (%)		Revised Saturation Flow (pcu/hr)		AM Peak			PM Peak		
					Left	Right		AM	PM	AM	PM	Flow (pcu/hr)	y Value	Critical y	Flow (pcu/hr)	y Value	Critical y
Castle Peak Rd	→	E	1,4	3.250						2080	2080	780	0.375	0.375	808	0.388	0.388
Hung Shui Kiu	→	E	1,4	3.250						2080	2080	780	0.375	0.375	807	0.388	0.388
EB	↓	P	2	3.000		15				1870	1870	215	0.115	0.115	215	0.115	0.115
Castle Peak Rd	↔	F	1	3.500	15			17%	18%	1930	1930	401	0.208		426	0.221	
Hung Shui Kiu	←	F	1	3.500						2105	2105	437	0.208		465	0.221	
WB	←	F	1	3.500						2105	2105	437	0.208		464	0.220	
Fuk Hang Tsuen Road (NB)	↕	K	3	3.300	15					1770	1770	154	0.087	0.087	125	0.071	
	↕	K	3	3.300	17.5	12.5		76% / 24%	70% / 30%	1905	1905	166	0.087		135	0.071	0.071
Pedestrian Crossing		Hp	2	MIN GREEN + FLASH =		10	+	10	=	20							
		Gp	2,3	MIN GREEN + FLASH =		10	+	10	=	20							
		lp	4	MIN GREEN + FLASH =		5	+	14	=	19							

<b>Notes:</b>	<b>Flow: (pcu/hr)</b>			<b>Group</b>	E, Hp, K	E, P, K	<b>Group</b>	F, P, K, lp	E, P, K
				<b>y</b>	0.462	0.577	<b>y</b>	0.407	0.574
				<b>L (sec)</b>	30	13	<b>L (sec)</b>	38	13
				<b>C (sec)</b>	120	120	<b>C (sec)</b>	120	120
				<b>y pract.</b>	0.675	0.803	<b>y pract.</b>	0.615	0.803
				<b>R.C. (%)</b>	46%	39%	<b>R.C. (%)</b>	51%	40%

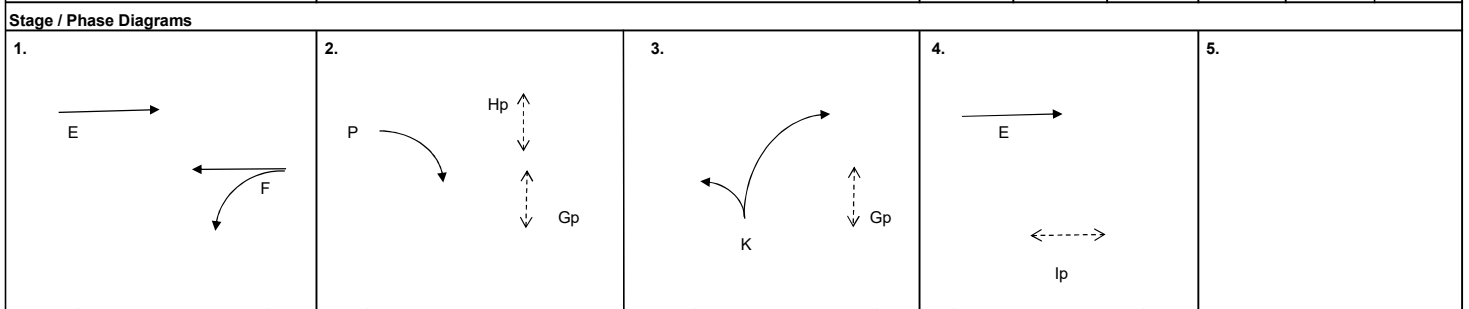

I/G=		I/G= 5		I/G= 6		I/G= 5		I/G=	
I/G=		I/G= 5		I/G= 6		I/G= 5		I/G=	
<b>Date:</b> APR, 2022							<b>Junction:</b> Castle Peak Road - Hung Shui Kiu / Fuk Hang Tsuen Rd		

(J8)

**TRAFFIC SIGNALS CALCULATION**

Job No.: **CHK50637810**

**MVA HONG KONG LIMITED**

Junction: Castle Peak Road - Hung Tin Road

Design Year: 2030

Description: Reference Weekday AM/ PM Peak

Designed By: HWL

Checked By: TKM

Approach	Movements	Phase	Stage	Width (m)	Radius (m)		Gradient (%)	Pro. Turning (%)		Revised Saturation Flow (pcu/hr)		AM Peak			PM Peak		
					Left	Right		AM	PM	AM	PM	Flow (pcu/hr)	y Value	Critical y	Flow (pcu/hr)	y Value	Critical y
Hung Tin Road SB	L	F	2	3.300	12.5					1735	1735	100	0.058		75	0.043	
	↕	F	2	3.500	15	15	0% / 100%	0% / 100%	1915	1915	209	0.109		177	0.092		
	↕	F	2	3.500		12.5			1880	1880	206	0.110		173	0.092		
Castle Peak Road	↖	C	2,3	3.300	22.5					1825	1825	390	0.214	0.214	355	0.195	0.195
Hung Shui Kiu	→	B	3,4	3.650						1980	1980	186	0.094		229	0.116	
EB	→	B	3,4	3.650						2120	2120	199	0.094		246	0.116	
Castle Peak Road	←	D	1,3,4	3.650						1980	1980	278	0.140		232	0.117	
Hung Shui Kiu	←	D	1,3,4	3.650						2120	2120	297	0.140		248	0.117	
WB	↖	E	1	3.400		15				1905	1905	405	0.213	0.213	345	0.181	0.181
LRT (FIXED TIME)		A	4	MIN GREEN + (FLASH + /			20	+	16	=	36			*			*
Pedestrian Crossing	Gp	1	MIN GREEN + FLASH =			5	+	9	=	14							
	Hp	1,2,3	MIN GREEN + FLASH =			5	+	8	=	13							
	lp	1,3,4	MIN GREEN + FLASH =			5	+	9	=	14							
	Jp	4	MIN GREEN + FLASH =			7	+	14	=	21							
	Kp	2	MIN GREEN + FLASH =			8	+	7	=	15							

Notes:	Flow: (pcu/hr)	Group	E,F,Hp,A	E,C,A	Group	E,F,Hp,A	E,C,A
		<b>y</b>	0.322	0.426	<b>y</b>	0.273	0.376
		<b>L (sec)</b>	59	51	<b>L (sec)</b>	57	49
		<b>C (sec)</b>	130	130	<b>C (sec)</b>	130	130
		<b>y pract.</b>	0.492	0.547	<b>y pract.</b>	0.505	0.561
		<b>R.C. (%)</b>	53%	28%	<b>R.C. (%)</b>	85%	49%

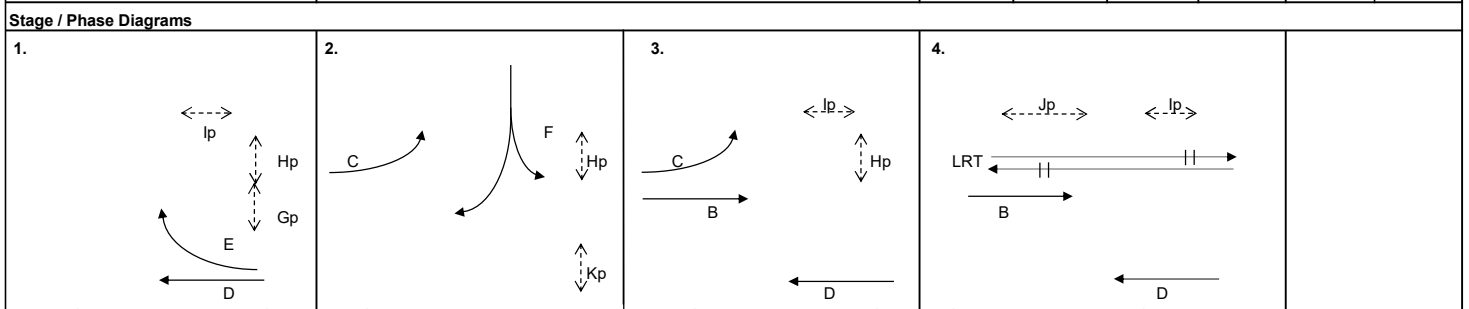

I/G= 2	I/G= 9	I/G=	I/G= 6	36	I/G=
I/G=	I/G= 9	I/G=	I/G= 6	36	I/G=
			<b>Date:</b> APR, 2022	<b>Junction:</b> Castle Peak Road - Hung Tin Road	

## Priority Junction Capacity Calculation

Job Title: CE 92/2017 (CE) Site Formation and Infrastructure Works for Development near Tan Kwai Tsuen, Yuen Long - IDC	Designed by: HWL
Junction: Tan Kwai Tsuen Road - Shui Fu Road (J10)	Checked by: TKM
Scheme: Reference Weekday AM/ PM Peak	Date: Apr-22
Design Year: 2030	Job No.: CHK50637810
Arm A: Tan Kwai Tsuen Road (SB)	
Arm B: Shui Fu Road	
Arm C: Tan Kwai Tsuen Road (NB)	

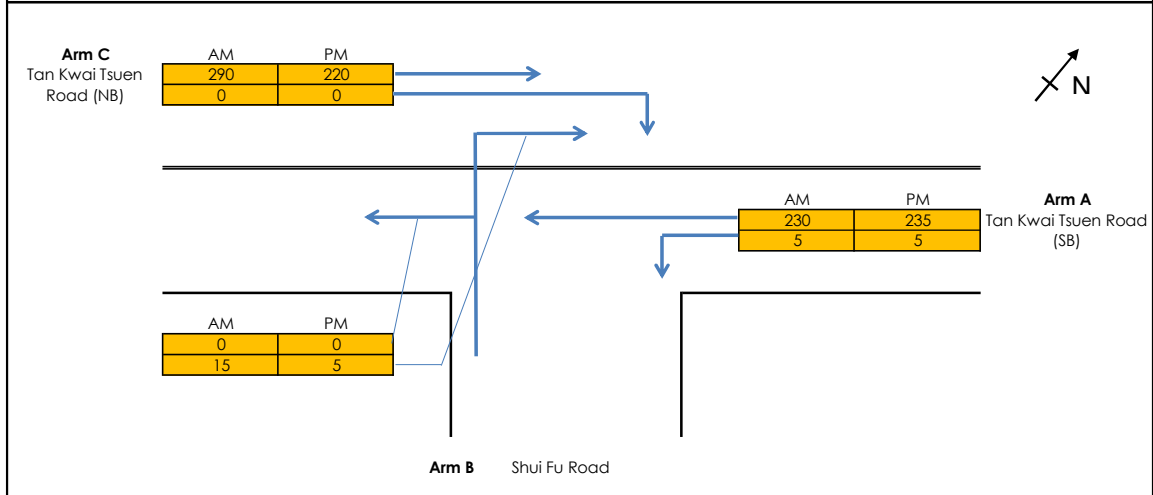

### GEOMETRY

Major Road Width (m)	W	7.25	Lane widths (m)	w(b-a)	3.00
Central Reserve Width (m)	Wcr	0.00		w(b-c)	3.00
Blockage of major road right turn	Y/N?	Y		w(c-b)	3.50
Combined stream on minor arm	Y/N?	Y			
Visibility Distances (m)	Vr(b-a)	80	Calculated Parameters	D	0.867
	VI(b-a)	80		E	0.905
	Vr(b-c)	80		F	0.933
	Vr(c-b)	60		Y	0.75

### ANALYSIS

		AM	PM
TRAFFIC FLOWS (pcu/hr)	q(c-a)	290	220
	q(c-b)	0	0
	q(a-b)	5	5
	q(a-c)	230	235
	q(b-a)	15	5
	q(b-c)	0	0
	f	0.00	0.00
CAPACITIES (pcu/hr)	Q(b-ac)	446	455
	Q(c-a)	1800	1800
	Q(c-b)	635	634
RFC's	c-a	0.16	0.12
	c-b	0.00	0.00
	b-ac	0.03	0.01
<b>RFC</b>		<b>0.16</b>	<b>0.12</b>

Where VI and Vr are visibility distances to the left or right of the respective streams  
 $D = (1 + 0.094(w(b-a) - 3.65))(1 + 0.0009(Vr(b-a) - 120))(1 + 0.0006(VI(b-a) - 150))$   
 $E = (1 + 0.094(w(b-c) - 3.65))(1 + 0.0009(Vr(b-c) - 120))$   
 $F = (1 + 0.094(w(c-b) - 3.65))(1 + 0.0009(Vr(c-b) - 120))$   
 $Y = 1 - 0.0345W$   
 f = proportion of minor traffic turning left  
 $Q(b-ac) = Q(b-c) * Q(b-a) / (1 - f) * Q(b-c) + f * Q(b-a)$  Capacity of combined streams

All the above formulas are in accordance to T.P.D.M. V.2.4 Appendix 1

**TRAFFIC SIGNALS CALCULATION**

Job No.: **CHK50637810**

**MVA HONG KONG LIMITED**

Junction: Shui Fu Road / Proposed Access Road

Design Year: 2030

Description: Reference Weekday AM/ PM Peak

Designed By: HWL

Checked By: TKM

Approach	Movements	Phase	Stage	Width (m)	Radius (m)		Gradient (%)	Pro. Turning (%)		Revised Saturation Flow (pcu/hr)		AM Peak			PM Peak		
					Left	Right		AM	PM	AM	PM	Flow (pcu/hr)	y Value	Critical y	Flow (pcu/hr)	y Value	Critical y
Access Road (WB)	↓	B	2	4.500	7.5			0%	0%	2065	2065	5	0.002	0.002	5	0.002	0.002
Access Road (EB)	↑	A	1	5.000		18		100%	100%	1950	1950	5	0.003	0.003	5	0.003	0.003
Shui Fu Road (Lower section)	←	C	3	5.000	22.5	15		100% / 0%	100% / 0%	1985	1985	5	0.003	0.003	5	0.003	0.003
Shui Fu Road (Upper section)	←	D	4	5.000	22.5	12.5		0% / 100%	0% / 100%	1890	1890	10	0.005	0.005	5	0.003	0.003
Pedestrian Crossing		Ep	5	MIN GREEN + FLASH =		7	+	9	=	16				*			*
		Fp	5	MIN GREEN + FLASH =		7	+	9	=	16							

Notes:	Flow: (pcu/hr)		Group	A,B,C,D,Ep	A,B,C,D,Ep	Group	A,B,C,D,Ep	A,B,C,D,Ep
						y	0.013	0.013
			L (sec)	47	47	L (sec)	47	47
			C (sec)	100	100	C (sec)	100	100
			y pract.	0.477	0.477	y pract.	0.477	0.477
			R.C. (%)	3628%	3628%	R.C. (%)	4600%	4600%

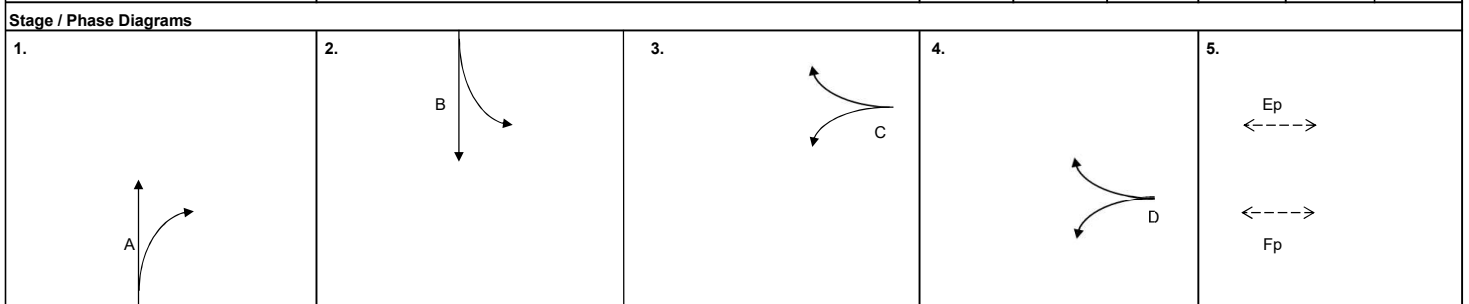

I/G= 7		I/G= 7		I/G= 7		I/G= 7		I/G= 7	16
I/G= 7		I/G= 7		I/G= 7		I/G= 7		I/G= 7	16
<b>Date:</b> APR, 2022								<b>Junction:</b> Shui Fu Road / Proposed Access Road	

# 2030 Design Junction Calculations

## TRAFFIC SIGNALS CALCULATION

Job No.: **CHK50637810**

MVA HONG KONG LIMITED

Junction: Hung Tin Road / Hung Chi Road

Design Year: 2030

Description: Design Weekday AM/ PM Peak

Designed By: HWL

Checked By: TKM

Approach	Movements	Phase	Stage	Width (m)	Radius (m)		Gradient (%)	Pro. Turning (%)		Revised Saturation Flow (pcu/hr)		AM Peak			PM Peak		
					Left	Right		AM	PM	AM	PM	Flow (pcu/hr)	y Value	Critical y	Flow (pcu/hr)	y Value	Critical y
Hung Tin Road NB	↕	G	4	3.400	12.5			92%	96%	1760	1750	653	0.371		649	0.371	0.371
	↕	G	4	3.400		12.5		64%	68%	1945	1935	722	0.371	0.371	717	0.371	
	↕	G	4	3.400		10				1820	1820	675	0.371		674	0.370	
Hung Chi Road EB	↔	H	1	3.500	12.5			63%	73%	1830	1805	64	0.035		41	0.023	
	↔	H	1	3.500						2105	2105	73	0.035		47	0.022	
	↔	H	1	3.500						2105	2105	73	0.035		47	0.022	
Shek Po East Rd SB	↕	I	3	4.500	12.5					1845	1845	70	0.038	0.038	50	0.027	
HSK Interchange EB	↔	A	1,4	3.400						1955	1955	175	0.090		150	0.077	
	↔	B	4	3.400		20				1950	1950	604	0.310		589	0.302	
	↔	B	4	3.400		15				1905	1905	591	0.310		576	0.302	
HSK Interchange WB	↔	F	2	3.500		15				1915	1915	30	0.016		40	0.021	
	↔	E	1,2	3.300						1945	1945	80	0.041		55	0.028	
Hung Tin Road SB	↕	C	4	3.400	10			14%	12%	1915	1920	174	0.091		127	0.066	0.066
	↕	C	4	3.400						2095	2095	191	0.091	0.091	138	0.066	
	↕	C	4	3.400		17.5				1930	1930	70	0.036		45	0.023	
Hung Chi Road WB	↔	D	1	3.500						2105	2105	40	0.019		50	0.024	
	↔	D	1	3.500	10					1710	1710	75	0.044	0.044	115	0.067	0.067
Pedestrian Crossing	Jp	3,4	MIN GREEN + FLASH =		7	+	10	=	17								
	Kp	3	MIN GREEN + FLASH =		6	+	6	=	12								
	Lp	2,3,4	MIN GREEN + FLASH =		6	+	6	=	12								
	Mp	3	MIN GREEN + FLASH =		7	+	9	=	16								
	Np	1,2,3	MIN GREEN + FLASH =		7	+	10	=	17								
	Op	3	MIN GREEN + FLASH =		6	+	6	=	12								
	Pp	2,3,4	MIN GREEN + FLASH =		7	+	9	=	16								

Notes:	Traffic Flow (pcu/hr)	Group	H.C.I,G	D.C.I,G	Group	H.C.I,G	D.C.I,G
		<b>y</b>	0.535	0.544	<b>y</b>	0.437	0.504
		<b>L (sec)</b>	22	21	<b>L (sec)</b>	34	27
		<b>C (sec)</b>	120	120	<b>C (sec)</b>	120	120
		<b>y pract.</b>	0.735	0.743	<b>y pract.</b>	0.645	0.698
		<b>R.C. (%)</b>	37%	36%	<b>R.C. (%)</b>	48%	38%

Stage / Phase Diagrams							
1.	2.	3.	4.	5.			
I/G= 6	I/G= 6	I/G= 6	I/G= 7	I/G=			
I/G= 6	I/G= 6	I/G= 6	I/G= 7	I/G=			

Date: **APR, 2022** Junction: **Hung Tin Road / Hung Chi Road** (J1)

**TRAFFIC SIGNALS CALCULATION**

Job No.: CHK50637810

MVA HONG KONG LIMITED

Junction: Castle Peak Road - Hung Shui Kiu / Hung Tak Road

Design Year: 2030

Description: Design Weekday AM/ PM Peak (TD Improvement Scheme)

Designed By: HWL

Checked By: TKM

Approach	Movements	Phase	Stage	Width (m)	Radius (m)		Gradient (%)	Pro. Turning (%)		Revised Saturation Flow (pcu/hr)		AM Peak			PM Peak		
					Left	Right		AM	PM	AM	PM	Flow (pcu/hr)	y Value	Critical y	Flow (pcu/hr)	y Value	Critical y
Castle Peak Road - Hung Shui Kiu WB	↙ ← ↑	C D D	2 1 1	3.300 3.300 3.300	15					1770 2085 2085	1770 2085 2085	455 380 380	0.257 0.182 0.182	0.257 0.182	350 325 325	0.198 0.156 0.156	0.198 0.156
Hung Tak Road NB	**↖↗	B	2	3.500	10	15	14% / 86%	12% / 88%		1920	1920	380	0.198		215	0.112	
Castle Peak Road - Hung Shui Kiu EB	*→	A A A	1 1 1	3.300 3.300 3.300						1750 2085 2085	1750 2085 2085	202 242 241	0.115 0.116 0.116		248 296 296	0.142 0.142 0.142	
Pedestrian Crossing		Ep Fp Gp	1,3 1,3 3	MIN GREEN + FLASH = MIN GREEN + FLASH = MIN GREEN + FLASH =	5 5 10	+	7 6 8	= = =	12 11 18					*			*

Notes:	Flow: (pcu/hr)	Group	D.B.Gp	D.C.Gp	Group	A.C.Gp	D.C.Gp
			<p>* Site factor = 0.9 is used (Effect of bus stop situated at Castle Peak Road - Hung Shui Kiu EB)</p> <p>** Saturation flow at Hung Tak Road increased</p>			<p>y</p> <p>L (sec)</p> <p>C (sec)</p> <p>y pract.</p> <p>R.C. (%)</p>	0.380

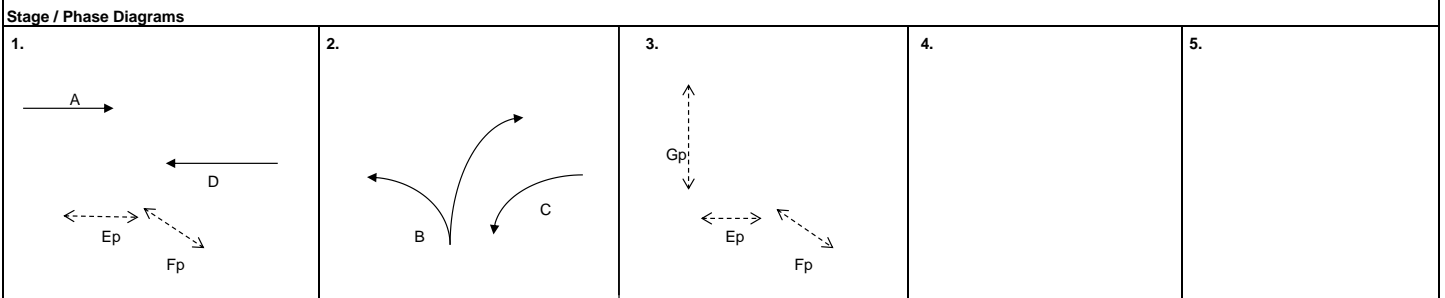

I/G= 2	I/G= 5	I/G= 4	18	I/G=	I/G=
I/G= 2	I/G= 5	I/G= 4	18	I/G=	I/G=

Date: SEP, 2022 Junction: Castle Peak Road - Hung Shui Kiu / Hung Tak Road (J2)

**TRAFFIC SIGNALS CALCULATION**

Job No.: **CHK50637810**

**MVA HONG KONG LIMITED**

Junction: Castle Peak Road - Hung Shui Kiu/ Tan Kwai Tsuen Road

Design Year: 2030

Description: Design Weekday AM/ PM Peak (TD Improvement Scheme)

Designed By: HWL

Checked By: TKM

Approach	Movements	Phase	Stage	Width (m)	Radius (m)		Gradient (%)	Pro. Turning (%)		Revised Saturation Flow (pcu/hr)		AM Peak			PM Peak		
					Left	Right		AM	PM	AM	PM	Flow (pcu/hr)	y Value	Critical y	Flow (pcu/hr)	y Value	Critical y
Castle Peak Rd Hung Shui Kiu WB	→ → ↘	I I H	1,2 1,2 2	3.300 3.300 3.300						1945 2085 1985	1945 2085 1985	253 272 200	0.130 0.130 0.101	0.101	345 370 220	0.177 0.177 0.111	0.111
Castle Peak Rd Hung Shui Kiu EB	← ←	G G	1 1	3.650 3.650						1980 2120	1980 2120	394 421	0.199 0.199	0.199	326 349	0.165 0.165	0.165
Tan Kwai Tsuen Road NB	↕	F	3	4.000	15	17.5		63% / 37%	63% / 37%	1840	1840	435	0.236	0.236	335	0.182	0.182
Pedestrian Crossing		Jp	1	MIN GREEN + FLASH =			10	+	7	=	17						

<b>Notes:</b>	<b>Flow: (pcu/hr)</b>			<b>Group</b>	Jp,H,F	G,H,F	<b>Group</b>	Jp,H,F	G,H,F
		<b>y</b>	0.337	0.536	<b>y</b>	0.293	0.458		
		<b>L (sec)</b>	29	19	<b>L (sec)</b>	29	19		
		<b>C (sec)</b>	90	90	<b>C (sec)</b>	90	90		
		<b>y pract.</b>	0.610	0.710	<b>y pract.</b>	0.610	0.710		
		<b>R.C. (%)</b>	81%	32%	<b>R.C. (%)</b>	108%	55%		

<b>Stage / Phase Diagrams</b>									
1. 	2. 	3. 	4.	5.					

I/G= 6	I/G= 7	I/G= 9	I/G=	I/G=
I/G= 6	I/G= 7	I/G= 9	I/G=	I/G=
<b>Date:</b> SEP, 2022			<b>Junction:</b> Castle Peak Road / Tan Kwai Tsuen Road (MN37)	

(J3)



# Priority Junction Capacity Calculation

Job Title: CE 92/2017 (CE) Site Formation and Infrastructure Works for Development near Tan Kwai Tsuen, Yuen Long - IDC		Designed by: HWL
Junction: Tan Kwai Tsuen Road - Hung Shun Road (J4)		Checked by: TKM
Scheme: Design Weekday AM/ PM Peak	Design Year 2030	Date: Sep-22
Job No.: CHK50637810		

Arm A: Tan Kwai Tsuen Road (SB)
Arm B: Hung Shun Road
Arm C: Tan Kwai Tsuen Road (NB)

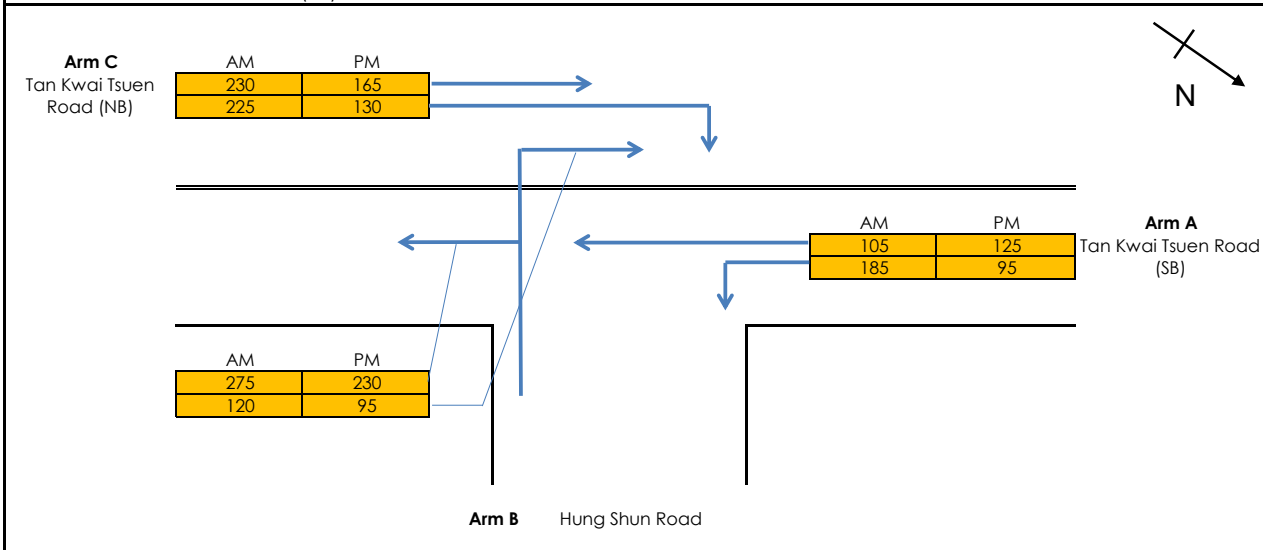

GEOMETRY			
Major Road Width (m)	W	8.00	Lane widths (m)
Central Reserve Width (m)	Wcr	0.00	w(b-a)
Blockage of major road right turn	Y/N?	Y	w(b-c)
Combined stream on minor arm	Y/N?	Y	w(c-b)
			3.50
			3.50
			3.50

Visibility Distances (m)	Vr(b-a)	60	Calculated Parameters	D	0.863
	VI(b-a)	25		E	0.942
	Vr(b-c)	70		F	0.968
	Vr(c-b)	100		Y	0.724

ANALYSIS		AM	PM
TRAFFIC FLOWS (pcu/hr)	q(c-a)	230	165
	q(c-b)	225	130
	q(a-b)	185	95
	q(a-c)	105	125
	q(b-a)	120	95
	q(b-c)	275	230
	f	0.70	0.71
CAPACITIES (pcu/hr)	Q(b-ac)	547	575
	Q(c-a)	1174.31	1448
	Q(c-b)	647	665
RFC's	c-a	0.20	0.11
	c-b	0.35	0.20
	b-ac	0.72	0.56
<b>RFC</b>		<b>0.72</b>	<b>0.56</b>

Where VI and Vr are visibility distances to the left or right of the respective streams  
 $D = (1+0.094(w(b-a)-3.65))(1+0.0009(Vr(b-a)-120))(1+0.0006(VI(b-a)-150))$   
 $E = (1+0.094(w(b-c)-3.65))(1+0.0009(Vr(b-c)-120))$   
 $F = (1+0.094(w(c-b)-3.65))(1+0.0009(Vr(c-b)-120))$   
 $Y = 1-0.0345W$   
 f = proportion of minor traffic turning left  
 $Q(b-ac) = Q(b-c)*Q(b-a)/(1-f)*Q(b-c)+f*Q(b-a)$  Capacity of combined streams

All the above formulas are in accordance to T.P.D.M. V.2.4 Appendix 1

**TRAFFIC SIGNALS CALCULATION**

Job No.: CHK50637810

MVA HONG KONG LIMITED

Junction: Castle Peak Road - Hung Shui Kiu / Shun Tat Street

Design Year: 2030

Description: Design Weekday AM/ PM Peak (TD Improvement Scheme)

Designed By: HWL

Checked By: TKM

Approach	Movements	Phase	Stage	Width (m)	Radius (m)		Gradient (%)	Pro. Turning (%)		Revised Saturation Flow (pcu/hr)		AM Peak			PM Peak		
					Left	Right		AM	PM	AM	PM	Flow (pcu/hr)	y Value	Critical y	Flow (pcu/hr)	y Value	Critical y
Castle Peak Rd	→	F	1	3.500						2105	2105	659	0.313	0.313	663	0.315	0.315
Hung Shui Kiu EB	↕	C	1	3.500		20		46%	43%	2035	2040	636	0.313		642	0.315	
Castle Peak Road	↕	A	3	3.800	15			42%	34%	1915	1930	428	0.223	0.223	468	0.242	0.242
Hung Shui Kiu WB	←	A	3	3.800						2135	2135	477	0.223		517	0.242	
Shun Tat Street NB	↕	B	2	4.000	12.5	17.5		72% / 28%	71% / 29%	1815	1815	520	0.287	0.287	430	0.237	0.237
Pedestrian Crossing		Dp	2	MIN GREEN + FLASH =		7	+	10	=	17							
		Ep	1,3	MIN GREEN + FLASH =		6	+	6	=	12							

<b>Notes:</b>	<b>Flow: (pcu/hr)</b>	<b>Group</b>	C,Dp,A	F,B,A	<b>Group</b>	C,Dp,A	F,B,A
		<b>y</b>	0.536	0.823	<b>y</b>	0.557	0.794
		<b>L (sec)</b>	30	14	<b>L (sec)</b>	30	14
		<b>C (sec)</b>	120	120	<b>C (sec)</b>	120	120
		<b>y pract.</b>	0.675	0.795	<b>y pract.</b>	0.675	0.795
		<b>R.C. (%)</b>	26%	-3%	<b>R.C. (%)</b>	21%	0%

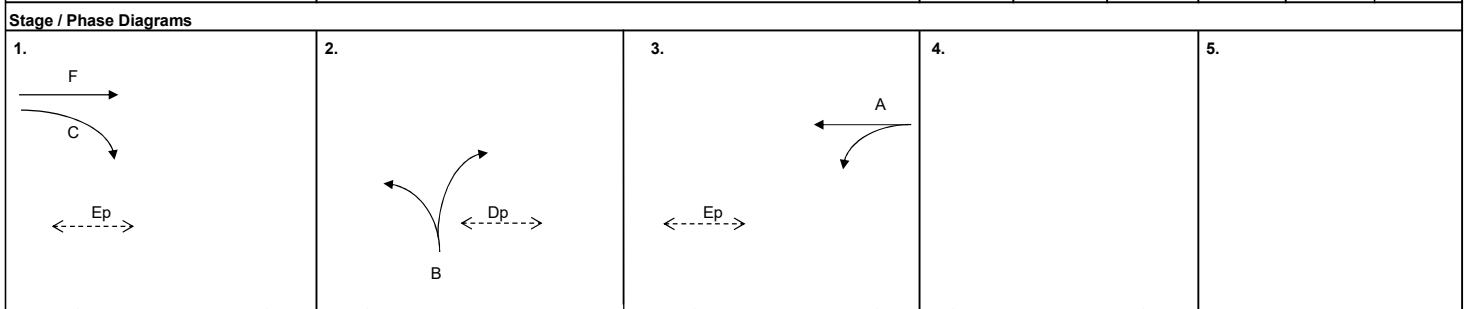

I/G= 5	I/G= 6	I/G= 6	I/G= 6	I/G= 6	I/G= 6	I/G= 6	I/G= 6
I/G= 5	I/G= 6	I/G= 6	I/G= 6	I/G= 6	I/G= 6	I/G= 6	I/G= 6
<b>Date:</b> APR, 2022						<b>Junction:</b> Castle Peak Road - Hung Shui Kiu / Shun Tat Street	

**TRAFFIC SIGNALS CALCULATION**

Job No.: CHK50637810

MVA HONG KONG LIMITED

Junction: Castle Peak Road - Hung Shui Kiu / Shun Tat Street

Design Year: 2030

Description: Design Weekday AM/ PM Peak (Proposed Further Improvement Scheme)

Designed By: HWL

Checked By: TKM

Approach	Movements	Phase	Stage	Width (m)	Radius (m)		Gradient (%)	Pro. Turning (%)		Revised Saturation Flow (pcu/hr)		AM Peak			PM Peak		
					Left	Right		AM	PM	AM	PM	Flow (pcu/hr)	y Value	Critical y	Flow (pcu/hr)	y Value	Critical y
Castle Peak Rd	→	F	2,3	3,300						1945	1945	483	0.248		497	0.256	
Hung Shui Kiu	→	F	2,3	3,300						2085	2085	517	0.248		533	0.256	
EB	↓	C	2	3,300		15				1895	1895	295	0.156	0.156	275	0.145	0.145
Castle Peak Road	↔	A	3	3,800	15			42%	34%	1915	1930	428	0.223	0.223	468	0.242	0.242
Hung Shui Kiu	←	A	3	3,800						2135	2135	477	0.223		517	0.242	
WB																	
Shun Tat Street	↕	B	1	4,000	12.5	17.5		72% / 28%	71% / 29%	1815	1815	520	0.287	0.287	430	0.237	0.237
NB																	
Pedestrian Crossing		Dp	1	MIN GREEN + FLASH =		7	+	10	=	17							
		Ep	2,3	MIN GREEN + FLASH =		6	+	6	=	12							

Notes:	Flow: (pcu/hr)	Group	B,F		B,C,A		Group	B,F		B,C,A		
			y	L (sec)	C (sec)	y pract.		R.C. (%)	y	L (sec)	C (sec)	y pract.
			0.535	9	120	0.833	56%	0.666	14	120	0.795	19%
			0.493	9	120	0.833	69%	0.625	14	120	0.795	27%

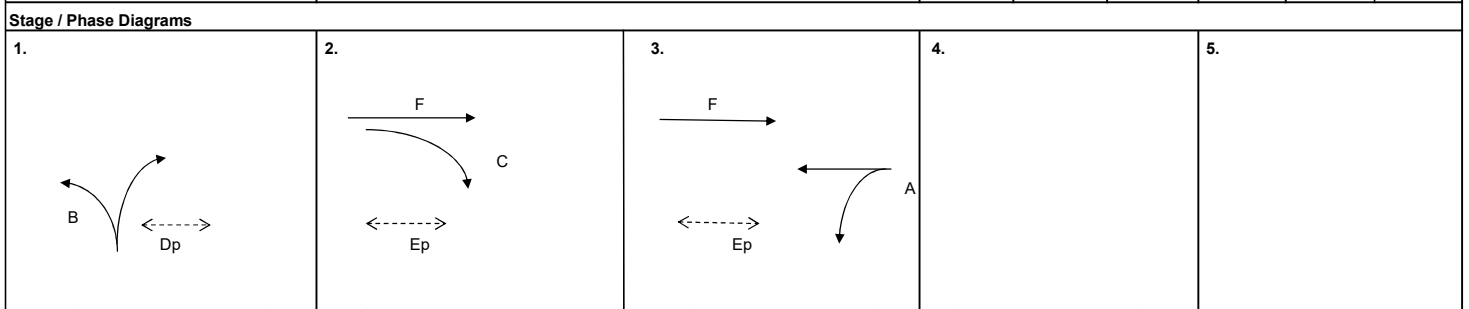

I/G= 6		I/G= 5		I/G= 6		I/G=		I/G=	
I/G= 6		I/G= 5		I/G= 6		I/G=		I/G=	
Date: APR, 2022								Junction: <span style="border: 1px solid black; border-radius: 50%; padding: 2px;">J5</span>	
								Castle Peak Road - Hung Shui Kiu / Shun Tat Street	

# Priority Junction Capacity Calculation



Job Title: CE 92/2017 (CE) Site Formation and Infrastructure Works for Development near Tan Kwai Tsuen, Yuen Long - IDC		Designed by: HWL
Junction: Shun Tat Street - Tat Fuk Road (J6)		Checked by: TKM
Scheme: Design Weekday AM/ PM Peak		Date: Apr-22
Design Year: 2030	Job No.: CHK50637810	
Arm A: Shun Tat Street (WB)		
Arm B: Tat Fuk Road (NB)		
Arm C: Shun Tat Street (EB)		
Arm D: Tat Fuk Road (SB)		

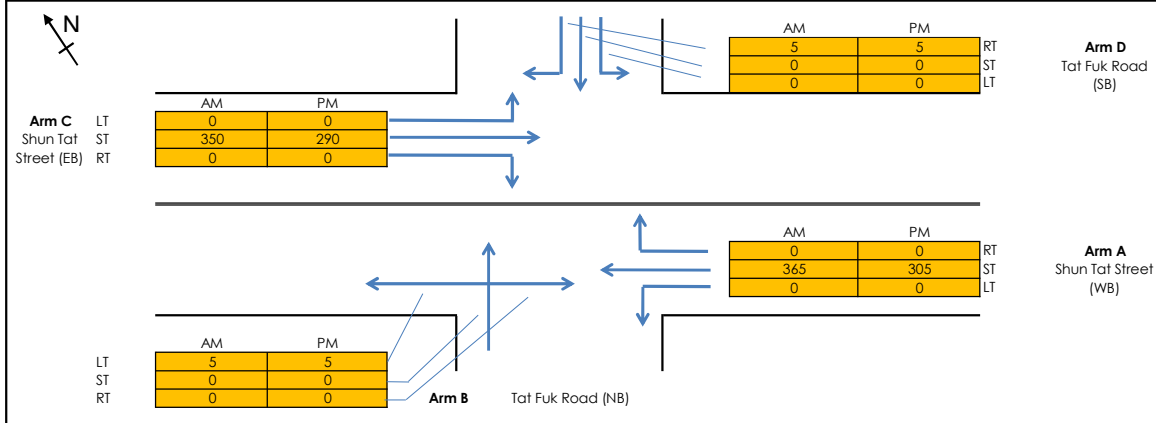

## GEOMETRY

Major Road Width (m)	W	10.00
Central Reserve Width (m)	Wcr	0.00

PARAMETER		Arm B		Arm D					
Lane widths (m)	w(b-a)	3.00	Blockage of major road RT (c-b block c-a)?	Y	Y				
	w(b-c)	3.00							
	w(c-b)	4.50							
Visibility Distances (m)	Vr(b-a)	30	Calculated Parameters	D	0.867				
	VI(b-a)	120				E	0.880		
	Vr(b-c)	50						F	1.060
	Vr(c-b)	100							
Straight ahead movement using left lane?		Y	Straight ahead movement using left lane?		Y				

## ANALYSIS

		AM Peak	PM Peak			AM Peak	PM Peak
TRAFFIC FLOWS (pcu/hr)	q(a-b)	0	0	q(c-d)	0	0	
	q(a-c)	365	305	q(c-a)	350	290	
	q(a-d)	0	0	q(c-b)	0	0	
	q(c-a)	350	290	q(a-c)	365	305	
	q(c-b)	0	0	q(a-d)	0	0	
	q(c-d)	0	0	q(a-b)	0	0	
	q(d-a)	0	0	q(b-c)	5	5	
	q(d-b)	0	0	q(b-d)	0	0	
	q(d-c)	5	5	q(b-a)	0	0	
	q(b-a)	0	0	q(d-c)	5	5	
	q(b-d)	0	0	q(d-b)	0	0	
	q(b-c)	5	5	q(d-a)	0	0	
Left turn proportion	F	1.00	1.00	Left turn proportion	F	0.00	0.00

CAPACITIES (pcu/hr)		AM Peak	PM Peak	CAPACITIES (pcu/hr)		AM Peak	PM Peak
Q(b-ad)		417	437	Q(d-bc)		423	443
Q(b-acd)		579	591	Q(d-abc)		423	443
Q(c-b)		698	713	Q(a-d)		676	690
Q(c-a)		1800	1800	Q(a-c)		1800	1800

RFC's		AM Peak	PM Peak	RFC's		AM Peak	PM Peak
c-b		0.00	0.00	a-d		0.00	0.00
c-a		0.19	0.16	a-c		0.20	0.17
b-acd		0.01	0.01	d-acd		0.01	0.01

## RFC

		<b>0.19</b>	<b>0.16</b>			<b>0.20</b>	<b>0.17</b>
--	--	-------------	-------------	--	--	-------------	-------------

Where VI and Vr are visibility distances to the left or right of the respective streams  
 $D = (1 + 0.094(w(b-a) - 3.65)) (1 + 0.0009(Vr(b-a) - 120)) (1 + 0.0006(VI(b-a) - 150))$   
 $E = (1 + 0.094(w(b-c) - 3.65)) (1 + 0.0009(Vr(b-c) - 120))$   
 $F = (1 + 0.094(w(c-b) - 3.65)) (1 + 0.0009(Vr(c-b) - 120))$   
 $Y = 1 - 0.0345W$   
 F = proportion of minor traffic turning left  
 $Q(b-ad) = Q(b-a) * Q(b-d) / (0.5 * Q(b-a) + 0.5 * Q(b-d))$  Capacity of combined streams  
 $Q(b-acd) = Q(b-c) * Q(b-ad) / ((1-F) * Q(b-c) + F * Q(b-ad))$  Capacity of combined streams

All the above formulas are in accordance to T.P.D.M. Vol.2 Chapter 4 Appendix 1

**TRAFFIC SIGNALS CALCULATION**

Job No.: **CHK50637810**

**MVA HONG KONG LIMITED**

Junction: Shun Tat Street / Tung Fuk Road

Design Year: 2030

Description: Design Weekday AM/ PM Peak (Proposed Future Layout)

Designed By: HWL

Checked By: TKM

Approach	Movements	Phase	Stage	Width (m)	Radius (m)		Gradient (%)	Pro. Turning (%)		Revised Saturation Flow (pcu/hr)		AM Peak			PM Peak		
					Left	Right		AM	PM	AM	PM	Flow (pcu/hr)	y Value	Critical y	Flow (pcu/hr)	y Value	Critical y
Shun Tat Street EB	↔	A	1	3.100	12.5					1720	1720	255	0.148	0.148	215	0.125	0.125
	↕	A	1	3.100		7.5		16%	15%	2000	2005	95	0.048		65	0.032	
Access Road SB	↕↔	B	2	4.000	10	20		0% / 100%	0% / 100%	1875	1875	300	0.160	0.160	245	0.131	0.131
Local Road WB	↕↔	C	4	3.500		15		0%	0%	1965	1965	5	0.003		5	0.003	
Tung Fuk Road NB	↔↕	D	5	3.000	7.5	15		100% / 0%	100% / 0%	1595	1595	5	0.003		5	0.003	
	↕	F	3	6.000		8		0%	0%	2215	2215	65	0.029		65	0.029	
Pedestrian Crossing		Ep	3,4	MIN GREEN + FLASH =			5	+	9	=	14						

<b>Notes:</b>	<b>Flow: (pcu/hr)</b>		<b>Group</b>		A,B,Ep,D	A,B,F,C,D	<b>Group</b>	A,B,Ep,D	A,B,F,C,D
			<b>y</b>	0.308	0.308	<b>y</b>	0.256	0.256	
	<b>L (sec)</b>	45	47	<b>L (sec)</b>	45	47			
	<b>C (sec)</b>	90	90	<b>C (sec)</b>	90	90			
	<b>y pract.</b>	0.450	0.430	<b>y pract.</b>	0.450	0.430			
	<b>R.C. (%)</b>	46%	39%	<b>R.C. (%)</b>	76%	68%			

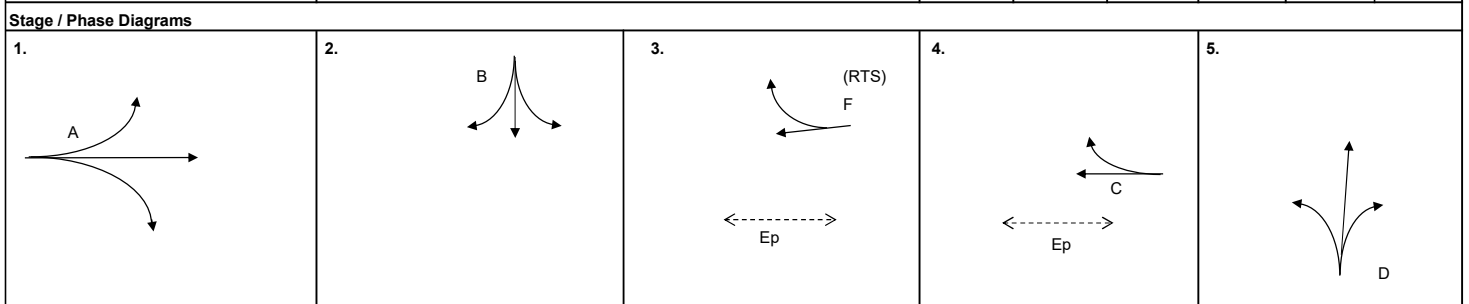

I/G= 7	I/G= 7	I/G= 6	5	I/G= 5	5	I/G= 9	5
I/G= 7	I/G= 7	I/G= 6	5	I/G= 5	5	I/G= 9	5
<b>Date:</b> APR, 2022						<b>Junction:</b> Shun Tat Street / Tung Fuk Road	

(J7)

**TRAFFIC SIGNALS CALCULATION**

Job No.: **CHK50637810**

**MVA HONG KONG LIMITED**

Junction: Castle Peak Road - Hung Shui Kiu / Fuk Hang Tsuen Road

Design Year: 2030

Description: Design Weekday AM/ PM Peak (Proposed CE2 2011 Layout)

Designed By: HWL

Checked By: TKM

Approach	Movements	Phase	Stage	Width (m)	Radius (m)		Gradient (%)	Pro. Turning (%)		Revised Saturation Flow (pcu/hr)		AM Peak			PM Peak		
					Left	Right		AM	PM	AM	PM	Flow (pcu/hr)	y Value	Critical y	Flow (pcu/hr)	y Value	Critical y
Castle Peak Rd	→	E	1	3.250						2080	2080	873	0.420	0.420	888	0.427	0.427
Hung Shui Kiu	→	E	1	3.250						2080	2080	872	0.419		887	0.426	
EB	↓	P	2	3.000		15				1740	1740	215	0.124		215	0.124	
Castle Peak Rd	↔	F	1	3.750	15			15%	16%	1960	1960	479	0.244		479	0.244	
Hung Shui Kiu	←	F	1	3.750						2130	2130	521	0.245		521	0.245	
WB	←	F	1	3.750						2130	2130	520	0.244		520	0.244	
Fuk Hang Tsuen Road (NB)	↕	K	3	3.300	12.5	10		88% / 13%	85% / 15%	1730	1730	320	0.185	0.185	260	0.150	0.150
Pedestrian Crossing		Hp	2	MIN GREEN + FLASH =		10	+	10	=	20				*			*
		Gp	2,3	MIN GREEN + FLASH =		10	+	10	=	20							

Notes:	Flow: (pcu/hr)	Group	E,P,K	E,Hp,K	Group	E,P,K	E,Hp,K
		y	0.728	0.605	y	0.701	0.577
		L (sec)	15	34	L (sec)	15	34
		C (sec)	100	100	C (sec)	100	100
		y pract.	0.765	0.594	y pract.	0.765	0.594
		R.C. (%)	5%	-2%	R.C. (%)	9%	3%

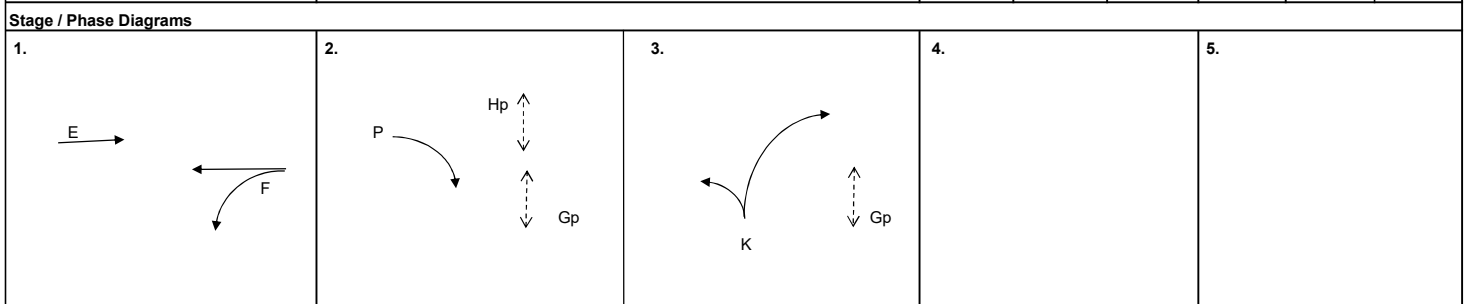

I/G= 7		I/G= 7	20	I/G= 2		I/G=		I/G=	
I/G= 7		I/G= 7	20	I/G= 2		I/G=		I/G=	
<b>Date:</b> APR, 2022								<b>Junction:</b> Castle Peak Road - Hung Shui Kiu / Fuk Hang Tsuen Road	

**TRAFFIC SIGNALS CALCULATION**

Job No.: **CHK50637810**

**MVA HONG KONG LIMITED**

Junction: Castle Peak Road - Hung Shui Kiu / Fuk Hang Tsuen Rd

Design Year: 2030

Description: Design Weekday AM/ PM Peak (Proposed Further Improvement Scheme)

Designed By: HWL

Checked By: TKM

Approach	Movements	Phase	Stage	Width (m)	Radius (m)		Gradient (%)	Pro. Turning (%)		Revised Saturation Flow (pcu/hr)		AM Peak			PM Peak		
					Left	Right		AM	PM	AM	PM	Flow (pcu/hr)	y Value	Critical y	Flow (pcu/hr)	y Value	Critical y
Castle Peak Rd	→	E	1,4	3.250						2080	2080	873	0.420	0.420	888	0.427	0.427
Hung Shui Kiu	→	E	1,4	3.250						2080	2080	872	0.419		887	0.426	
EB	↓	P	2	3.000		15				1870	1870	215	0.115	0.115	215	0.115	0.115
Castle Peak Rd	↔	F	1	3.500	15			15%	16%	1935	1935	479	0.248		479	0.248	
Hung Shui Kiu	←	F	1	3.500						2105	2105	521	0.248		521	0.248	
WB	←	F	1	3.500						2105	2105	520	0.247		520	0.247	
Fuk Hang Tsuen Road (NB)	↕	K	3	3.300	15					1770	1770	154	0.087		125	0.071	
	↕	K	3	3.300	17.5	12.5		76% / 24%	70% / 30%	1905	1905	166	0.087	0.087	135	0.071	0.071
Pedestrian Crossing		Hp	2	MIN GREEN + FLASH =		10	+	10	=	20							
		Gp	2,3	MIN GREEN + FLASH =		10	+	10	=	20							
		lp	4	MIN GREEN + FLASH =		5	+	14	=	19							

<b>Notes:</b>	<b>Flow: (pcu/hr)</b>			<b>Group</b>	E, Hp, K	E, P, K	<b>Group</b>	F, P, K, lp	E, P, K
		<b>y</b>	0.507	0.622	<b>y</b>	0.433	0.613		
		<b>L (sec)</b>	30	13	<b>L (sec)</b>	38	13		
		<b>C (sec)</b>	120	120	<b>C (sec)</b>	120	120		
		<b>y pract.</b>	0.675	0.803	<b>y pract.</b>	0.615	0.803		
		<b>R.C. (%)</b>	33%	29%	<b>R.C. (%)</b>	42%	31%		

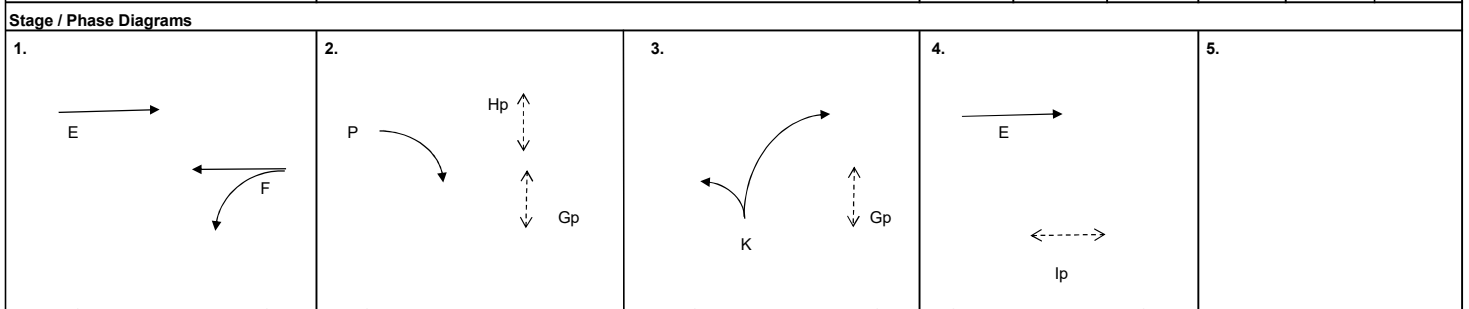

I/G=		I/G= 5		I/G= 6		I/G= 5		I/G=	
I/G=		I/G= 5		I/G= 6		I/G= 5		I/G=	
<b>Date:</b> APR, 2022							<b>Junction:</b> Castle Peak Road - Hung Shui Kiu / Fuk Hang Tsuen Rd		

**TRAFFIC SIGNALS CALCULATION**

Job No.: **CHK50637810**

**MVA HONG KONG LIMITED**

Junction: Castle Peak Road - Hung Tin Road

Design Year: 2030

Description: Design Weekday AM/ PM Peak

Designed By: HWL

Checked By: TKM

Approach	Movements	Phase	Stage	Width (m)	Radius (m)		Gradient (%)	Pro. Turning (%)		Revised Saturation Flow (pcu/hr)		AM Peak			PM Peak		
					Left	Right		AM	PM	AM	PM	Flow (pcu/hr)	y Value	Critical y	Flow (pcu/hr)	y Value	Critical y
Hung Tin Road SB	L	F	2	3.300	12.5					1735	1735	100	0.058		75	0.043	
	↕	F	2	3.500	15	15	0% / 100%	0% / 100%	1915	1915	232	0.121		197	0.103		
	↕	F	2	3.500		12.5			1880	1880	228	0.121		193	0.103		
Castle Peak Road	↖	C	2,3	3.300	22.5					1825	1825	470	0.258	0.258	420	0.230	0.230
Hung Shui Kiu	→	B	3,4	3.650						1980	1980	244	0.123		268	0.135	
EB	→	B	3,4	3.650						2120	2120	261	0.123		287	0.135	
Castle Peak Road	←	D	1,3,4	3.650						1980	1980	365	0.184		299	0.151	
Hung Shui Kiu	←	D	1,3,4	3.650						2120	2120	390	0.184		321	0.151	
WB	↖	E	1	3.400		15				1905	1905	405	0.213	0.213	345	0.181	0.181
LRT (FIXED TIME)		A	4	MIN GREEN + (FLASH + /			20	+	16	=	36			*			*
Pedestrian Crossing	Gp	1	MIN GREEN + FLASH =			5	+	9	=	14							
	Hp	1,2,3	MIN GREEN + FLASH =			5	+	8	=	13							
	lp	1,3,4	MIN GREEN + FLASH =			5	+	9	=	14							
	Jp	4	MIN GREEN + FLASH =			7	+	14	=	21							
	Kp	2	MIN GREEN + FLASH =			8	+	7	=	15							

Notes:	Flow: (pcu/hr)	Group	E,F,Hp,A	E,C,A	Group	E,F,Hp,A	E,C,A
		<b>y</b>	0.334	0.470	<b>y</b>	0.284	0.411
		<b>L (sec)</b>	59	51	<b>L (sec)</b>	57	49
		<b>C (sec)</b>	130	130	<b>C (sec)</b>	130	130
		<b>y pract.</b>	0.492	0.547	<b>y pract.</b>	0.505	0.561
		<b>R.C. (%)</b>	47%	16%	<b>R.C. (%)</b>	78%	36%

Stage / Phase Diagrams							
1.	2.	3.	4.				
I/G= 2	I/G= 9	I/G=	I/G= 6	36	I/G=		
I/G=	I/G= 9	I/G=	I/G= 6	36	I/G=		

Date: **APR, 2022** Junction: **Castle Peak Road - Hung Tin Road** (J9)



## Priority Junction Capacity Calculation

Job Title: CE 92/2017 (CE) Site Formation and Infrastructure Works for Development near Tan Kwai Tsuen, Yuen Long - IDC		Designed by: HWL
Junction: Tan Kwai Tsuen Road - Shui Fu Road (J10)		Checked by: TKM
Scheme: Design Weekday AM/ PM Peak		Date: Apr-22
Design Year: 2030	Job No.: CHK50637810	
Arm A: Tan Kwai Tsuen Road (SB)		
Arm B: Shui Fu Road		
Arm C: Tan Kwai Tsuen Road (NB)		

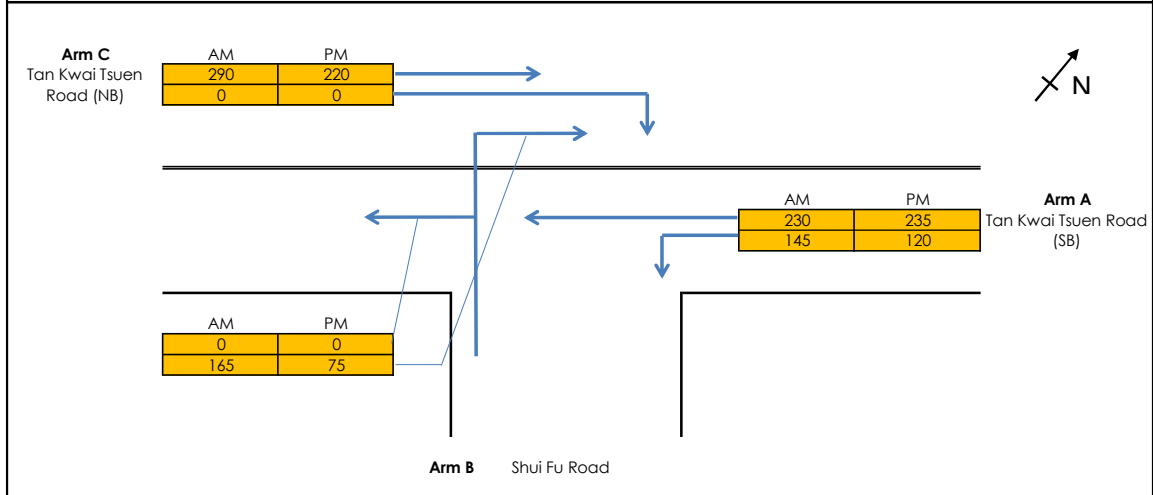

### GEOMETRY

Major Road Width (m)	W	7.25	Lane widths (m)	w(b-a)	3.00
Central Reserve Width (m)	Wcr	0.00		w(b-c)	3.00
Blockage of major road right turn	Y/N?	Y		w(c-b)	3.50
Combined stream on minor arm	Y/N?	Y			
Visibility Distances (m)	Vr(b-a)	80	Calculated Parameters	D	0.867
	VI(b-a)	80		E	0.905
	Vr(b-c)	80		F	0.933
	Vr(c-b)	60		Y	0.75

### ANALYSIS

		AM	PM
TRAFFIC FLOWS (pcu/hr)	q(c-a)	290	220
	q(c-b)	0	0
	q(a-b)	145	120
	q(a-c)	230	235
	q(b-a)	165	75
	q(b-c)	0	0
	f	0.00	0.00
CAPACITIES (pcu/hr)	Q(b-ac)	432	444
	Q(c-a)	1800	1800
	Q(c-b)	599	604
RFC's	c-a	0.16	0.12
	c-b	0.00	0.00
	b-ac	0.38	0.17
<b>RFC</b>		<b>0.38</b>	<b>0.17</b>

Where VI and Vr are visibility distances to the left or right of the respective streams  
 $D = (1 + 0.094(w(b-a) - 3.65))(1 + 0.0009(Vr(b-a) - 120))(1 + 0.0006(VI(b-a) - 150))$   
 $E = (1 + 0.094(w(b-c) - 3.65))(1 + 0.0009(Vr(b-c) - 120))$   
 $F = (1 + 0.094(w(c-b) - 3.65))(1 + 0.0009(Vr(c-b) - 120))$   
 $Y = 1 - 0.0345W$   
 f = proportion of minor traffic turning left  
 $Q(b-ac) = Q(b-c) * Q(b-a) / (1 - f) * Q(b-c) + f * Q(b-a)$  Capacity of combined streams

All the above formulas are in accordance to T.P.D.M. V.2.4 Appendix 1

**TRAFFIC SIGNALS CALCULATION**

Job No.: **CHK50637810**

**MVA HONG KONG LIMITED**

Junction: Shui Fu Road / Proposed Access Road

Design Year: 2030

Description: Design Weekday AM/ PM Peak

Designed By: HWL

Checked By: TKM

Approach	Movements	Phase	Stage	Width (m)	Radius (m)		Gradient (%)	Pro. Turning (%)		Revised Saturation Flow (pcu/hr)		AM Peak			PM Peak		
					Left	Right		AM	PM	AM	PM	Flow (pcu/hr)	y Value	Critical y	Flow (pcu/hr)	y Value	Critical y
Access Road (WB)	↓	B	2	4.500	7.5			0%	0%	2065	2065	5	0.002		5	0.002	
Access Road (EB)	↗	A	1	5.000	18			100%	100%	1950	1950	155	0.079	0.079	75	0.038	0.038
Shui Fu Road (Lower section)	↔	C	3	5.000	22.5	15		100% / 0%	100% / 0%	1985	1985	150	0.076	0.076	125	0.063	0.063
Shui Fu Road (Upper section)	↔	D	4	5.000	22.5	12.5		0% / 100%	0% / 100%	1890	1890	10	0.005		5	0.003	
Pedestrian Crossing		Ep	5	MIN GREEN + FLASH =		7	+	9	=	16							*
		Fp	5	MIN GREEN + FLASH =		7	+	9	=	16							*

Notes:	Flow: (pcu/hr)		Group	A,B,C,D,Ep	A,B,C,D,Ep	Group	A,B,C,D,Ep	A,B,C,D,Ep
						y	0.155	0.155
			L (sec)	59	59	L (sec)	59	59
			C (sec)	100	100	C (sec)	100	100
			y pract.	0.369	0.369	y pract.	0.369	0.369
			R.C. (%)	138%	138%	R.C. (%)	264%	264%

Stage / Phase Diagrams									
1.	2.	3.	4.	5.					
I/G= 7	I/G= 7	I/G= 7	I/G= 7	I/G= 7	I/G= 7	I/G= 7	I/G= 7	I/G= 7	I/G= 7
I/G= 7	I/G= 7	I/G= 7	I/G= 7	I/G= 7	I/G= 7	I/G= 7	I/G= 7	I/G= 7	I/G= 7

Date: **APR, 2022** Junction: **Shui Fu Road / Proposed Access Road** (J12)

# 2034 Reference Junction Calculations

## TRAFFIC SIGNALS CALCULATION

Job No.: **CHK50637810**

MVA HONG KONG LIMITED

Junction: Hung Tin Road / Hung Chi Road

Design Year: 2034

Description: Reference Weekday AM/PM Peak

Designed By: HWL

Checked By: TKM

Approach	Movements	Phase	Stage	Width (m)	Radius (m)		Gradient (%)	Pro. Turning (%)		Revised Saturation Flow (pcu/hr)		AM Peak			PM Peak		
					Left	Right		AM	PM	AM	PM	Flow (pcu/hr)	y Value	Critical y	Flow (pcu/hr)	y Value	Critical y
Hung Tin Road NB	↕	G	4	3.400	12.5			100%	100%	1745	1745	695	0.398	0.398	725	0.415	0.415
	↗	G	4	3.400		12.5		65%	73%	1945	1925	723	0.372		709	0.368	
	↘	G	4	3.400		10				1820	1820	677	0.372		671	0.369	
Hung Chi Road EB	↔	H	1	3.500	12.5			57%	64%	1840	1825	70	0.038		47	0.026	
	→	H	1	3.500						2105	2105	80	0.038		54	0.026	
	→	H	1	3.500						2105	2105	80	0.038		54	0.026	
Shek Po East Rd SB	↕	I	3	4.500	12.5					1845	1845	75	0.041	0.041	50	0.027	
HSK Interchange EB	↔	A	1,4	3.400						1955	1955	185	0.095		160	0.082	
	↘	B	4	3.400		20				1950	1950	620	0.318		625	0.321	
	↘	B	4	3.400		15				1905	1905	605	0.318		610	0.320	
HSK Interchange WB	↔	F	2	3.500		15				1915	1915	30	0.016		40	0.021	
	←	E	1,2	3.300						1945	1945	85	0.044		60	0.031	
Hung Tin Road SB	↕	C	4	3.400	10			16%	13%	1910	1915	160	0.084	0.084	112	0.058	
	↘	C	4	3.400						2095	2095	175	0.084		123	0.059	0.059
	↘	C	4	3.400		17.5				1930	1930	75	0.039		45	0.023	
Hung Chi Road WB	←	D	1	3.500						2105	2105	40	0.019		55	0.026	
	↘	D	1	3.500	10					1710	1710	80	0.047	0.047	120	0.070	0.070
Pedestrian Crossing	Jp	3,4	MIN GREEN + FLASH =		7	+	10	=	17								
	Kp	3	MIN GREEN + FLASH =		6	+	6	=	12								
	Lp	2,3,4	MIN GREEN + FLASH =		6	+	6	=	12								
	Mp	3	MIN GREEN + FLASH =		7	+	9	=	16								
	Np	1,2,3	MIN GREEN + FLASH =		7	+	10	=	17								
	Op	3	MIN GREEN + FLASH =		6	+	6	=	12								
	Pp	2,3,4	MIN GREEN + FLASH =		7	+	9	=	16								

Notes:	Traffic Flow (pcu/hr)	Group	H.C.I,G	D.C.I,G	Group	H.C.I,G	D.C.I,G
		<b>y</b>	0.561	0.569	<b>y</b>	0.474	0.544
		<b>L (sec)</b>	22	21	<b>L (sec)</b>	34	27
		<b>C (sec)</b>	120	120	<b>C (sec)</b>	120	120
		<b>y pract.</b>	0.735	0.743	<b>y pract.</b>	0.645	0.698
		<b>R.C. (%)</b>	31%	30%	<b>R.C. (%)</b>	36%	28%

Stage / Phase Diagrams							
1.	2.	3.	4.	5.			
I/G= 6	I/G= 6	I/G= 6	I/G= 7	I/G=			
I/G= 6	I/G= 6	I/G= 6	I/G= 7	I/G=			

Date: JUN, 2022 Junction: Hung Tin Road / Hung Chi Road (J1)

**TRAFFIC SIGNALS CALCULATION**

Job No.: CHK50637810

MVA HONG KONG LIMITED

Junction: Castle Peak Road - Hung Shui Kiu / Hung Tak Road

Design Year: 2034

Description: Reference Weekday AM/ PM Peak (TD Improvement Scheme)

Designed By: HWL

Checked By: TKM

Approach	Movements	Phase	Stage	Width (m)	Radius (m)		Gradient (%)	Pro. Turning (%)		Revised Saturation Flow (pcu/hr)		AM Peak			PM Peak		
					Left	Right		AM	PM	AM	PM	Flow (pcu/hr)	y Value	Critical y	Flow (pcu/hr)	y Value	Critical y
Castle Peak Road - Hung Shui Kiu WB	↙	C	2	3.300	15					1770	1770	320	0.181		235	0.133	0.133
	←	D	1	3.300						2085	2085	360	0.173	0.173	303	0.145	0.145
	←	D	1	3.300						2085	2085	360	0.173		302	0.145	
Hung Tak Road NB	**↑*	B	2	3.500	10	15		16% / 84%	13% / 87%	1920	1920	350	0.182	0.182	195	0.102	
Castle Peak Road - Hung Shui Kiu EB	*→	A	1	3.300						1750	1750	205	0.117		241	0.138	
	→	A	1	3.300						2085	2085	245	0.118		287	0.138	
	→	A	1	3.300						2085	2085	245	0.118		287	0.138	
Pedestrian Crossing	Ep	1,3		MIN GREEN + FLASH =		5	+	7	=	12							
	Fp	1,3		MIN GREEN + FLASH =		5	+	6	=	11							
	Gp	3		MIN GREEN + FLASH =		10	+	8	=	18			*				*

Notes:	Flow: (pcu/hr)	Group	D,C,Gp	D,B,Gp	Group	A,C,Gp	D,C,Gp
* Site factor = 0.9 is used (Effect of bus stop situated at Castle Peak Road - Hung Shui Kiu EB)		<b>y</b>	0.353	0.355	<b>y</b>	0.270	0.278
** Saturation flow at Hung Tak Road increased		<b>L (sec)</b>	27	30	<b>L (sec)</b>	28	27
		<b>C (sec)</b>	90	90	<b>C (sec)</b>	90	90
		<b>y pract.</b>	0.630	0.600	<b>y pract.</b>	0.620	0.630
		<b>R.C. (%)</b>	78%	69%	<b>R.C. (%)</b>	129%	127%

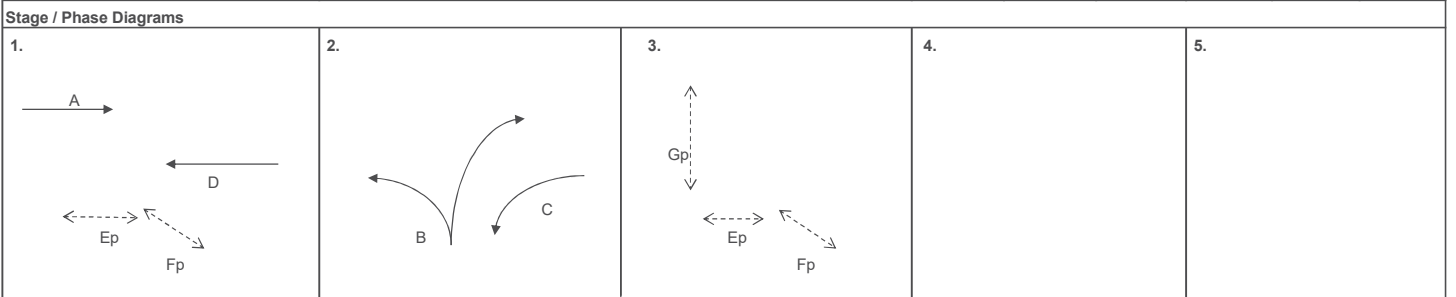

I/G= 2		I/G= 5		I/G= 7	18	I/G=		I/G=	
I/G= 2		I/G= 5		I/G= 4	18	I/G=		I/G=	
Date: JUN, 2022								Junction: Castle Peak Road - Hung Shui Kiu / Hung Tak Road (J2)	

**TRAFFIC SIGNALS CALCULATION**

Job No.: **CHK50637810**

**MVA HONG KONG LIMITED**

Junction: Castle Peak Road - Hung Shui Kiu/ Tan Kwai Tsuen Road

Design Year: 2034

Description: Reference Weekday AM/ PM Peak (TD Improvement Scheme)

Designed By: HWL

Checked By: TKM

Approach	Movements	Phase	Stage	Width (m)	Radius (m)		Gradient (%)	Pro. Turning (%)		Revised Saturation Flow (pcu/hr)		AM Peak			PM Peak		
					Left	Right		AM	PM	AM	PM	Flow (pcu/hr)	y Value	Critical y	Flow (pcu/hr)	y Value	Critical y
Castle Peak Rd Hung Shui Kiu WB	→ → ↘	I I H	1,2 1,2 2	3,300 3,300 3,300						1945 2085 1985	1945 2085 1985	292 313 225	0.150 0.150 0.113	0.113	355 380 225	0.183 0.182 0.113	0.113
Castle Peak Rd Hung Shui Kiu EB	← ←	G G	1 1	3,650 3,650						1980 2120	1980 2120	374 401	0.189 0.189	0.189	304 326	0.154 0.154	0.154
Tan Kwai Tsuen Road NB	↗	F	3	4,000	15	17.5		73% / 27%	73% / 27%	1840	1840	330	0.179	0.179	295	0.160	0.160
Pedestrian Crossing		Jp	1	MIN GREEN + FLASH =			10	+	7	=	17						

<b>Notes:</b>	<b>Flow: (pcu/hr)</b>			<b>Group</b>	Jp,H,F	G,H,F	<b>Group</b>	Jp,H,F	G,H,F
				<b>y</b>	0.293	0.482	<b>y</b>	0.274	0.427
				<b>L (sec)</b>	29	19	<b>L (sec)</b>	29	19
				<b>C (sec)</b>	90	90	<b>C (sec)</b>	90	90
				<b>y pract.</b>	0.610	0.710	<b>y pract.</b>	0.610	0.710
				<b>R.C. (%)</b>	108%	47%	<b>R.C. (%)</b>	123%	66%

<b>Stage / Phase Diagrams</b>									
1. 	2. 	3. 	4.	5.					
I/G= 6	I/G= 7	I/G= 9	I/G=	I/G=					
I/G= 6	I/G= 7	I/G= 9	I/G=	I/G=					

Date: JUN, 2022 Junction: Castle Peak Road / Tan Kwai Tsuen Road (MN37) (J3)

## Priority Junction Capacity Calculation

Job Title: CE 92/2017 (CE) Site Formation and Infrastructure Works for Development near Tan Kwai Tsuen, Yuen Long - IDC	Designed by: HWL
Junction: Tan Kwai Tsuen Road - Hung Shun Road (J4)	Checked by: TKM
Scheme: Reference Weekday AM/ PM Peak	Date: Jun-22
Design Year: 2034	Job No.: CHK50637810
Arm A: Tan Kwai Tsuen Road (SB)	
Arm B: Hung Shun Road	
Arm C: Tan Kwai Tsuen Road (NB)	

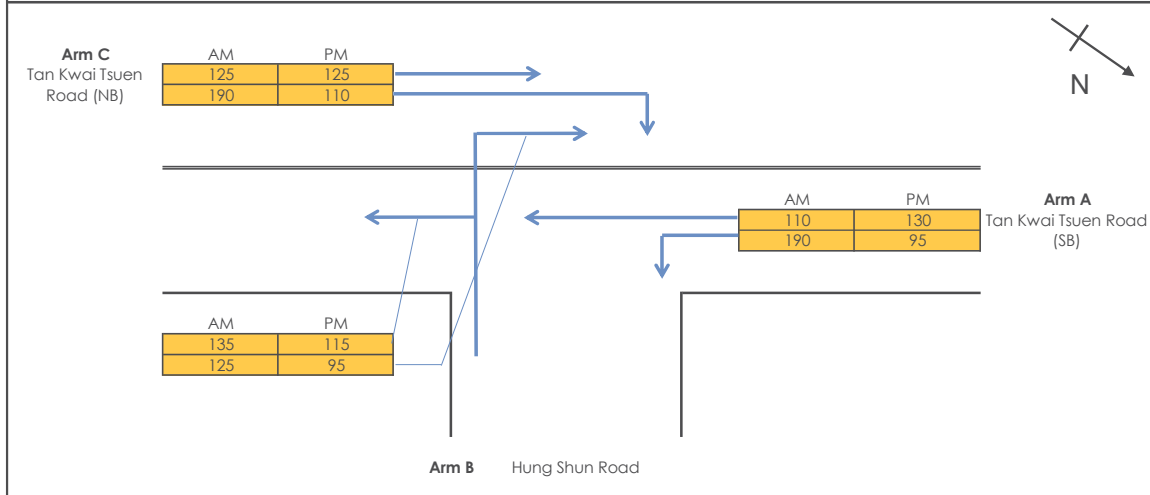

### GEOMETRY

Major Road Width (m)	W	8.00	Lane widths (m)	w(b-a)	3.50
Central Reserve Width (m)	Wcr	0.00		w(b-c)	3.50
Blockage of major road right turn	Y/N?	Y		w(c-b)	3.50
Combined stream on minor arm	Y/N?	Y			
Visibility Distances (m)	Vr(b-a)	60	Calculated Parameters	D	0.863
	VI(b-a)	25		E	0.942
	Vr(b-c)	70		F	0.968
	Vr(c-b)	100		Y	0.724

### ANALYSIS

		AM	PM
TRAFFIC FLOWS (pcu/hr)	q(c-a)	125	125
	q(c-b)	190	110
	q(a-b)	190	95
	q(a-c)	110	130
	q(b-a)	125	95
	q(b-c)	135	115
	f	0.52	0.55
CAPACITIES (pcu/hr)	Q(b-ac)	516	544
	Q(c-a)	1269.55	1502
	Q(c-b)	645	664
RFC's	c-a	0.10	0.08
	c-b	0.29	0.17
	b-ac	0.50	0.39
<b>RFC</b>		<b>0.50</b>	<b>0.39</b>

Where VI and Vr are visibility distances to the left or right of the respective streams  
 $D = (1 + 0.094(w(b-a) - 3.65))(1 + 0.0009(Vr(b-a) - 120))(1 + 0.0006(VI(b-a) - 150))$   
 $E = (1 + 0.094(w(b-c) - 3.65))(1 + 0.0009(Vr(b-c) - 120))$   
 $F = (1 + 0.094(w(c-b) - 3.65))(1 + 0.0009(Vr(c-b) - 120))$   
 $Y = 1 - 0.0345W$

f = proportion of minor traffic turning left  
 $Q(b-ac) = Q(b-c) * Q(b-a) / (1-f) * Q(b-c) + f * Q(b-a)$  Capacity of combined streams

All the above formulas are in accordance to T.P.D.M. V.2.4 Appendix 1

**TRAFFIC SIGNALS CALCULATION**

Job No.: CHK50637810

MVA HONG KONG LIMITED

Junction: Castle Peak Road - Hung Shui Kiu / Shun Tat Street

Design Year: 2034

Description: Reference Weekday AM/ PM Peak (TD Improvement Scheme)

Designed By: HWL

Checked By: TKM

Approach	Movements	Phase	Stage	Width (m)	Radius (m)		Gradient (%)	Pro. Turning (%)		Revised Saturation Flow (pcu/hr)		AM Peak			PM Peak		
					Left	Right		AM	PM	AM	PM	Flow (pcu/hr)	y Value	Critical y	Flow (pcu/hr)	y Value	Critical y
Castle Peak Rd	→	F	1	3.500						2105	2105	644	0.306	0.306	670	0.318	0.318
Hung Shui Kiu EB	↕	C	1	3.500		20		16%	20%	2080	2075	636	0.306		660	0.318	
Castle Peak Road	↕	A	3	3.800	15			30%	24%	1935	1950	402	0.208	0.208	475	0.244	0.244
Hung Shui Kiu WB	←	A	3	3.800						2135	2135	443	0.207		520	0.244	
Shun Tat Street NB	↕	B	2	4.000	12.5	17.5		74% / 26%	74% / 26%	1815	1815	235	0.129	0.129	210	0.116	0.116
Pedestrian Crossing		Dp	2	MIN GREEN + FLASH =		7	+	10	=	17							
		Ep	1,3	MIN GREEN + FLASH =		6	+	6	=	12							

Notes:	Flow: (pcu/hr)	Group	C,Dp,A	F,B,A	Group	C,Dp,A	F,B,A
		<b>y</b>	0.514	0.643	<b>y</b>	0.562	0.678
		<b>L (sec)</b>	30	14	<b>L (sec)</b>	30	14
		<b>C (sec)</b>	120	120	<b>C (sec)</b>	120	120
		<b>y pract.</b>	0.675	0.795	<b>y pract.</b>	0.675	0.795
		<b>R.C. (%)</b>	31%	24%	<b>R.C. (%)</b>	20%	17%

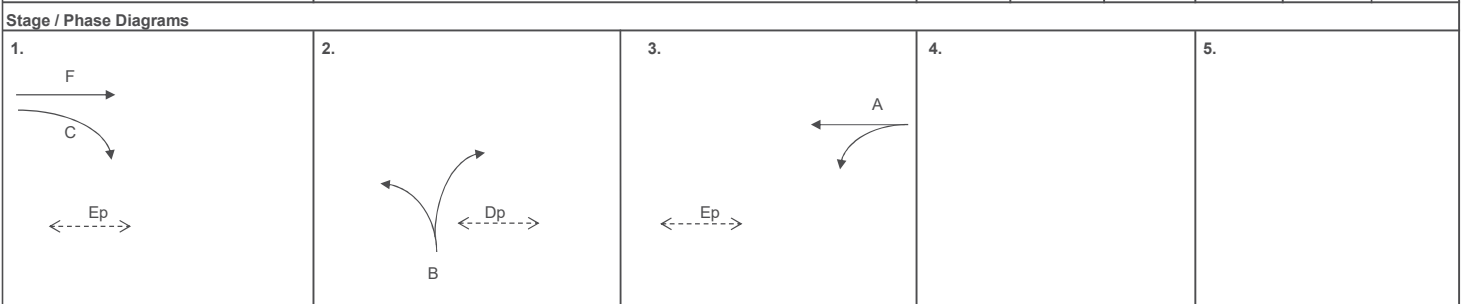

I/G= 5	I/G= 6	I/G= 6	I/G= 6	I/G=	I/G=
I/G= 5	I/G= 6	I/G= 6	I/G= 6	I/G=	I/G=
<b>Date:</b> JUN, 2022				<b>Junction:</b> Castle Peak Road - Hung Shui Kiu / Shun Tat Street	

(J5)

**TRAFFIC SIGNALS CALCULATION**

Job No.: CHK50637810

MVA HONG KONG LIMITED

Junction: Castle Peak Road - Hung Shui Kiu / Shun Tat Street

Design Year: 2034

Description: Reference Weekday AM/ PM Peak (Proposed Further Improvement Scheme)

Designed By: HWL

Checked By: TKM

Approach	Movements	Phase	Stage	Width (m)	Radius (m)		Gradient (%)	Pro. Turning (%)		Revised Saturation Flow (pcu/hr)		AM Peak			PM Peak		
					Left	Right		AM	PM	AM	PM	Flow (pcu/hr)	y Value	Critical y	Flow (pcu/hr)	y Value	Critical y
Castle Peak Rd	→	F	2,3	3,300						1945	1945	570	0.293	0.293	579	0.298	
Hung Shui Kiu	→	F	2,3	3,300						2085	2085	610	0.293		621	0.298	
EB	↓	C	2	3,300		15				1895	1895	100	0.053		130	0.069	0.069
Castle Peak Road	↔	A	3	3,800	15			30%	24%	1935	1950	402	0.208		475	0.244	0.244
Hung Shui Kiu	←	A	3	3,800						2135	2135	443	0.207		520	0.244	
WB	↔	B	1	4,000	12.5	17.5		74% / 26%	74% / 26%	1815	1815	235	0.129	0.129	210	0.116	0.116
Shun Tat Street	↔	B	1	4,000	12.5	17.5		74% / 26%	74% / 26%	1815	1815	235	0.129	0.129	210	0.116	0.116
NB	↔	B	1	4,000	12.5	17.5		74% / 26%	74% / 26%	1815	1815	235	0.129	0.129	210	0.116	0.116
Pedestrian Crossing		Dp	1	MIN GREEN + FLASH =		7	+	10	=	17							
		Ep	2,3	MIN GREEN + FLASH =		6	+	6	=	12							

<b>Notes:</b>  	<b>Flow: (pcu/hr)</b>	<b>Group</b>	B,C,A	B,F	<b>Group</b>	B,F	B,C,A
		<b>y</b>	0.390	0.423	<b>y</b>	0.414	0.428
		<b>L (sec)</b>	14	9	<b>L (sec)</b>	9	14
		<b>C (sec)</b>	120	120	<b>C (sec)</b>	120	120
		<b>y pract.</b>	0.795	0.833	<b>y pract.</b>	0.833	0.795
		<b>R.C. (%)</b>	104%	97%	<b>R.C. (%)</b>	101%	86%

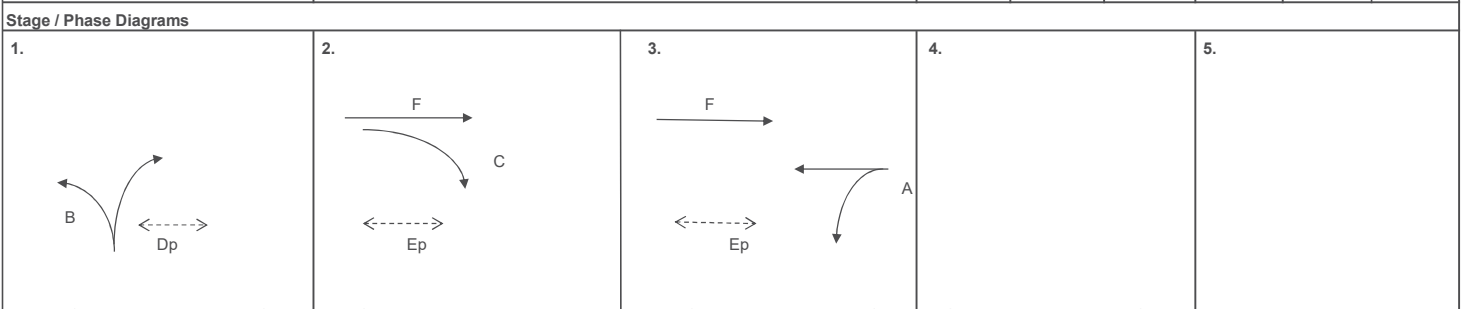

I/G= 6	I/G= 5	I/G=	I/G=	I/G=
I/G= 6	I/G= 5	I/G= 6	I/G=	I/G=
<b>Date:</b> JUN, 2022			<b>Junction:</b> Castle Peak Road - Hung Shui Kiu / Shun Tat Street	

(J5)



# Priority Junction Capacity Calculation



Job Title: CE 92/2017 (CE) Site Formation and Infrastructure Works for Development near Tan Kwai Tsuen, Yuen Long - IDC	Designed by: HWL
Junction: Shun Tat Street - Tat Fuk Road (J6)	Checked by: TKM
Scheme: Reference Weekday AM/ PM Peak	Date: Jun-22
Design Year: 2034	Job No.: CHK50637810
Arm A: Shun Tat Street (WB)	
Arm B: Tat Fuk Road (NB)	
Arm C: Shun Tat Street (EB)	
Arm D: Tat Fuk Road (SB)	

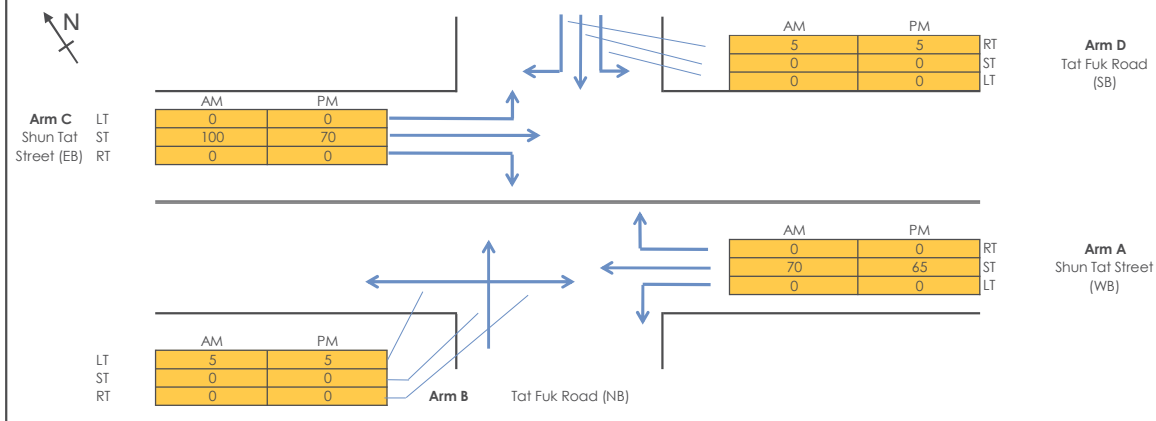

<b>GEOMETRY</b>			
Major Road Width (m)	W	10.00	
Central Reserve Width (m)	Wcr	0.00	

PARAMETER				Arm B				Arm D					
Lane widths (m)	w(b-a)	3.00	Blockage of major road RT (c-b block c-a)?	Y	w(d-c)	3.00	Blockage of major road RT (a-d block a-c)?	Y					
	w(b-c)	3.00				w(d-a)			3.00				
	w(c-b)	4.50				w(a-d)			4.50				
Visibility Distances (m)	Vr(b-a)	30	Calculated Parameters	D	E	120	Calculated Parameters	D	E				
	VI(b-a)	120								0.880	20	0.939	
	Vr(b-c)	50								F	1.060	F	1.022
	Vr(c-b)	100								Y	0.655	Y	0.655
Straight ahead movement using left lane?		Y			Straight ahead movement using left lane?		Y						

ANALYSIS		AM Peak		PM Peak		AM Peak		PM Peak	
TRAFFIC FLOWS (pcu/hr)	q(a-b)	0	0	q(c-d)	0	0			
	q(a-c)	70	65	q(c-a)	100	70			
	q(a-d)	0	0	q(c-b)	0	0			
	q(c-a)	100	70	q(a-c)	70	65			
	q(c-b)	0	0	q(a-d)	0	0			
	q(c-d)	0	0	q(a-b)	0	0			
	q(d-a)	0	0	q(b-c)	5	5			
	q(d-b)	0	0	q(b-d)	0	0			
	q(d-c)	5	5	q(b-a)	0	0			
	q(b-a)	0	0	q(d-c)	5	5			
q(b-d)	0	0	q(d-b)	0	0				
q(b-c)	5	5	q(d-a)	0	0				
Left turn proportion	F	1.00	1.00	Left turn proportion	F	0.00	0.00		
CAPACITIES (pcu/hr)	Q(b-ad)	509	514	Q(d-bc)	513	519			
	Q(b-acd)	641	642	Q(d-abc)	513	519			
	Q(c-b)	772	774	Q(a-d)	737	744			
	Q(c-a)	1800	1800	Q(a-c)	1800	1800			
RFC's	c-b	0.00	0.00	a-d	0.00	0.00			
	c-a	0.06	0.04	a-c	0.04	0.04			
	b-acd	0.01	0.01	d-acd	0.01	0.01			
<b>RFC</b>	<b>0.06</b>	<b>0.04</b>	<b>0.04</b>	<b>0.04</b>	<b>0.04</b>				

Where VI and Vr are visibility distances to the left or right of the respective streams  
 $D = (1 + 0.094(w(b-a) - 3.65)) (1 + 0.0009(Vr(b-a) - 120)) (1 + 0.0006(VI(b-a) - 150))$   
 $E = (1 + 0.094(w(b-c) - 3.65)) (1 + 0.0009(Vr(b-c) - 120))$   
 $F = (1 + 0.094(w(c-b) - 3.65)) (1 + 0.0009(Vr(c-b) - 120))$   
 $Y = 1 - 0.0345W$   
 F = proportion of minor traffic turning left  
 $Q(b-ad) = Q(b-a) * Q(b-d) / (0.5 * Q(b-a) + 0.5 * Q(b-d))$  Capacity of combined streams  
 $Q(b-acd) = Q(b-c) * Q(b-ad) / ((1-F) * Q(b-c) + F * Q(b-ad))$  Capacity of combined streams

All the above formulas are in accordance to T.P.D.M. Vol.2 Chapter 4 Appendix 1

**TRAFFIC SIGNALS CALCULATION**

Job No.: **CHK50637810**

**MVA HONG KONG LIMITED**

Junction: Shun Tat Street / Tung Fuk Road

Design Year: 2034

Description: Reference Weekday AM/ PM Peak (Proposed Future Layout)

Designed By: HWL

Checked By: TKM

Approach	Movements	Phase	Stage	Width (m)	Radius (m)		Gradient (%)	Pro. Turning (%)		Revised Saturation Flow (pcu/hr)		AM Peak			PM Peak		
					Left	Right		AM	PM	AM	PM	Flow (pcu/hr)	y Value	Critical y	Flow (pcu/hr)	y Value	Critical y
Shun Tat Street EB	↔	A	1	3.100	12.5					1720	1720	0	0.000		0	0.000	
	↕	A	1	3.100		7.5		16%	15%	2000	2005	95	0.048	0.048	65	0.032	0.032
Access Road SB	↕	B	2	4.000	10	20		0% / 100%	0% / 100%	1875	1875	5	0.003		5	0.003	
Local Road WB	↔	C	4	3.500		15		0%	0%	1965	1965	5	0.003		5	0.003	
Tung Fuk Road NB	↔	D	5	3.000	7.5	15		100% / 0%	100% / 0%	1595	1595	5	0.003		5	0.003	
	↕	F	3	6.000		8		0%	0%	2215	2215	65	0.029	0.029	65	0.029	0.029
Pedestrian Crossing		Ep	3,4	MIN GREEN + FLASH =			5	+	9	=	14						

<b>Notes:</b>	<b>Flow: (pcu/hr)</b>		<b>Group</b>		A,B,Ep,D	A,B,F,C,D	<b>Group</b>	A,B,Ep,D	A,B,F,C,D
			<b>y</b>	0.048	0.077	<b>y</b>	0.032	0.062	
			<b>L (sec)</b>	51	47	<b>L (sec)</b>	51	47	
			<b>C (sec)</b>	90	90	<b>C (sec)</b>	90	90	
			<b>y pract.</b>	0.390	0.430	<b>y pract.</b>	0.390	0.430	
			<b>R.C. (%)</b>	721%	460%	<b>R.C. (%)</b>	1103%	596%	

<b>Stage / Phase Diagrams</b>				
1.	2.	3.	4.	5.

I/G= 7	I/G= 7	5	I/G= 6	I/G= 5	5	I/G= 9	5
I/G= 7	I/G= 7	5	I/G= 6	I/G= 5	5	I/G= 9	5
<b>Date:</b> JUN, 2022						<b>Junction:</b> Shun Tat Street / Tung Fuk Road	

(J7)

**TRAFFIC SIGNALS CALCULATION**

Job No.: **CHK50637810**

**MVA HONG KONG LIMITED**

Junction: Castle Peak Road - Hung Shui Kiu / Fuk Hang Tsuen Road

Design Year: 2034

Description: Reference Weekday AM/ PM Peak (Proposed CE2 2011 Layout)

Designed By: HWL

Checked By: TKM

Approach	Movements	Phase	Stage	Width (m)	Radius (m)		Gradient (%)	Pro. Turning (%)		Revised Saturation Flow (pcu/hr)		AM Peak			PM Peak		
					Left	Right		AM	PM	AM	PM	Flow (pcu/hr)	y Value	Critical y	Flow (pcu/hr)	y Value	Critical y
Castle Peak Rd	→	E	1	3.250						2080	2080	875	0.421	0.421	910	0.438	0.438
Hung Shui Kiu	→	E	1	3.250						2080	2080	875	0.421		910	0.438	
EB	↕	P	2	3.000		15				1740	1740	240	0.138		240	0.138	
Castle Peak Rd	↔	F	1	3.750	15			18%	16%	1955	1960	445	0.228		476	0.243	
Hung Shui Kiu	←	F	1	3.750						2130	2130	485	0.228		517	0.243	
WB	←	F	1	3.750						2130	2130	485	0.228		517	0.243	
Fuk Hang Tsuen Road (NB)	↕	K	3	3.300	12.5	10		87% / 13%	86% / 14%	1730	1730	355	0.205	0.205	285	0.165	0.165
Pedestrian Crossing		Hp	2	MIN GREEN + FLASH =		10	+	10	=	20				*			*
		Gp	2,3	MIN GREEN + FLASH =		10	+	10	=	20							

Notes:	Flow: (pcu/hr)	Group	E,P,K	E,Hp,K	Group	E,P,K	E,Hp,K
		<b>y</b>	0.764	0.626	<b>y</b>	0.740	0.602
		<b>L (sec)</b>	15	34	<b>L (sec)</b>	15	34
		<b>C (sec)</b>	100	100	<b>C (sec)</b>	100	100
		<b>y pract.</b>	0.765	0.594	<b>y pract.</b>	0.765	0.594
		<b>R.C. (%)</b>	0%	-5%	<b>R.C. (%)</b>	3%	-1%

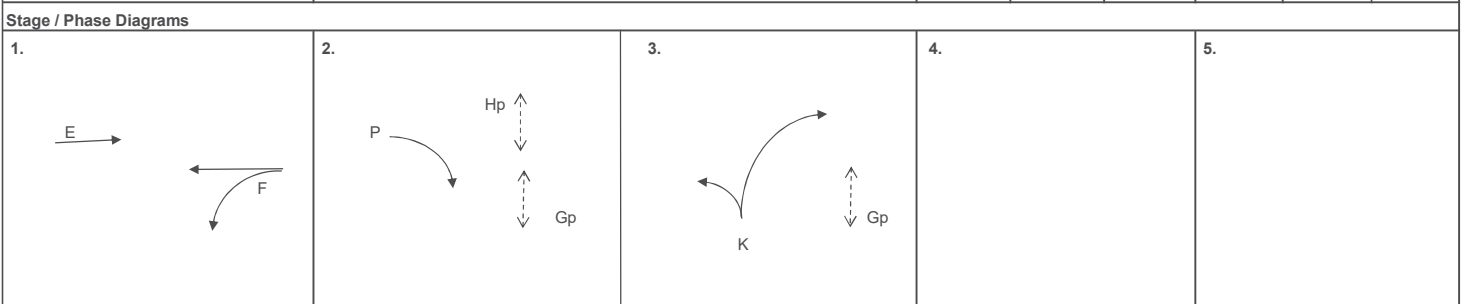

I/G= 7		I/G= 7	20	I/G= 2		I/G=		I/G=	
I/G= 7		I/G= 7	20	I/G= 2		I/G=		I/G=	
<b>Date:</b> JUN, 2022								<b>Junction:</b> Castle Peak Road - Hung Shui Kiu / Fuk Hang Tsuen Road	

(J8)

**TRAFFIC SIGNALS CALCULATION**

Job No.: **CHK50637810**

**MVA HONG KONG LIMITED**

Junction: Castle Peak Road - Hung Shui Kiu / Fuk Hang Tsuen Rd

Design Year: 2034

Description: Reference Weekday AM/ PM Peak (Proposed Further Improvement Scheme)

Designed By: HWL

Checked By: TKM

Approach	Movements	Phase	Stage	Width (m)	Radius (m)		Gradient (%)	Pro. Turning (%)		Revised Saturation Flow (pcu/hr)		AM Peak			PM Peak		
					Left	Right		AM	PM	AM	PM	Flow (pcu/hr)	y Value	Critical y	Flow (pcu/hr)	y Value	Critical y
Castle Peak Rd	→	E	1,4	3.250						2080	2080	875	0.421	0.421	910	0.438	0.438
Hung Shui Kiu	→	E	1,4	3.250						2080	2080	875	0.421	0.421	910	0.438	0.438
EB	↓	P	2	3.000		15				1870	1870	240	0.128	0.128	240	0.128	0.128
Castle Peak Rd	↔	F	1	3.500	15			18%	16%	1930	1935	445	0.231		475	0.245	
Hung Shui Kiu	←	F	1	3.500						2105	2105	485	0.230		518	0.246	
WB	←	F	1	3.500						2105	2105	485	0.230		517	0.246	
Fuk Hang Tsuen Road (NB)	↔	K	3	3.300	15					1770	1770	171	0.097	0.097	137	0.077	
	↔	K	3	3.300	17.5	12.5		76% / 24%	73% / 27%	1905	1905	184	0.097		148	0.078	0.078
Pedestrian Crossing		Hp	2	MIN GREEN + FLASH =		10	+	10	=	20							
		Gp	2,3	MIN GREEN + FLASH =		10	+	10	=	20							
		lp	4	MIN GREEN + FLASH =		5	+	14	=	19							

<b>Notes:</b>	<b>Flow: (pcu/hr)</b>			<b>Group</b>	E, Hp, K	E, P, K	<b>Group</b>	F, P, K, lp	E, P, K
		<b>y</b>	0.517	0.646	<b>y</b>	0.452	0.644		
		<b>L (sec)</b>	30	13	<b>L (sec)</b>	38	13		
		<b>C (sec)</b>	120	120	<b>C (sec)</b>	120	120		
		<b>y pract.</b>	0.675	0.803	<b>y pract.</b>	0.615	0.803		
		<b>R.C. (%)</b>	30%	24%	<b>R.C. (%)</b>	36%	25%		

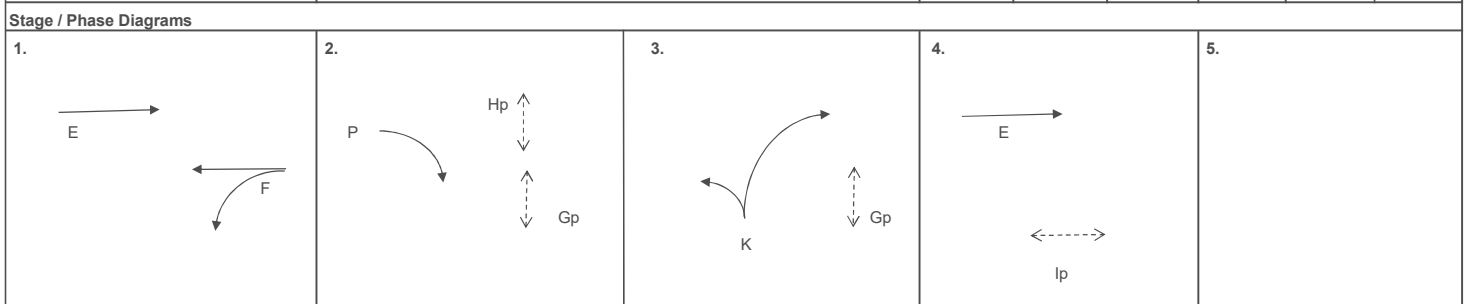

I/G=		I/G= 5		I/G= 6		I/G= 5		I/G=	
I/G=		I/G= 5		I/G= 6		I/G= 5		I/G=	
<b>Date:</b> JUN, 2022							<b>Junction:</b> Castle Peak Road - Hung Shui Kiu / Fuk Hang Tsuen Rd		

(J8)

**TRAFFIC SIGNALS CALCULATION**

Job No.: **CHK50637810**

**MVA HONG KONG LIMITED**

Junction: Castle Peak Road - Hung Tin Road

Design Year: 2034

Description: Reference Weekday AM/ PM Peak

Designed By: HWL

Checked By: TKM

Approach	Movements	Phase	Stage	Width (m)	Radius (m)		Gradient (%)	Pro. Turning (%)		Revised Saturation Flow (pcu/hr)		AM Peak			PM Peak		
					Left	Right		AM	PM	AM	PM	Flow (pcu/hr)	y Value	Critical y	Flow (pcu/hr)	y Value	Critical y
Hung Tin Road SB	L	F	2	3.300	12.5					1735	1735	95	0.055		85	0.049	
	↔	F	2	3.500	15	15	0% / 100%	0% / 100%	1915	1915	250	0.131		212	0.111		
	↕	F	2	3.500		12.5			1880	1880	245	0.130		208	0.111		
Castle Peak Road	↖	C	2,3	3.300	22.5					1825	1825	435	0.238	0.238	420	0.230	0.230
Hung Shui Kiu	→	B	3,4	3.650						1980	1980	263	0.133		273	0.138	
EB	→	B	3,4	3.650						2120	2120	282	0.133		292	0.138	
Castle Peak Road	←	D	1,3,4	3.650						1980	1980	287	0.145		227	0.115	
Hung Shui Kiu	←	D	1,3,4	3.650						2120	2120	308	0.145		243	0.115	
WB	↖	E	1	3.400		15				1905	1905	365	0.192	0.192	315	0.165	0.165
LRT (FIXED TIME)		A	4	MIN GREEN + (FLASH + /			20	+	16	=	36			*			*
Pedestrian Crossing	Gp	1	MIN GREEN + FLASH =			5	+	9	=	14							
	Hp	1,2,3	MIN GREEN + FLASH =			5	+	8	=	13							
	lp	1,3,4	MIN GREEN + FLASH =			5	+	9	=	14							
	jp	4	MIN GREEN + FLASH =			7	+	14	=	21							
	Kp	2	MIN GREEN + FLASH =			8	+	7	=	15							

Notes:	Flow: (pcu/hr)	Group	E,F,Hp,A	E,C,A	Group	E,F,Hp,A	E,C,A
		<b>y</b>	0.322	0.430	<b>y</b>	0.276	0.395
		<b>L (sec)</b>	59	51	<b>L (sec)</b>	57	49
		<b>C (sec)</b>	130	130	<b>C (sec)</b>	130	130
		<b>y pract.</b>	0.492	0.547	<b>y pract.</b>	0.505	0.561
		<b>R.C. (%)</b>	53%	27%	<b>R.C. (%)</b>	83%	42%

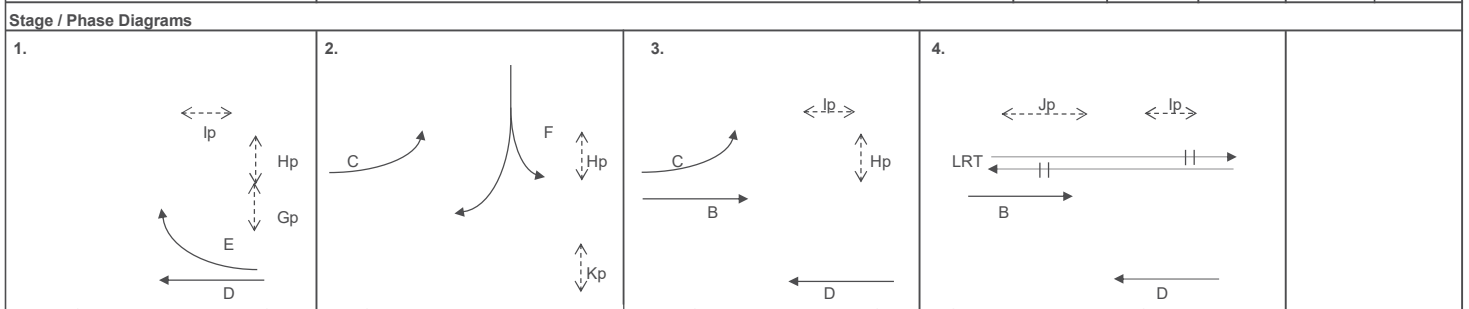

I/G= 2	I/G= 9	I/G=	I/G= 6	36	I/G=
I/G=	I/G= 9	I/G=	I/G= 6	36	I/G=
			<b>Date:</b>	<b>Junction:</b>	
			JUN, 2022	Castle Peak Road - Hung Tin Road	

## Priority Junction Capacity Calculation

Job Title: CE 92/2017 (CE) Site Formation and Infrastructure Works for Development near Tan Kwai Tsuen, Yuen Long - IDC		Designed by: HWL
Junction: Tan Kwai Tsuen Road - Shui Fu Road (J10)		Checked by: TKM
Scheme: Reference Weekday AM/ PM Peak		Date: Jun-22
Design Year: 2034	Job No.: CHK50637810	
Arm A: Tan Kwai Tsuen Road (SB)		
Arm B: Shui Fu Road		
Arm C: Tan Kwai Tsuen Road (NB)		

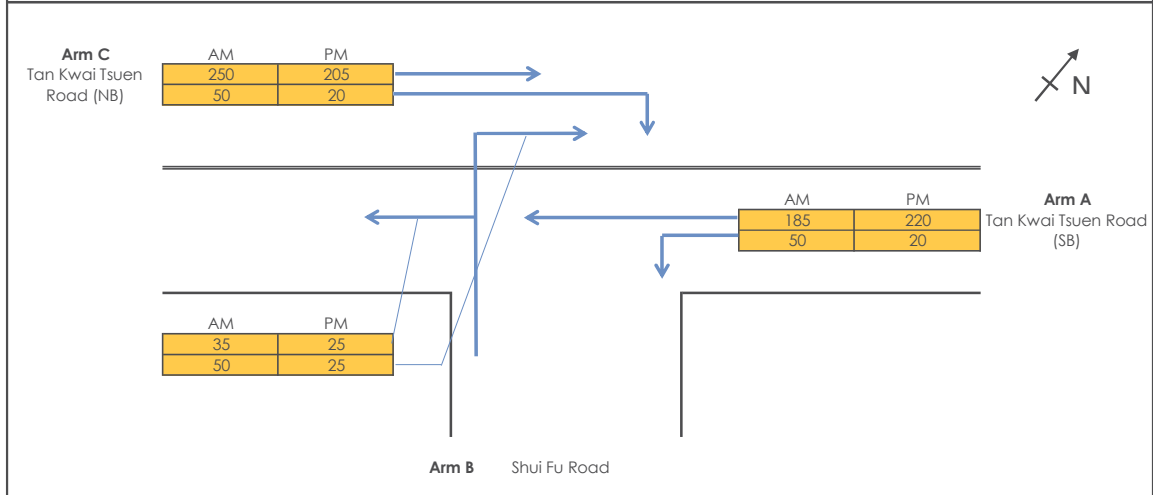

### GEOMETRY

Major Road Width (m)	W	7.25	Lane widths (m)	w(b-a)	3.00
Central Reserve Width (m)	Wcr	0.00		w(b-c)	3.00
Blockage of major road right turn	Y/N?	Y		w(c-b)	3.50
Combined stream on minor arm	Y/N?	Y			
Visibility Distances (m)	Vr(b-a)	80	Calculated Parameters	D	0.867
	Vl(b-a)	80		E	0.905
	Vr(b-c)	80		F	0.933
	Vr(c-b)	60		Y	0.75

### ANALYSIS

		AM	PM
TRAFFIC FLOWS (pcu/hr)	q(c-a)	250	205
	q(c-b)	50	20
	q(a-b)	50	20
	q(a-c)	185	220
	q(b-a)	50	25
	q(b-c)	35	25
	f	0.41	0.50
CAPACITIES (pcu/hr)	Q(b-ac)	502	522
	Q(c-a)	1658	1743
	Q(c-b)	635	634
RFC's	c-a	0.15	0.12
	c-b	0.08	0.03
	b-ac	0.17	0.10
<b>RFC</b>		<b>0.17</b>	<b>0.12</b>

Where Vl and Vr are visibility distances to the left or right of the respective streams  
 $D = (1 + 0.094(w(b-a) - 3.65))(1 + 0.0009(Vr(b-a) - 120))(1 + 0.0006(Vl(b-a) - 150))$   
 $E = (1 + 0.094(w(b-c) - 3.65))(1 + 0.0009(Vr(b-c) - 120))$   
 $F = (1 + 0.094(w(c-b) - 3.65))(1 + 0.0009(Vr(c-b) - 120))$   
 $Y = 1 - 0.0345W$

f = proportion of minor traffic turning left  
 $Q(b-ac) = Q(b-c) * Q(b-a) / (1-f) * Q(b-c) + f * Q(b-a)$  Capacity of combined streams

All the above formulas are in accordance to T.P.D.M. V.2.4 Appendix 1

# Roundabout Capacity Calculation



Job Title:	CE 92/2017 (CE) Site Formation and Infrastructure Works for Development near Tan Kwai Tsuen, Yuen Long - IDC		Designed by:	HWL
Junction:	J11 - Tin Shui Wai West Interchange (New Roundabout)		Checked by:	TKM
Scheme:	Reference Weekday AM Peak		Date:	JUN, 2022
Design Year:	2034	Job No.:	CHK50637810	
Arm A	Yuen Long Highway (Westbound Slip Road)			
Arm B	Road L11			
Arm C	Road L20			
Arm D	Road L22			
Arm E	Hung Tin Road			

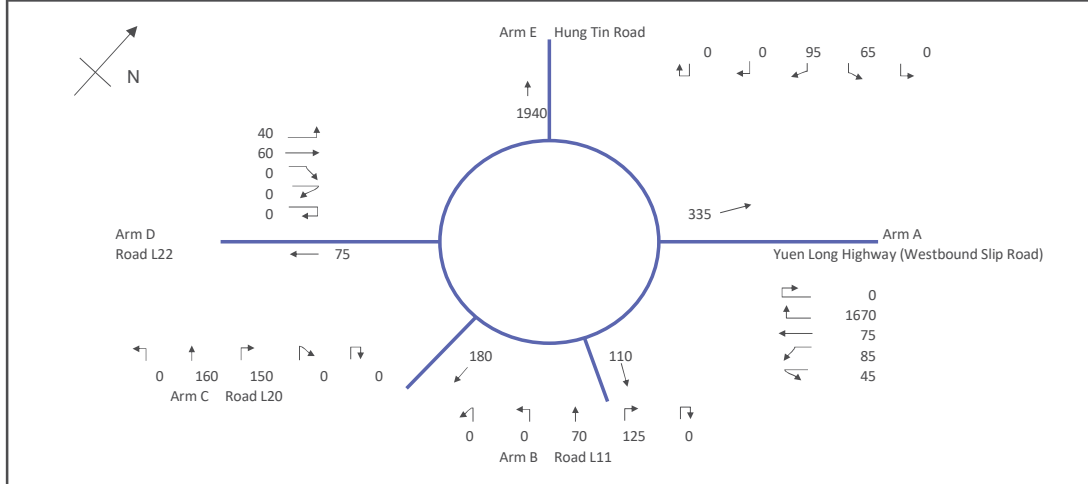

		ENTRY ARM	A	B	C	D	E
<b>INPUT PARAMETERS</b>							
V	Approach Half Width (m)		6.00	5.00	5.40	7.30	5.00
E	Entry Width (m)		8.30	6.20	7.50	10.00	8.50
L	Effective Length of Flare (m)		15.00	20.00	15.00	20.00	20.00
R	Entry Radius (m)		55.00	55.00	50.00	50.00	55.00
D	Inscribed Circle Diameter (m)		90.00	90.00	90.00	90.00	90.00
A	Entry Angle (degree)		20.00	20.00	30.00	30.00	20.00
Q	Entry Flow (pcu/hour)		1,875	195	310	100	160
Qc	Circulating Flow Across Entry (pcu/hour)		160	1,925	1,940	2,175	335
<b>OUTPUT PARAMETERS</b>							
S	= $1.6 (E - V) / L$ Sharpness of flare		0.25	0.10	0.22	0.22	0.28
K	= $1 - 0.00347 (A-30) - 0.978 (1/R - 0.05)$		1.07	1.07	1.03	1.03	1.07
X2	= $V + ((E-V) / (1+2S))$		7.54	6.01	6.85	9.19	7.24
M	= $EXP ((D-60) / 10)$		20.09	20.09	20.09	20.09	20.09
F	= $303 * X2$		2286	1820	2076	2783	2195
Td	= $1 + (0.5 / (1+M))$		1.02	1.02	1.02	1.02	1.02
Fc	= $0.21 * Td (1 + 0.2 * X2)$		0.54	0.47	0.51	0.61	0.53
Qe	= $K (F - Fc * Qc)$		2344	969	1119	1499	2151
DFC	= $Q / Qe$	Design Flow / Capacity	0.80	0.20	0.28	0.07	0.07
		Total Entry Flows	2,640				

All the above formulas are in accordance to T.P.D.M. Vol.2 Chp.4 Sec 4.5.9

# Roundabout Capacity Calculation



Job Title:	CE 92/2017 (CE) Site Formation and Infrastructure Works for Development near Tan Kwai Tsuen, Yuen Long - IDC		Designed by:	HWL
Junction:	J11 - Tin Shui Wai West Interchange (New Roundabout)		Checked by:	TKM
Scheme:	Reference Weekday PM Peak		Date:	JUN, 2022
Design Year:	2034	Job No.:	CHK50637810	
Arm A	Yuen Long Highway (Westbound Slip Road)			
Arm B	Road L11			
Arm C	Road L20			
Arm D	Road L22			
Arm E	Hung Tin Road			

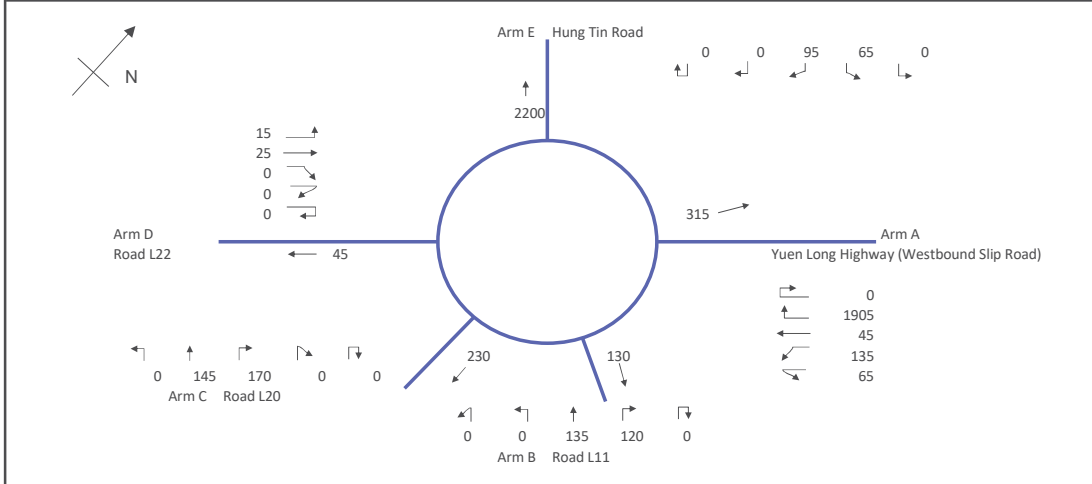

		ENTRY ARM	A	B	C	D	E
<b>INPUT PARAMETERS</b>							
V	Approach Half Width (m)		6.00	5.00	5.40	7.30	5.00
E	Entry Width (m)		8.30	6.20	7.50	10.00	8.50
L	Effective Length of Flare (m)		15.00	20.00	15.00	20.00	20.00
R	Entry Radius (m)		55.00	55.00	50.00	50.00	55.00
D	Inscribed Circle Diameter (m)		90.00	90.00	90.00	90.00	90.00
A	Entry Angle (degree)		20.00	20.00	30.00	30.00	20.00
Q	Entry Flow (pcu/hour)		2,150	255	315	40	160
Qc	Circulating Flow Across Entry (pcu/hour)		160	2,180	2,205	2,475	315
<b>OUTPUT PARAMETERS</b>							
S	$= 1.6 (E - V) / L$ Sharpness of flare		0.25	0.10	0.22	0.22	0.28
K	$= 1 - 0.00347 (A-30) - 0.978 (1/R - 0.05)$		1.07	1.07	1.03	1.03	1.07
X2	$= V + ((E-V) / (1+2S))$		7.54	6.01	6.85	9.19	7.24
M	$= EXP ((D-60) / 10)$		20.09	20.09	20.09	20.09	20.09
F	$= 303 * X2$		2286	1820	2076	2783	2195
Td	$= 1 + (0.5 / (1+M))$		1.02	1.02	1.02	1.02	1.02
Fc	$= 0.21 * Td (1 + 0.2 * X2)$		0.54	0.47	0.51	0.61	0.53
Qe	$= K (F - Fc * Qc)$		2344	840	980	1311	2163
DFC	$= Q / Qe$	Design Flow / Capacity	0.92	0.30	0.32	0.03	0.07
		Total Entry Flows	2,920				

All the above formulas are in accordance to T.P.D.M. Vol.2 Chp.4 Sec 4.5.9



**TRAFFIC SIGNALS CALCULATION**

Job No.: **CHK50637810**

**MVA HONG KONG LIMITED**

Junction: Shui Fu Road / Proposed Access Road

Design Year: 2034

Description: Reference Weekday AM/ PM Peak

Designed By: HWL

Checked By: TKM

Approach	Movements	Phase	Stage	Width (m)	Radius (m)		Gradient (%)	Pro. Turning (%)		Revised Saturation Flow (pcu/hr)		AM Peak			PM Peak		
					Left	Right		AM	PM	AM	PM	Flow (pcu/hr)	y Value	Critical y	Flow (pcu/hr)	y Value	Critical y
Access Road (WB)	↓	B	2	4,500	7.5			100%	100%	1720	1720	75	0.044	0.044	45	0.026	0.026
Access Road (EB)	↑	A	1	5,000		18		100%	100%	1950	1950	5	0.003		5	0.003	
Shui Fu Road (Lower section)	↔	C	3	5,000	22.5	15		5% / 95%	11% / 89%	1925	1930	105	0.055	0.055	45	0.023	0.023
Shui Fu Road (Upper section)	↔	D	4	5,000	22.5	12.5		0% / 100%	0% / 100%	1890	1890	10	0.005		5	0.003	
Pedestrian Crossing		Ep	5	MIN GREEN + FLASH =		7	+	9	=	16							*
		Fp	5	MIN GREEN + FLASH =		7	+	9	=	16							*

Notes:	Flow: (pcu/hr)	Group	A,B,C,D,Ep	A,B,C,D,Ep	Group	A,B,C,D,Ep	A,B,C,D,Ep
		<b>y</b>	0.098	0.098	<b>y</b>	0.049	0.049
		<b>L (sec)</b>	59	59	<b>L (sec)</b>	59	59
		<b>C (sec)</b>	100	100	<b>C (sec)</b>	100	100
		<b>y pract.</b>	0.369	0.369	<b>y pract.</b>	0.369	0.369
		<b>R.C. (%)</b>	276%	276%	<b>R.C. (%)</b>	646%	646%

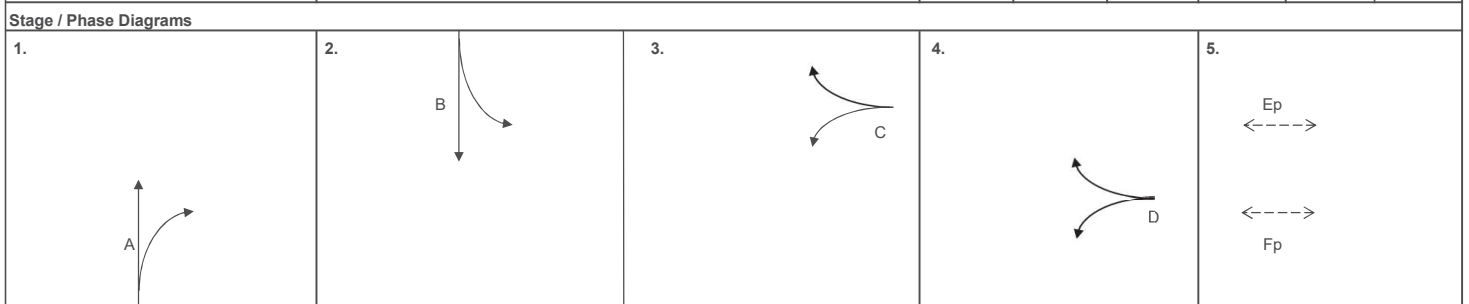

I/G= 7	5	I/G= 7		I/G= 7		I/G= 7	5	I/G= 7	16
I/G= 7	5	I/G= 7		I/G= 7		I/G= 7	5	I/G= 7	16
<b>Date:</b> JUN, 2022								<b>Junction:</b> Shui Fu Road / Proposed Access Road	

(12)

# 2034 Design Junction Calculations

## TRAFFIC SIGNALS CALCULATION

Job No.: **CHK50637810**

MVA HONG KONG LIMITED

Junction: Hung Tin Road / Hung Chi Road

Design Year: 2034

Description: Design Weekday AM/ PM Peak

Designed By: HWL

Checked By: TKM

Approach	Movements	Phase	Stage	Width (m)	Radius (m)		Gradient (%)	Pro. Turning (%)		Revised Saturation Flow (pcu/hr)		AM Peak			PM Peak		
					Left	Right		AM	PM	AM	PM	Flow (pcu/hr)	y Value	Critical y	Flow (pcu/hr)	y Value	Critical y
Hung Tin Road NB	↕	G	4	3.400	12.5			97%	100%	1750	1745	718	0.410	0.410	725	0.415	0.415
	↕	G	4	3.400		12.5		65%	70%	1945	1930	796	0.409		772	0.400	
	↕	G	4	3.400		10				1820	1820	746	0.410		728	0.400	
Hung Chi Road EB	→	H	1	3.500	12.5			57%	64%	1840	1825	70	0.038		47	0.026	
	→	H	1	3.500						2105	2105	80	0.038		54	0.026	
	→	H	1	3.500						2105	2105	80	0.038		54	0.026	
Shek Po East Rd SB	↙	I	3	4.500	12.5					1845	1845	75	0.041	0.041	50	0.027	
HSK Interchange EB	→	A	1,4	3.400						1955	1955	185	0.095		160	0.082	
	↘	B	4	3.400		20				1950	1950	678	0.348		665	0.341	
	↘	B	4	3.400		15				1905	1905	662	0.348		650	0.341	
HSK Interchange WB	↖	F	2	3.500		15				1915	1915	30	0.016		40	0.021	
	↖	E	1,2	3.300						1945	1945	85	0.044		60	0.031	
Hung Tin Road SB	↕	C	4	3.400	10			13%	11%	1915	1925	189	0.099	0.099	136	0.071	
	↕	C	4	3.400						2095	2095	206	0.098		149	0.071	0.071
	↕	C	4	3.400		17.5				1930	1930	75	0.039		45	0.023	
Hung Chi Road WB	↖	D	1	3.500						2105	2105	40	0.019		55	0.026	
	↖	D	1	3.500	10					1710	1710	80	0.047	0.047	120	0.070	0.070
Pedestrian Crossing	Jp	3,4	MIN GREEN + FLASH =		7	+	10	=	17								
	Kp	3	MIN GREEN + FLASH =		6	+	6	=	12								
	Lp	2,3,4	MIN GREEN + FLASH =		6	+	6	=	12								
	Mp	3	MIN GREEN + FLASH =		7	+	9	=	16								
	Np	1,2,3	MIN GREEN + FLASH =		7	+	10	=	17								
	Op	3	MIN GREEN + FLASH =		6	+	6	=	12								
	Pp	2,3,4	MIN GREEN + FLASH =		7	+	9	=	16								

Notes:	Traffic Flow (pcu/hr)	Group	H.C.I,G	D.C.I,G	Group	H.C.I,G	D.C.I,G
		<b>y</b>	0.588	0.596	<b>y</b>	0.487	0.557
		<b>L (sec)</b>	22	21	<b>L (sec)</b>	34	27
		<b>C (sec)</b>	120	120	<b>C (sec)</b>	120	120
		<b>y pract.</b>	0.735	0.743	<b>y pract.</b>	0.645	0.698
		<b>R.C. (%)</b>	25%	24%	<b>R.C. (%)</b>	33%	25%

Stage / Phase Diagrams							
1.	2.	3.	4.	5.			
I/G= 6		I/G= 6		I/G= 6		I/G= 7	
I/G= 6		I/G= 6		I/G= 6	5	I/G= 7	
Date: JUN, 2022						Junction: Hung Tin Road / Hung Chi Road	

**TRAFFIC SIGNALS CALCULATION**

Job No.: CHK50637810

MVA HONG KONG LIMITED

Junction: Castle Peak Road - Hung Shui Kiu / Hung Tak Road

Design Year: 2034

Description: Design Weekday AM/ PM Peak (TD Improvement Scheme)

Designed By: HWL

Checked By: TKM

Approach	Movements	Phase	Stage	Width (m)	Radius (m)		Gradient (%)	Pro. Turning (%)		Revised Saturation Flow (pcu/hr)		AM Peak			PM Peak		
					Left	Right		AM	PM	AM	PM	Flow (pcu/hr)	y Value	Critical y	Flow (pcu/hr)	y Value	Critical y
Castle Peak Road - Hung Shui Kiu WB	↙ ← ↑	C D D	2 1 1	3.300 3.300 3.300	15					1770 2085 2085	1770 2085 2085	430 385 385	0.243 0.185 0.185	0.243 0.185	330 323 322	0.186 0.155 0.154	0.186
Hung Tak Road NB	**↕↗	B	2	3.500	10	15	14% / 86%	12% / 88%		1920	1920	385	0.201		210	0.109	
Castle Peak Road - Hung Shui Kiu EB	* →	A A A	1 1 1	3.300 3.300 3.300						1750 2085 2085	1750 2085 2085	241 287 287	0.138 0.138 0.138		266 317 317	0.152 0.152 0.152	0.152
Pedestrian Crossing		Ep Fp Gp	1,3 1,3 3	MIN GREEN + FLASH = MIN GREEN + FLASH = MIN GREEN + FLASH =	5 5 10	+	7 6 8	= = =	12 11 18					*			*

<b>Notes:</b> * Site factor = 0.9 is used (Effect of bus stop situated at Castle Peak Road - Hung Shui Kiu EB)  ** Saturation flow at Hung Tak Road increased	<b>Flow: (pcu/hr)</b> 	<b>Group</b>	D.B.Gp	D.C.Gp	<b>Group</b>	D.C.Gp	A.C.Gp
		<b>y</b>	0.385	0.428	<b>y</b>	0.341	0.338
		<b>L (sec)</b>	30	27	<b>L (sec)</b>	27	28
		<b>C (sec)</b>	90	90	<b>C (sec)</b>	90	90
		<b>y pract.</b>	0.600	0.630	<b>y pract.</b>	0.630	0.620
		<b>R.C. (%)</b>	56%	47%	<b>R.C. (%)</b>	85%	83%

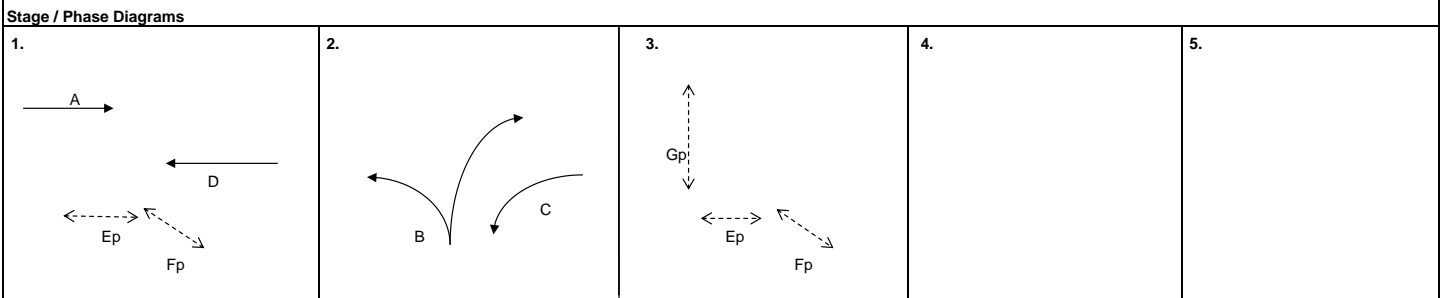

I/G= 2	I/G= 5	I/G= 4	18	I/G=	I/G=
I/G= 3	I/G= 5	I/G= 4	18	I/G=	I/G=

Date: SEP, 2022 Junction: Castle Peak Road - Hung Shui Kiu / Hung Tak Road (J2)

**TRAFFIC SIGNALS CALCULATION**

Job No.: **CHK50637810**

**MVA HONG KONG LIMITED**

Junction: Castle Peak Road - Hung Shui Kiu/ Tan Kwai Tsuen Road

Design Year: 2034

Description: Design Weekday AM/ PM Peak (TD Improvement Scheme)

Designed By: HWL

Checked By: TKM

Approach	Movements	Phase	Stage	Width (m)	Radius (m)		Gradient (%)	Pro. Turning (%)		Revised Saturation Flow (pcu/hr)		AM Peak			PM Peak		
					Left	Right		AM	PM	AM	PM	Flow (pcu/hr)	y Value	Critical y	Flow (pcu/hr)	y Value	Critical y
Castle Peak Rd Hung Shui Kiu WB	→ → ↘	I I H	1,2 1,2 2	3.300 3.300 3.300						1945 2085 1985	1945 2085 1985	335 360 225	0.172 0.173 0.113	0.113	389 416 225	0.200 0.200 0.113	0.113
Castle Peak Rd Hung Shui Kiu EB	← ←	G G	1 1	3.650 3.650						1980 2120	1980 2120	398 427	0.201 0.201	0.201	326 349	0.165 0.165	0.165
Tan Kwai Tsuen Road NB	↕	F	3	4.000	15	17.5		71% / 29% 69% / 31%		1840 1840	1840 1840	410	0.223	0.223	310	0.168	0.168
Pedestrian Crossing		Jp	1	MIN GREEN + FLASH =		10	+	7	=	17							

Notes:	Flow: (pcu/hr)			<b>Group</b>	Jp,H,F	G,H,F	<b>Group</b>	I,F	G,H,F
	<b>y</b>	0.336	0.538	<b>y</b>	0.368	0.446			
	<b>L (sec)</b>	29	19	<b>L (sec)</b>	13	19			
	<b>C (sec)</b>	90	90	<b>C (sec)</b>	90	90			
	<b>y pract.</b>	0.610	0.710	<b>y pract.</b>	0.770	0.710			
	<b>R.C. (%)</b>	81%	32%	<b>R.C. (%)</b>	109%	59%			

<b>Stage / Phase Diagrams</b>				
1.	2.	3.	4.	5.

I/G= 6	I/G= 7	I/G= 9	I/G=	I/G=
I/G= 6	I/G= 7	I/G= 9	I/G=	I/G=
Date: SEP, 2022			Junction:  Castle Peak Road / Tan Kwai Tsuen Road (MN37)	

# Priority Junction Capacity Calculation

Job Title: CE 92/2017 (CE) Site Formation and Infrastructure Works for Development near Tan Kwai Tsuen, Yuen Long - IDC	Designed by: HWL
Junction: Tan Kwai Tsuen Road - Hung Shun Road (J4)	Checked by: TKM
Scheme: Design Weekday AM/ PM Peak	Date: Sep-22
Design Year 2034	Job No.: CHK50637810

Arm A: Tan Kwai Tsuen Road (SB)
Arm B: Hung Shun Road
Arm C: Tan Kwai Tsuen Road (NB)

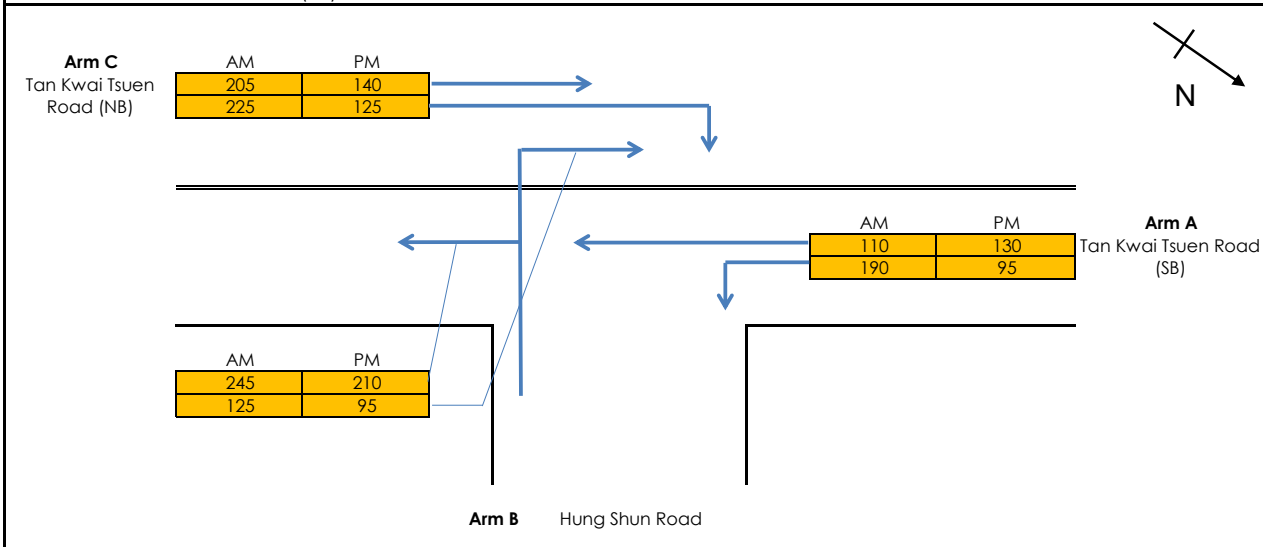

GEOMETRY					
Major Road Width (m)	W	8.00	Lane widths (m)	w(b-a)	3.50
Central Reserve Width (m)	Wcr	0.00		w(b-c)	3.50
Blockage of major road right turn	Y/N?	Y		w(c-b)	3.50
Combined stream on minor arm	Y/N?	Y			

Visibility Distances (m)	Vr(b-a)	60	Calculated Parameters	D	0.863
	VI(b-a)	25		E	0.942
	Vr(b-c)	70		F	0.968
	Vr(c-b)	100		Y	0.724

ANALYSIS		AM	PM
TRAFFIC FLOWS (pcu/hr)	q(c-a)	205	140
	q(c-b)	225	125
	q(a-b)	190	95
	q(a-c)	110	130
	q(b-a)	125	95
	q(b-c)	245	210
	f	0.66	0.69
CAPACITIES (pcu/hr)	Q(b-ac)	537	572
	Q(c-a)	1171.83	1461
	Q(c-b)	645	664
RFC's	c-a	0.17	0.10
	c-b	0.35	0.19
	b-ac	0.69	0.53
<b>RFC</b>		<b>0.69</b>	<b>0.53</b>

Where VI and Vr are visibility distances to the left or right of the respective streams  
 $D = (1+0.094(w(b-a)-3.65))(1+0.0009(Vr(b-a)-120))(1+0.0006(VI(b-a)-150))$   
 $E = (1+0.094(w(b-c)-3.65))(1+0.0009(Vr(b-c)-120))$   
 $F = (1+0.094(w(c-b)-3.65))(1+0.0009(Vr(c-b)-120))$   
 $Y = 1-0.0345W$   
 f = proportion of minor traffic turning left  
 $Q(b-ac) = Q(b-c)*Q(b-a)/(1-f)*Q(b-c)+f*Q(b-a)$  Capacity of combined streams

All the above formulas are in accordance to T.P.D.M. V.2.4 Appendix 1

**TRAFFIC SIGNALS CALCULATION**

Job No.: **CHK50637810**

**MVA HONG KONG LIMITED**

Junction: Castle Peak Road - Hung Shui Kiu / Shun Tat Street

Design Year: 2034

Description: Design Weekday AM/ PM Peak (TD Improvement Scheme)

Designed By: HWL

Checked By: TKM

Approach	Movements	Phase	Stage	Width (m)	Radius (m)		Gradient (%)	Pro. Turning (%)		Revised Saturation Flow (pcu/hr)		AM Peak			PM Peak		
					Left	Right		AM	PM	AM	PM	Flow (pcu/hr)	y Value	Critical y	Flow (pcu/hr)	y Value	Critical y
Castle Peak Rd	→	F	1	3.500						2105	2105	751	0.357	0.357	767	0.364	0.364
Hung Shui Kiu EB	↕	C	1	3.500		20		41%	42%	2040	2040	729	0.357		743	0.364	
Castle Peak Road	↕	A	3	3.800	15			38%	32%	1920	1935	448	0.233	0.233	492	0.254	
Hung Shui Kiu WB	←	A	3	3.800						2135	2135	497	0.233		543	0.254	0.254
Shun Tat Street NB	↕	B	2	4.000	12.5	17.5		72% / 28%	72% / 28%	1815	1815	530	0.292	0.292	440	0.242	0.242
Pedestrian Crossing		Dp	2	MIN GREEN + FLASH =		7	+	10	=	17							
		Ep	1,3	MIN GREEN + FLASH =		6	+	6	=	12							

<b>Notes:</b>	<b>Flow: (pcu/hr)</b>	<b>Group</b>	C,Dp,A	F,B,A	<b>Group</b>	C,Dp,A	F,B,A
		<b>y</b>	0.591	0.882	<b>y</b>	0.619	0.861
		<b>L (sec)</b>	30	14	<b>L (sec)</b>	30	14
		<b>C (sec)</b>	120	120	<b>C (sec)</b>	120	120
		<b>y pract.</b>	0.675	0.795	<b>y pract.</b>	0.675	0.795
		<b>R.C. (%)</b>	14%	-10%	<b>R.C. (%)</b>	9%	-8%

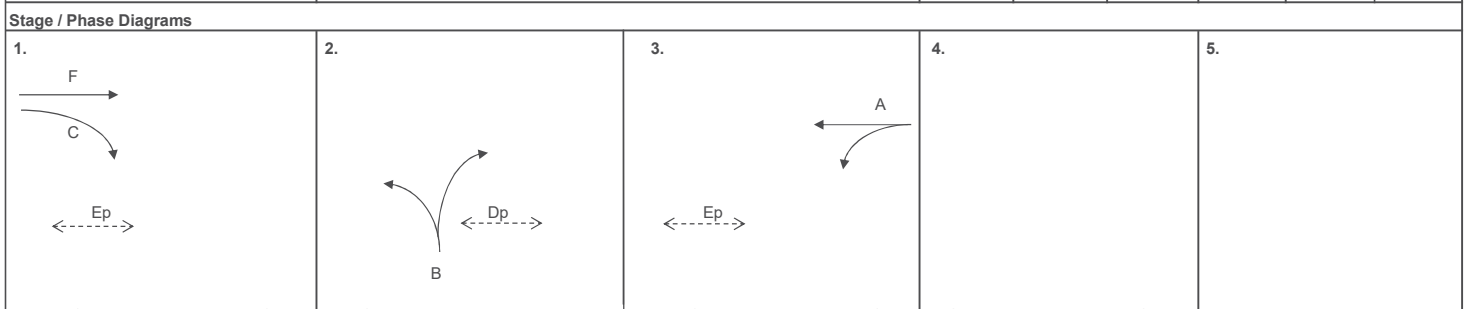

I/G= 5	I/G= 6	I/G= 6	I/G= 6	I/G= 6	I/G= 6	I/G= 6	I/G= 6
I/G= 5	I/G= 6	I/G= 6	I/G= 6	I/G= 6	I/G= 6	I/G= 6	I/G= 6
<b>Date:</b> JUN, 2022						<b>Junction:</b> Castle Peak Road - Hung Shui Kiu / Shun Tat Street	

(J5)

**TRAFFIC SIGNALS CALCULATION**

Job No.: **CHK50637810**

**MVA HONG KONG LIMITED**

Junction: Castle Peak Road - Hung Shui Kiu / Shun Tat Street

Design Year: 2034

Description: Design Weekday AM/ PM Peak (Proposed Further Improvement Scheme)

Designed By: HWL

Checked By: TKM

Approach	Movements	Phase	Stage	Width (m)	Radius (m)		Gradient (%)	Pro. Turning (%)		Revised Saturation Flow (pcu/hr)		AM Peak			PM Peak		
					Left	Right		AM	PM	AM	PM	Flow (pcu/hr)	y Value	Critical y	Flow (pcu/hr)	y Value	Critical y
Castle Peak Rd	→	F	2,3	3,300						1945	1945	570	0.293		579	0.298	
Hung Shui Kiu	→	F	2,3	3,300						2085	2085	610	0.293		621	0.298	
EB	↓	C	2	3,300		15				1895	1895	300	0.158	0.158	310	0.164	0.164
Castle Peak Road	↔	A	3	3,800	15			38%	32%	1920	1935	448	0.233	0.233	492	0.254	
Hung Shui Kiu	←	A	3	3,800						2135	2135	497	0.233		543	0.254	0.254
WB																	
Shun Tat Street	↕	B	1	4,000	12.5	17.5		72% / 28%	72% / 28%	1815	1815	530	0.292	0.292	440	0.242	0.242
NB																	
Pedestrian Crossing		Dp	1	MIN GREEN + FLASH =		7	+	10	=	17							
		Ep	2,3	MIN GREEN + FLASH =		6	+	6	=	12							

Notes:	Flow: (pcu/hr)	Group	B,F		B,C,A		Group	B,F		B,C,A		
			y	L (sec)	C (sec)	y pract.		R.C. (%)	y	L (sec)	C (sec)	y pract.
			0.585	9	120	0.833	42%	0.684	14	120	0.795	16%
			0.540	9	120	0.833	54%	0.660	14	120	0.795	20%

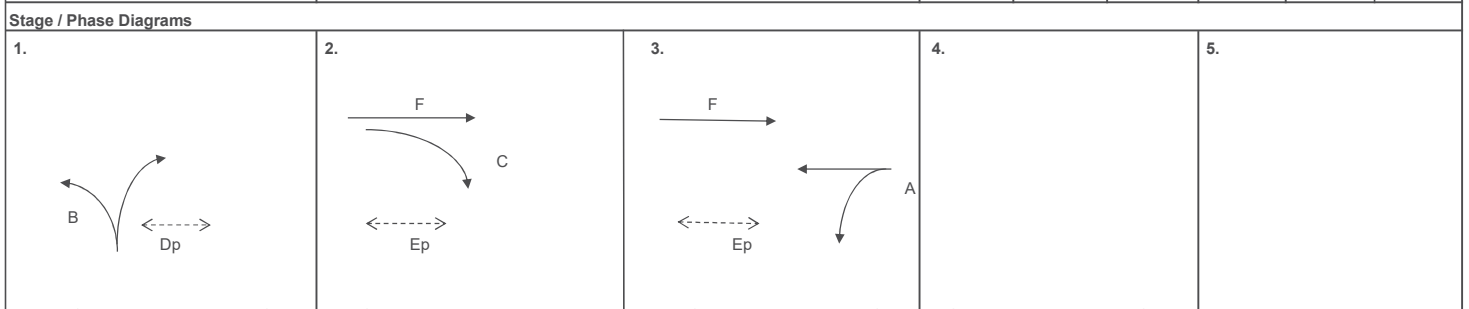

I/G= 6		I/G= 5		I/G= 6		I/G=		I/G=	
I/G= 6		I/G= 5		I/G= 6		I/G=		I/G=	
Date: JUN, 2022								Junction: Castle Peak Road - Hung Shui Kiu / Shun Tat Street	

(J5)

# Priority Junction Capacity Calculation



Job Title: CE 92/2017 (CE) Site Formation and Infrastructure Works for Development near Tan Kwai Tsuen, Yuen Long - IDC	Designed by: HWL
Junction: Shun Tat Street - Tat Fuk Road (J6)	Checked by: TKM
Scheme: Design Weekday AM/ PM Peak	Date: Jun-22
Design Year: 2034	Job No.: CHK50637810
Arm A: Shun Tat Street (WB)	
Arm B: Tat Fuk Road (NB)	
Arm C: Shun Tat Street (EB)	
Arm D: Tat Fuk Road (SB)	

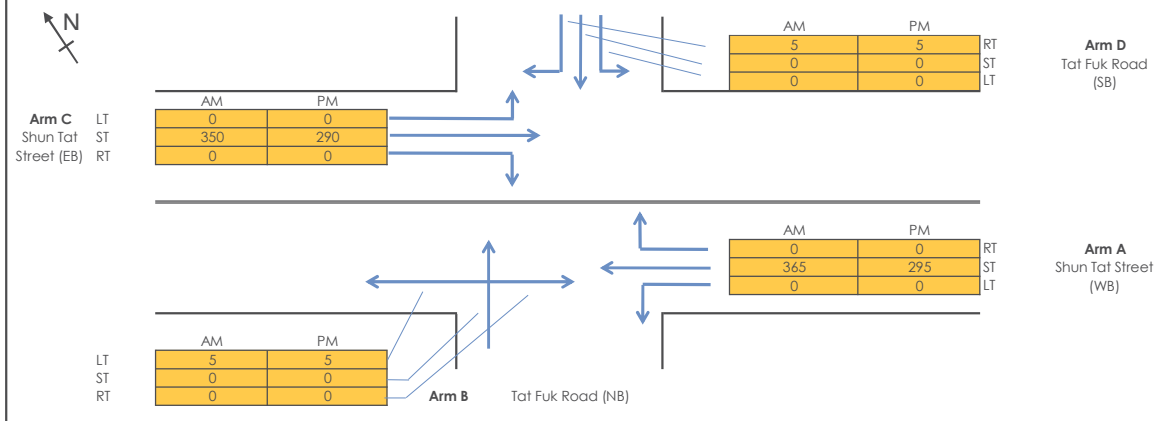

## GEOMETRY

Major Road Width (m)	W	10.00
Central Reserve Width (m)	Wcr	0.00

PARAMETER				Arm B				Arm D			
Lane widths (m)	w(b-a)	3.00	Blockage of major road RT (c-b block c-a)?	Y	w(d-c)	3.00	Blockage of major road RT (a-d block a-c)?	Y			
	w(b-c)	3.00				w(d-a)			3.00		
	w(c-b)	4.50				w(a-d)			4.50		
Visibility Distances (m)	Vr(b-a)	30	Calculated Parameters	D	0.847	E	0.866				
	VI(b-a)	120						F	1.022		
	Vr(b-c)	50								Y	0.655
	Vr(c-b)	100									
Straight ahead movement using left lane?		Y	Straight ahead movement using left lane?		Y						

## ANALYSIS

		AM Peak		PM Peak				AM Peak		PM Peak	
TRAFFIC FLOWS (pcu/hr)	q(a-b)	0	0	q(c-d)	0	0	TRAFFIC FLOWS (pcu/hr)	q(c-d)	0	0	
	q(a-c)	365	295	q(c-a)	350	290		q(c-b)	0	0	
	q(a-d)	0	0	q(a-c)	365	295		q(a-d)	0	0	
	q(c-a)	350	290	q(a-b)	0	0		q(b-c)	5	5	
	q(c-b)	0	0	q(d-a)	0	0		q(b-d)	0	0	
	q(c-d)	0	0	q(d-b)	0	0		q(b-a)	0	0	
	q(d-a)	0	0	q(d-c)	5	5		q(d-c)	5	5	
	q(d-b)	0	0	q(b-a)	0	0		q(d-b)	0	0	
	q(d-c)	5	5	q(b-a)	0	0		q(d-a)	0	0	
	q(b-a)	0	0	q(b-c)	5	5		Left turn proportion	F	0.00	0.00

		AM Peak		PM Peak				AM Peak		PM Peak	
CAPACITIES (pcu/hr)	Q(b-ad)	417	439	Q(d-bc)	423	444	CAPACITIES (pcu/hr)	Q(d-bc)	423	444	
	Q(b-acd)	579	594	Q(d-abc)	423	444		Q(a-d)	676	690	
	Q(c-b)	698	715	Q(a-d)	676	690		Q(a-c)	1800	1800	
	Q(c-a)	1800	1800	RFC's	a-d	0.00		0.00			

RFC's	c-b	0.00	0.00	a-c	0.20	0.16
	c-a	0.19	0.16	d-acd	0.01	0.01
	b-acd	0.01	0.01	<b>RFC</b>	<b>0.19</b>	<b>0.16</b>

Where VI and Vr are visibility distances to the left or right of the respective streams  
 $D = (1 + 0.094(w(b-a) - 3.65)) (1 + 0.0009(Vr(b-a) - 120)) (1 + 0.0006(VI(b-a) - 150))$   
 $E = (1 + 0.094(w(b-c) - 3.65)) (1 + 0.0009(Vr(b-c) - 120))$   
 $F = (1 + 0.094(w(c-b) - 3.65)) (1 + 0.0009(Vr(c-b) - 120))$   
 $Y = 1 - 0.0345W$   
 $F = \text{proportion of minor traffic turning left}$   
 $Q(b-ad) = Q(b-a) * Q(b-d) / (0.5 * Q(b-a) + 0.5 * Q(b-d))$  Capacity of combined streams  
 $Q(b-acd) = Q(b-c) * Q(b-ad) / ((1-F) * Q(b-c) + F * Q(b-ad))$  Capacity of combined streams

**All the above formulas are in accordance to T.P.D.M. Vol.2 Chapter 4 Appendix 1**



**TRAFFIC SIGNALS CALCULATION**

Job No.: **CHK50637810**

**MVA HONG KONG LIMITED**

Junction: Shun Tat Street / Tung Fuk Road

Design Year: 2034

Description: Design Weekday AM/ PM Peak (Proposed Future Layout)

Designed By: HWL

Checked By: TKM

Approach	Movements	Phase	Stage	Width (m)	Radius (m)		Gradient (%)	Pro. Turning (%)		Revised Saturation Flow (pcu/hr)		AM Peak			PM Peak		
					Left	Right		AM	PM	AM	PM	Flow (pcu/hr)	y Value	Critical y	Flow (pcu/hr)	y Value	Critical y
Shun Tat Street EB	↔	A	1	3.100	12.5					1720	1720	250	0.145	0.145	220	0.128	0.128
	↕	A	1	3.100		7.5		16%	15%	2000	2005	95	0.048		65	0.032	
Access Road SB	↕↔	B	2	4.000	10	20		0% / 100%	0% / 100%	1875	1875	300	0.160	0.160	235	0.125	0.125
Local Road WB	↕↔	C	4	3.500		15		0%	0%	1965	1965	5	0.003		5	0.003	
Tung Fuk Road NB	↔↕	D	5	3.000	7.5	15		100% / 0%	100% / 0%	1595	1595	5	0.003		5	0.003	
	↕	F	3	6.000		8		0%	0%	2215	2215	65	0.029		65	0.029	
Pedestrian Crossing		Ep	3,4	MIN GREEN + FLASH =			5	+	9	=	14						

<b>Notes:</b>	<b>Flow: (pcu/hr)</b>		<b>Group</b>		A,B,Ep,D	A,B,F,C,D	<b>Group</b>	A,B,Ep,D	A,B,F,C,D
			<b>y</b>	0.305	0.305	<b>y</b>	0.253	0.253	
	<b>L (sec)</b>	45	47	<b>L (sec)</b>	45	47			
	<b>C (sec)</b>	90	90	<b>C (sec)</b>	90	90			
	<b>y pract.</b>	0.450	0.430	<b>y pract.</b>	0.450	0.430			
	<b>R.C. (%)</b>	47%	41%	<b>R.C. (%)</b>	78%	70%			

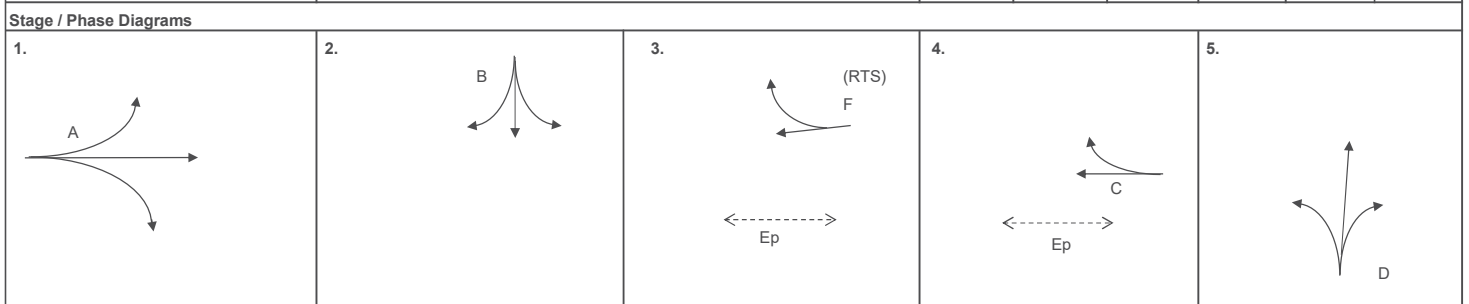

I/G= 7	I/G= 7	I/G= 6	5	I/G= 5	5	I/G= 9	5
I/G= 7	I/G= 7	I/G= 6	5	I/G= 5	5	I/G= 9	5
<b>Date:</b> JUN, 2022						<b>Junction:</b> Shun Tat Street / Tung Fuk Road	

(J7)

**TRAFFIC SIGNALS CALCULATION**

Job No.: **CHK50637810**

**MVA HONG KONG LIMITED**

Junction: Castle Peak Road - Hung Shui Kiu / Fuk Hang Tsuen Road

Design Year: 2034

Description: Design Weekday AM/ PM Peak (Proposed CE2 2011 Layout)

Designed By: HWL

Checked By: TKM

Approach	Movements	Phase	Stage	Width (m)	Radius (m)		Gradient (%)	Pro. Turning (%)		Revised Saturation Flow (pcu/hr)		AM Peak			PM Peak		
					Left	Right		AM	PM	AM	PM	Flow (pcu/hr)	y Value	Critical y	Flow (pcu/hr)	y Value	Critical y
Castle Peak Rd	→	E	1	3.250						2080	2080	975	0.469	0.469	1000	0.481	0.481
Hung Shui Kiu	→	E	1	3.250						2080	2080	975	0.469		1000	0.481	
EB	↕	P	2	3.000		15				1740	1740	240	0.138		240	0.138	
Castle Peak Rd	↔	F	1	3.750	15			15%	14%	1960	1960	526	0.268		527	0.269	
Hung Shui Kiu	←	F	1	3.750						2130	2130	572	0.269		572	0.269	
WB	←	F	1	3.750						2130	2130	572	0.269		571	0.268	
Fuk Hang Tsuen Road (NB)	↕	K	3	3.300	12.5	10		87% / 13%	86% / 14%	1730	1730	355	0.205	0.205	285	0.165	0.165
Pedestrian Crossing		Hp	2	MIN GREEN + FLASH =		10	+	10	=	20				*			*
		Gp	2,3	MIN GREEN + FLASH =		10	+	10	=	20							

Notes:	Flow: (pcu/hr)	Group	E,P,K	E,Hp,K	Group	E,P,K	E,Hp,K
		<b>y</b>	0.812	0.674	<b>y</b>	0.783	0.646
		<b>L (sec)</b>	15	34	<b>L (sec)</b>	15	34
		<b>C (sec)</b>	100	100	<b>C (sec)</b>	100	100
		<b>y pract.</b>	0.765	0.594	<b>y pract.</b>	0.765	0.594
		<b>R.C. (%)</b>	-6%	-12%	<b>R.C. (%)</b>	-2%	-8%

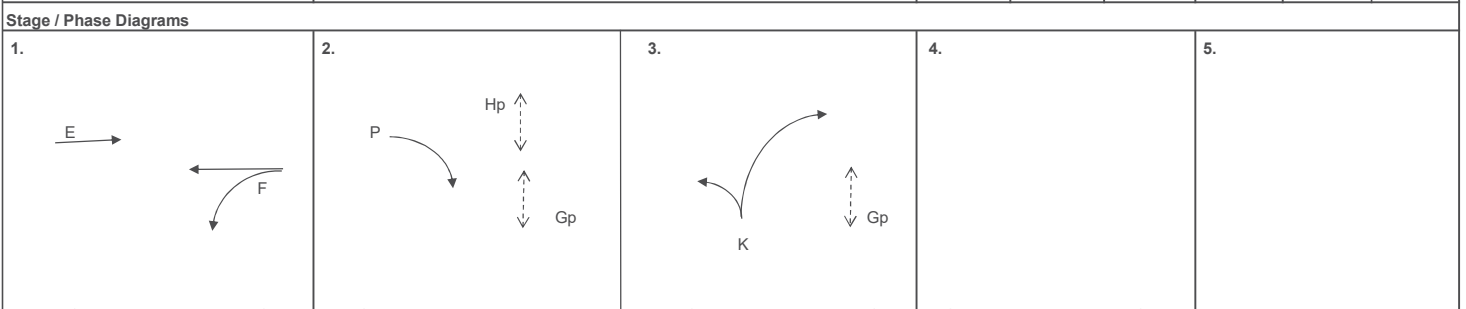

I/G= 7		I/G= 7	20	I/G= 2		I/G=		I/G=	
I/G= 7		I/G= 7	20	I/G= 2		I/G=		I/G=	
<b>Date:</b> JUN, 2022								<b>Junction:</b> Castle Peak Road - Hung Shui Kiu / Fuk Hang Tsuen Road	

(J8)

**TRAFFIC SIGNALS CALCULATION**

Job No.: **CHK50637810**

**MVA HONG KONG LIMITED**

Junction: Castle Peak Road - Hung Shui Kiu / Fuk Hang Tsuen Rd

Design Year: 2034

Description: Design Weekday AM/ PM Peak (Proposed Further Improvement Scheme)

Designed By: HWL

Checked By: TKM

Approach	Movements	Phase	Stage	Width (m)	Radius (m)		Gradient (%)	Pro. Turning (%)		Revised Saturation Flow (pcu/hr)		AM Peak			PM Peak		
					Left	Right		AM	PM	AM	PM	Flow (pcu/hr)	y Value	Critical y	Flow (pcu/hr)	y Value	Critical y
Castle Peak Rd Hung Shui Kiu EB	→ → ↓	E E P	1,4 1,4 2	3,250 3,250 3,000						2080 2080 1870	2080 2080 1870	975 975 240	0.469 0.469 0.128	0.469 0.469 0.128	1000 1000 240	0.481 0.481 0.128	0.481 0.481 0.128
Castle Peak Rd Hung Shui Kiu WB	← ← ←	F F F	1 1 1	3,500 3,500 3,500	15			15%	14%	1935 2105 2105	1935 2105 2105	526 572 572	0.272 0.272 0.272		526 572 572	0.272 0.272 0.272	
Fuk Hang Tsuen Road (NB)	↔ ↔	K K	3 3	3,300 3,300	15 17.5	12.5		76% / 24%	73% / 27%	1770 1905	1770 1905	171 184	0.097 0.097	0.097	137 148	0.077 0.078	0.078 0.078
Pedestrian Crossing		Hp Gp lp	2 2,3 4	MIN GREEN + FLASH =			10 10 5	+ + +	10 10 14	= = =	20 20 19						

<b>Notes:</b>	<b>Flow: (pcu/hr)</b>			<b>Group</b>	E,Hp,K	E,P,K	<b>Group</b>	F,P,K,lp	E,P,K
		<b>y</b>	0.565	0.694	<b>y</b>	0.478	0.687		
		<b>L (sec)</b>	30	13	<b>L (sec)</b>	38	13		
		<b>C (sec)</b>	120	120	<b>C (sec)</b>	120	120		
		<b>y pract.</b>	0.675	0.803	<b>y pract.</b>	0.615	0.803		
		<b>R.C. (%)</b>	19%	16%	<b>R.C. (%)</b>	29%	17%		

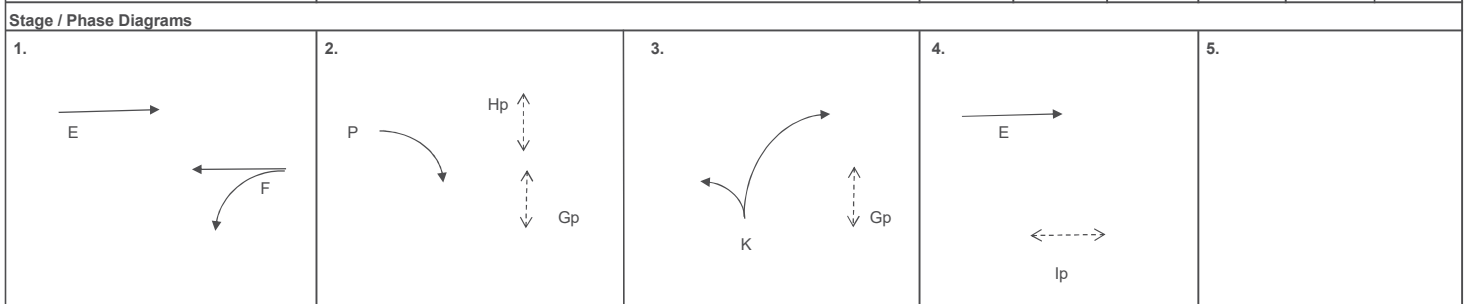

I/G=		I/G= 5		I/G= 6		I/G= 5		I/G=	
I/G=		I/G= 5		I/G= 6		I/G= 5		I/G=	
<b>Date:</b> JUN, 2022							<b>Junction:</b> Castle Peak Road - Hung Shui Kiu / Fuk Hang Tsuen Rd		

(J8)

**TRAFFIC SIGNALS CALCULATION**

Job No.: **CHK50637810**

**MVA HONG KONG LIMITED**

Junction: Castle Peak Road - Hung Tin Road

Design Year: 2034

Description: Design Weekday AM/ PM Peak

Designed By: HWL

Checked By: TKM

Approach	Movements	Phase	Stage	Width (m)	Radius (m)		Gradient (%)	Pro. Turning (%)		Revised Saturation Flow (pcu/hr)		AM Peak			PM Peak		
					Left	Right		AM	PM	AM	PM	Flow (pcu/hr)	y Value	Critical y	Flow (pcu/hr)	y Value	Critical y
Hung Tin Road SB	L	F	2	3.300	12.5					1735	1735	95	0.055		85	0.049	
	↔	F	2	3.500	15	15		0% / 100%	0% / 100%	1915	1915	280	0.146		237	0.124	
	↕	F	2	3.500		12.5				1880	1880	275	0.146		233	0.124	
Castle Peak Road	↖	C	2,3	3.300	22.5					1825	1825	435	0.238	0.238	420	0.230	0.230
Hung Shui Kiu	→	B	3,4	3.650						1980	1980	338	0.171		321	0.162	
EB	→	B	3,4	3.650						2120	2120	362	0.171		344	0.162	
Castle Peak Road	←	D	1,3,4	3.650						1980	1980	340	0.172		268	0.135	
Hung Shui Kiu	←	D	1,3,4	3.650						2120	2120	365	0.172		287	0.135	
WB	↖	E	1	3.400		15				1905	1905	365	0.192	0.192	315	0.165	0.165
LRT (FIXED TIME)		A	4	MIN GREEN + (FLASH + /			20	+	16	=	36			*			*
Pedestrian Crossing	Gp	1	MIN GREEN + FLASH =			5	+	9	=	14							
	Hp	1,2,3	MIN GREEN + FLASH =			5	+	8	=	13							
	lp	1,3,4	MIN GREEN + FLASH =			5	+	9	=	14							
	Jp	4	MIN GREEN + FLASH =			7	+	14	=	21							
	Kp	2	MIN GREEN + FLASH =			8	+	7	=	15							

Notes:	Flow: (pcu/hr)	Group	E,F,Hp,A	E,C,A	Group	E,F,Hp,A	E,C,A
		<b>y</b>	0.338	0.430	<b>y</b>	0.289	0.395
		<b>L (sec)</b>	59	51	<b>L (sec)</b>	57	49
		<b>C (sec)</b>	130	130	<b>C (sec)</b>	130	130
		<b>y pract.</b>	0.492	0.547	<b>y pract.</b>	0.505	0.561
		<b>R.C. (%)</b>	45%	27%	<b>R.C. (%)</b>	75%	42%

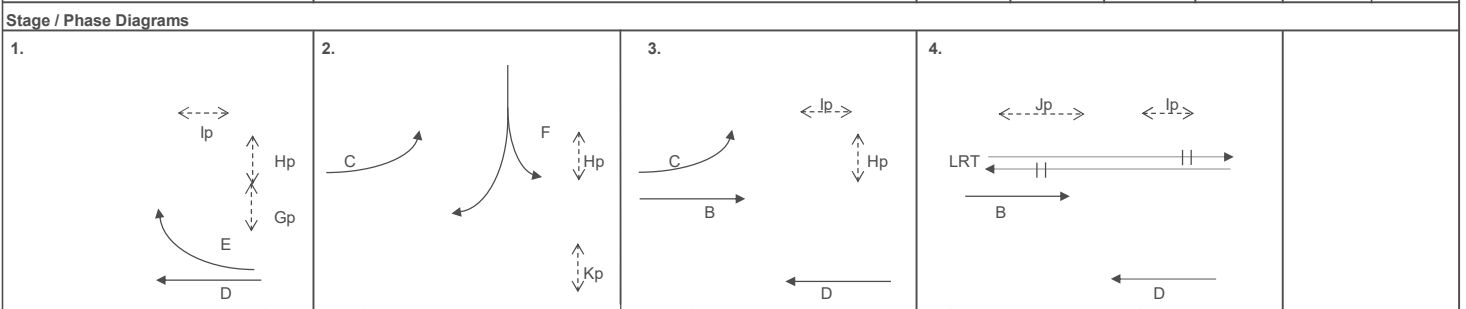

I/G= 2	I/G= 9	I/G=	I/G= 6	36	I/G=
I/G=	I/G= 9	I/G=	I/G= 6	36	I/G=
<b>Date:</b> JUN, 2022			<b>Junction:</b> Castle Peak Road - Hung Tin Road		

## Priority Junction Capacity Calculation

Job Title: CE 92/2017 (CE) Site Formation and Infrastructure Works for Development near Tan Kwai Tsuen, Yuen Long - IDC		Designed by: HWL
Junction: Tan Kwai Tsuen Road - Shui Fu Road (J10)		Checked by: TKM
Scheme: Design Weekday AM/ PM Peak		Date: Jun-22
Design Year: 2034	Job No.: CHK50637810	
Arm A: Tan Kwai Tsuen Road (SB)		
Arm B: Shui Fu Road		
Arm C: Tan Kwai Tsuen Road (NB)		

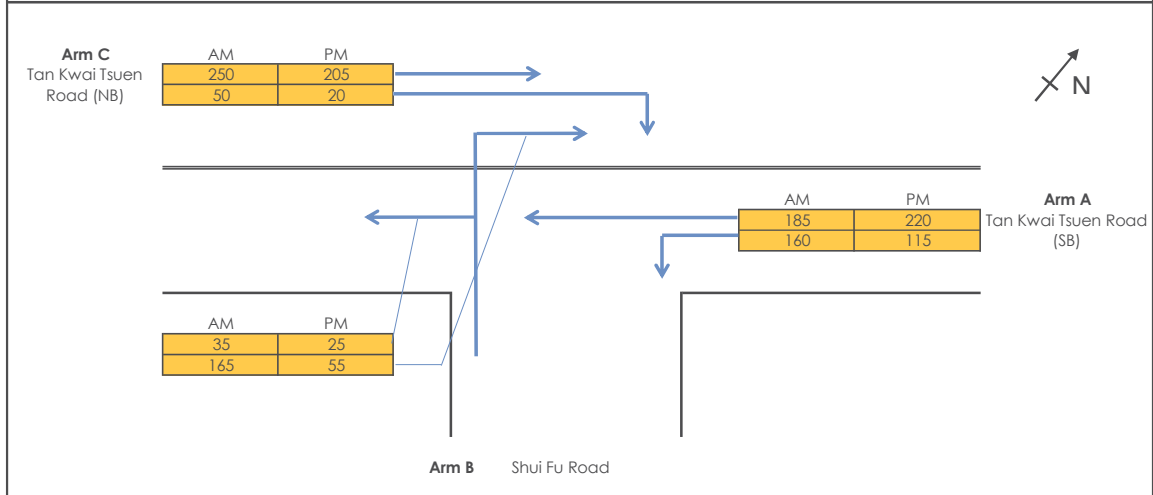

### GEOMETRY

Major Road Width (m)	W	7.25	Lane widths (m)	w(b-a)	3.00
Central Reserve Width (m)	Wcr	0.00		w(b-c)	3.00
Blockage of major road right turn	Y/N?	Y		w(c-b)	3.50
Combined stream on minor arm	Y/N?	Y			
Visibility Distances (m)	Vr(b-a)	80	Calculated Parameters	D	0.867
	VI(b-a)	80		E	0.905
	Vr(b-c)	80		F	0.933
	Vr(c-b)	60		Y	0.75

### ANALYSIS

		AM	PM
TRAFFIC FLOWS (pcu/hr)	q(c-a)	250	205
	q(c-b)	50	20
	q(a-b)	160	115
	q(a-c)	185	220
	q(b-a)	165	55
	q(b-c)	35	25
	f	0.18	0.31
CAPACITIES (pcu/hr)	Q(b-ac)	454	485
	Q(c-a)	1652	1741
	Q(c-b)	607	610
RFC's	c-a	0.15	0.12
	c-b	0.08	0.03
	b-ac	0.44	0.17
<b>RFC</b>		<b>0.44</b>	<b>0.17</b>

Where VI and Vr are visibility distances to the left or right of the respective streams  
 $D = (1 + 0.094(w(b-a) - 3.65))(1 + 0.0009(Vr(b-a) - 120))(1 + 0.0006(VI(b-a) - 150))$   
 $E = (1 + 0.094(w(b-c) - 3.65))(1 + 0.0009(Vr(b-c) - 120))$   
 $F = (1 + 0.094(w(c-b) - 3.65))(1 + 0.0009(Vr(c-b) - 120))$   
 $Y = 1 - 0.0345W$

f = proportion of minor traffic turning left  
 $Q(b-ac) = Q(b-c) * Q(b-a) / (1 - f) * Q(b-c) + f * Q(b-a)$  Capacity of combined streams

All the above formulas are in accordance to T.P.D.M. V.2.4 Appendix 1

# Roundabout Capacity Calculation



Job Title:	CE 92/2017 (CE) Site Formation and Infrastructure Works for Development near Tan Kwai Tsuen, Yuen Long - IDC		Designed by:	HWL
Junction:	J11 - Tin Shui Wai West Interchange (New Roundabout)		Checked by:	TKM
Scheme:	Design Weekday AM Peak		Date:	JUN, 2022
Design Year:	2034	Job No.:	CHK50637810	
Arm A	Yuen Long Highway (Westbound Slip Road)			
Arm B	Road L11			
Arm C	Road L20			
Arm D	Road L22			
Arm E	Hung Tin Road			

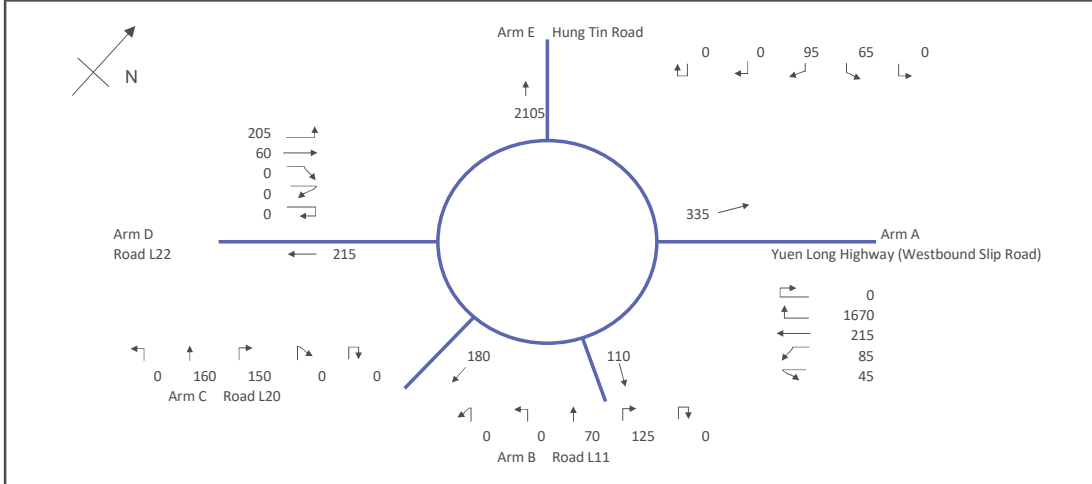

		ENTRY ARM	A	B	C	D	E
<b>INPUT PARAMETERS</b>							
V	Approach Half Width (m)		6.00	5.00	5.40	7.30	5.00
E	Entry Width (m)		8.30	6.20	7.50	10.00	8.50
L	Effective Length of Flare (m)		15.00	20.00	15.00	20.00	20.00
R	Entry Radius (m)		55.00	55.00	50.00	50.00	55.00
D	Inscribed Circle Diameter (m)		90.00	90.00	90.00	90.00	90.00
A	Entry Angle (degree)		20.00	20.00	30.00	30.00	20.00
Q	Entry Flow (pcu/hour)		2,015	195	310	265	160
Qc	Circulating Flow Across Entry (pcu/hour)		160	2,065	2,080	2,175	335
<b>OUTPUT PARAMETERS</b>							
S	= 1.6 (E - V) / L      Sharpness of flare		0.25	0.10	0.22	0.22	0.28
K	= 1 - 0.00347 (A-30) - 0.978 (1/R - 0.05)		1.07	1.07	1.03	1.03	1.07
X2	= V + ((E-V) / (1+2S))		7.54	6.01	6.85	9.19	7.24
M	= EXP ((D-60) / 10)		20.09	20.09	20.09	20.09	20.09
F	= 303 * X2		2286	1820	2076	2783	2195
Td	= 1 + (0.5 / (1+M))		1.02	1.02	1.02	1.02	1.02
Fc	= 0.21 * Td (1 + 0.2 * X2)		0.54	0.47	0.51	0.61	0.53
Qe	= K (F - Fc * Qc)		2344	898	1046	1499	2151
DFC	= Q / Qe	Design Flow / Capacity	0.86	0.22	0.30	0.18	0.07
		Total Entry Flows	2,945				

All the above formulas are in accordance to T.P.D.M. Vol.2 Chp.4 Sec 4.5.9

# Roundabout Capacity Calculation



Job Title:	CE 92/2017 (CE) Site Formation and Infrastructure Works for Development near Tan Kwai Tsuen, Yuen Long - IDC		Designed by:	HWL
Junction:	J11 - Tin Shui Wai West Interchange (New Roundabout)		Checked by:	TKM
Scheme:	Design Weekday PM Peak		Date:	JUN, 2022
Design Year:	2034	Job No.:	CHK50637810	
Arm A	Yuen Long Highway (Westbound Slip Road)			
Arm B	Road L11			
Arm C	Road L20			
Arm D	Road L22			
Arm E	Hung Tin Road			

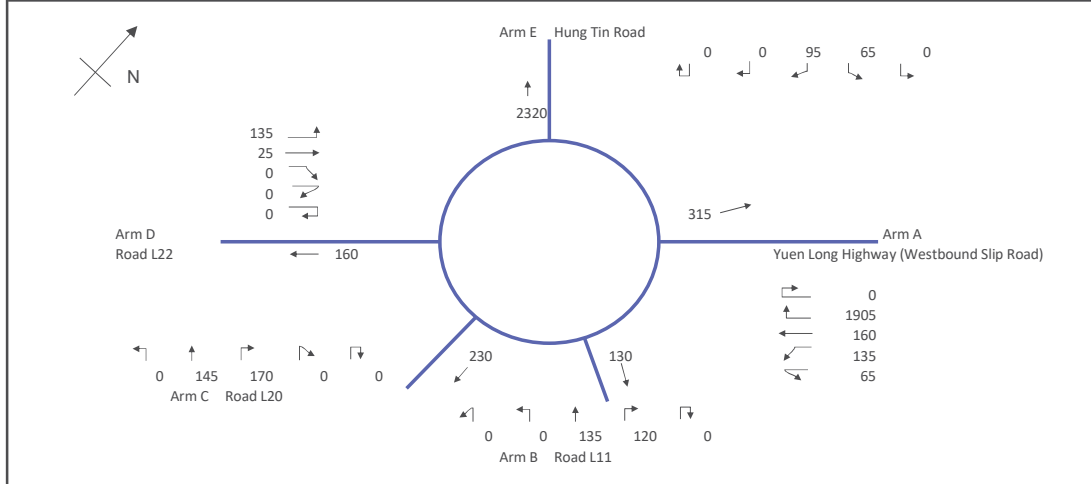

		ENTRY ARM	A	B	C	D	E
<b>INPUT PARAMETERS</b>							
V	Approach Half Width (m)		6.00	5.00	5.40	7.30	5.00
E	Entry Width (m)		8.30	6.20	7.50	10.00	8.50
L	Effective Length of Flare (m)		15.00	20.00	15.00	20.00	20.00
R	Entry Radius (m)		55.00	55.00	50.00	50.00	55.00
D	Inscribed Circle Diameter (m)		90.00	90.00	90.00	90.00	90.00
A	Entry Angle (degree)		20.00	20.00	30.00	30.00	20.00
Q	Entry Flow (pcu/hour)		2,265	255	315	160	160
Qc	Circulating Flow Across Entry (pcu/hour)		160	2,295	2,320	2,475	315
<b>OUTPUT PARAMETERS</b>							
S	= $1.6(E - V) / L$ Sharpness of flare		0.25	0.10	0.22	0.22	0.28
K	= $1 - 0.00347(A-30) - 0.978(1/R - 0.05)$		1.07	1.07	1.03	1.03	1.07
X2	= $V + ((E-V) / (1+2S))$		7.54	6.01	6.85	9.19	7.24
M	= $EXP((D-60)/10)$		20.09	20.09	20.09	20.09	20.09
F	= $303 * X2$		2286	1820	2076	2783	2195
Td	= $1 + (0.5 / (1+M))$		1.02	1.02	1.02	1.02	1.02
Fc	= $0.21 * Td(1 + 0.2 * X2)$		0.54	0.47	0.51	0.61	0.53
Qe	= $K(F - Fc * Qc)$		2344	782	920	1311	2163
DFC	= $Q / Qe$	Design Flow / Capacity	0.97	0.33	0.34	0.12	0.07
		Total Entry Flows	3,155				

All the above formulas are in accordance to T.P.D.M. Vol.2 Chp.4 Sec 4.5.9

**TRAFFIC SIGNALS CALCULATION**

Job No.: **CHK50637810**

**MVA HONG KONG LIMITED**

Junction: Shui Fu Road / Proposed Access Road

Design Year: 2034

Description: Design Weekday AM/ PM Peak

Designed By: HWL

Checked By: TKM

Approach	Movements	Phase	Stage	Width (m)	Radius (m)		Gradient (%)	Pro. Turning (%)		Revised Saturation Flow (pcu/hr)		AM Peak			PM Peak		
					Left	Right		AM	PM	AM	PM	Flow (pcu/hr)	y Value	Critical y	Flow (pcu/hr)	y Value	Critical y
Access Road (WB)	↓	B	2	4,500	7.5			35%	28%	1930	1955	215	0.111	0.111	160	0.082	0.082
Access Road (EB)	↑	A	1	5,000	18			42%	23%	2045	2075	285	0.139	0.139	155	0.075	0.075
Shui Fu Road (Lower section)	↔	C	3	5,000	22.5	15		53% / 47%	71% / 29%	1955	1965	215	0.110	0.110	140	0.071	0.071
Shui Fu Road (Upper section)	↔	D	4	5,000	22.5	12.5		0% / 100%	0% / 100%	1890	1890	10	0.005		5	0.003	
Pedestrian Crossing		Ep	5	MIN GREEN + FLASH =		7	+	9	=	16				*			*
		Fp	5	MIN GREEN + FLASH =		7	+	9	=	16							

Notes:	Flow: (pcu/hr)	Group	A,B,C,D,Ep	A,B,C,D,Ep	Group	A,B,C,D,Ep	A,B,C,D,Ep
		<b>y</b>	0.361	0.361	<b>y</b>	0.228	0.228
		<b>L (sec)</b>	53	53	<b>L (sec)</b>	53	53
		<b>C (sec)</b>	100	100	<b>C (sec)</b>	100	100
		<b>y pract.</b>	0.423	0.423	<b>y pract.</b>	0.423	0.423
		<b>R.C. (%)</b>	17%	17%	<b>R.C. (%)</b>	86%	86%

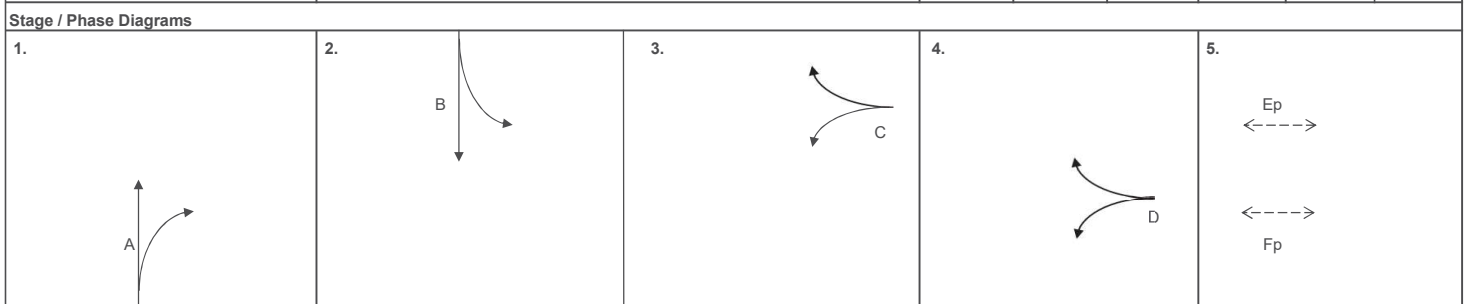

I/G= 7		I/G= 7		I/G= 7		I/G= 7	5	I/G= 7	16
I/G= 7		I/G= 7		I/G= 7		I/G= 7	5	I/G= 7	16
<b>Date:</b> JUN, 2022								<b>Junction:</b> Shui Fu Road / Proposed Access Road	



## **APPENDIX F**

# **Swept Path Analysis**



## **APPENDIX G**

# **Lift Capacity Analysis**

## Appendix G - Calculations of Lift System Capacity

	Lift Tower (LT)	1
Input	Max. number of stops (S)	1
Input	Lift Capacity (Passenger/Lift)	16
	Number of passengers ( <i>N</i> : usually assumed as 80 % of the contract load)	12
	Probably number of stops (SI) $= S - S * ((S - 1) / S) \exp N$	1
Input	Total lift travel (L) in metre	17.5
Input	Rated speed (V) in m/s (refer to Guidelines on Energy Efficiency of Lift & Escalator Installtions, 2007 published by EMSD)	1.6
	Total upward journey time (Tup) in sec $= SI * (L / (SI * V) + 2V)$	14.1
	Total downward journey time (Tdown) in sec $= (L / V) + 2V$	14.1
Input	Width of door opening (W) in metre	1.1
	Door operation speed (Vdoor) in m/s	0.2
Input	Central Door Opening (C) / Side Door Opening (S)	C
	Door operation time (Tdoor) in sec <i>For Side Door Opening:</i> $= 2 * (SI + 1) * (W / V_{door})$ ; <i>For Central Door Opening:</i> $= 2 * (SI + 1) * (W / V_{door} * 2)$	11
	Total passenger transfer time (Tt) in sec $= (2 * N)$	24
	Round trip time (Tr) in sec $= (T_{up} + T_{down} + T_{door} + T_t)$	63
Input	Number of Lift (J)	2
	Capacity of lift system for passenger in 5 minutes (U) $= (300 * J * N) / Tr$	114
	Interval for group / lift bank in sec $= Tr / J$	32
	<b>One-way passenger capacity per hour</b> $= U * 60 / 5$	<b>1,370</b>

# **APPENDIX H**

## **Preliminary Layout for Traditional and Sawtooth Type PTI**

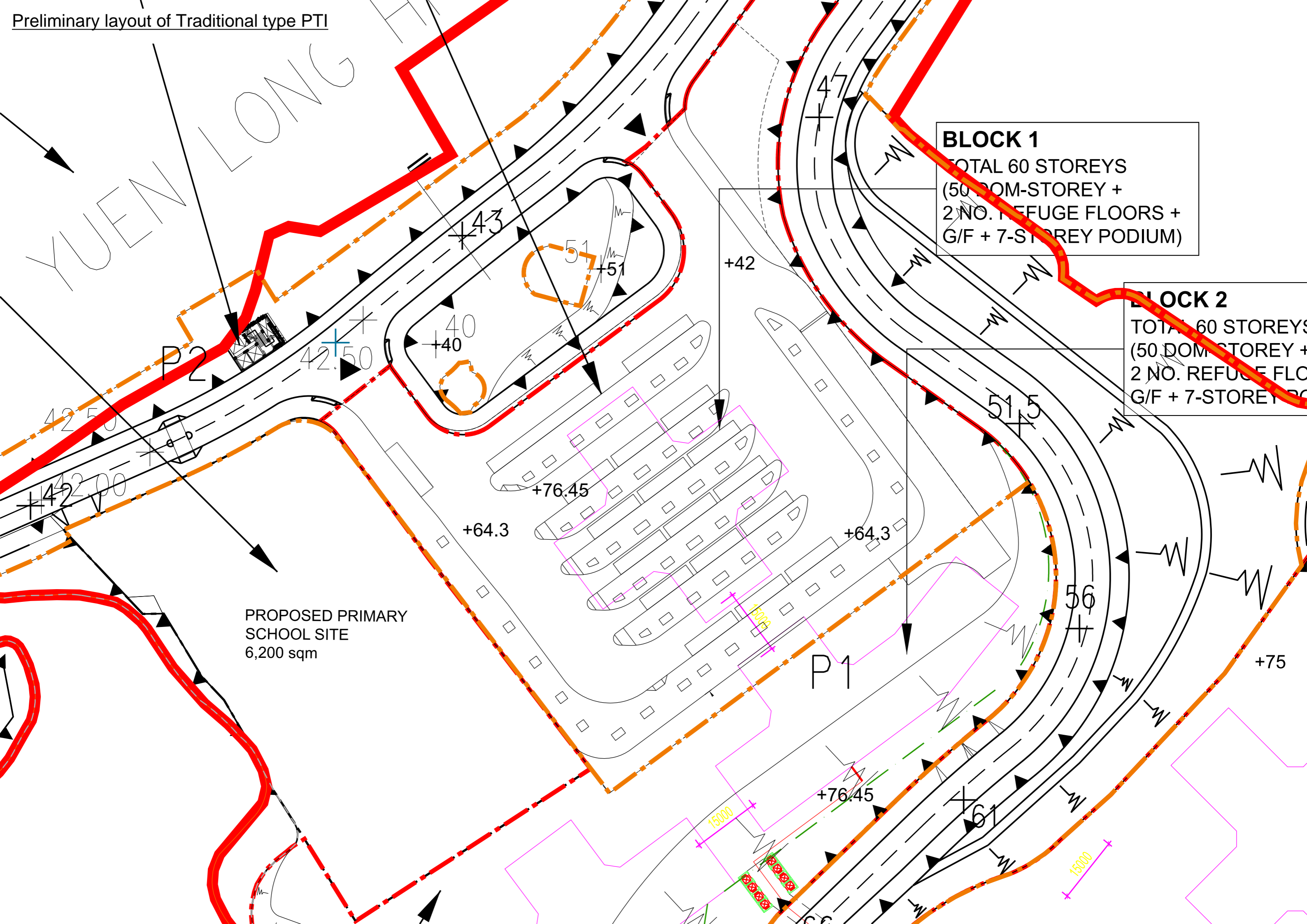

**BLOCK 1**  
TOTAL 60 STOREYS  
(50 DOM-STOREY +  
2 NO. REFUGE FLOORS +  
G/F + 7-STOREY PODIUM)

**BLOCK 2**  
TOTAL 60 STOREYS  
(50 DOM-STOREY +  
2 NO. REFUGE FLOORS +  
G/F + 7-STOREY PODIUM)

PROPOSED PRIMARY  
SCHOOL SITE  
6,200 sqm

YUEN LONG

P2

P1

CC

+43

+51

+40

+42.50

+42.50

+42.00

+76.45

+64.3

+64.3

+51.5

+45

+56

+75

+76.45

+61

15000

15000

YUEN LONG HIGHWAY

ENTRANCE  
(PTI & EVA)

**BLOCK 1**  
TOTAL 60 STOREYS  
(50 DOM-STOREY +  
2 NO. REFUGE FLOORS +  
G/F + 7-STOREY PODIUM)

**BLOCK 2**  
TOTAL 60 STOREYS  
(50 DOM-STOREY +  
2 NO. REFUGE FLOOR  
G/F + 7-STOREY PODIUM)

PROPOSED PRIMARY  
SCHOOL SITE  
6,200 sqm

PHASE 3 - PRH

The extent of sawtooth  
PTI will exceed the  
gazette boundary which  
may affect school site  
and housing block layout

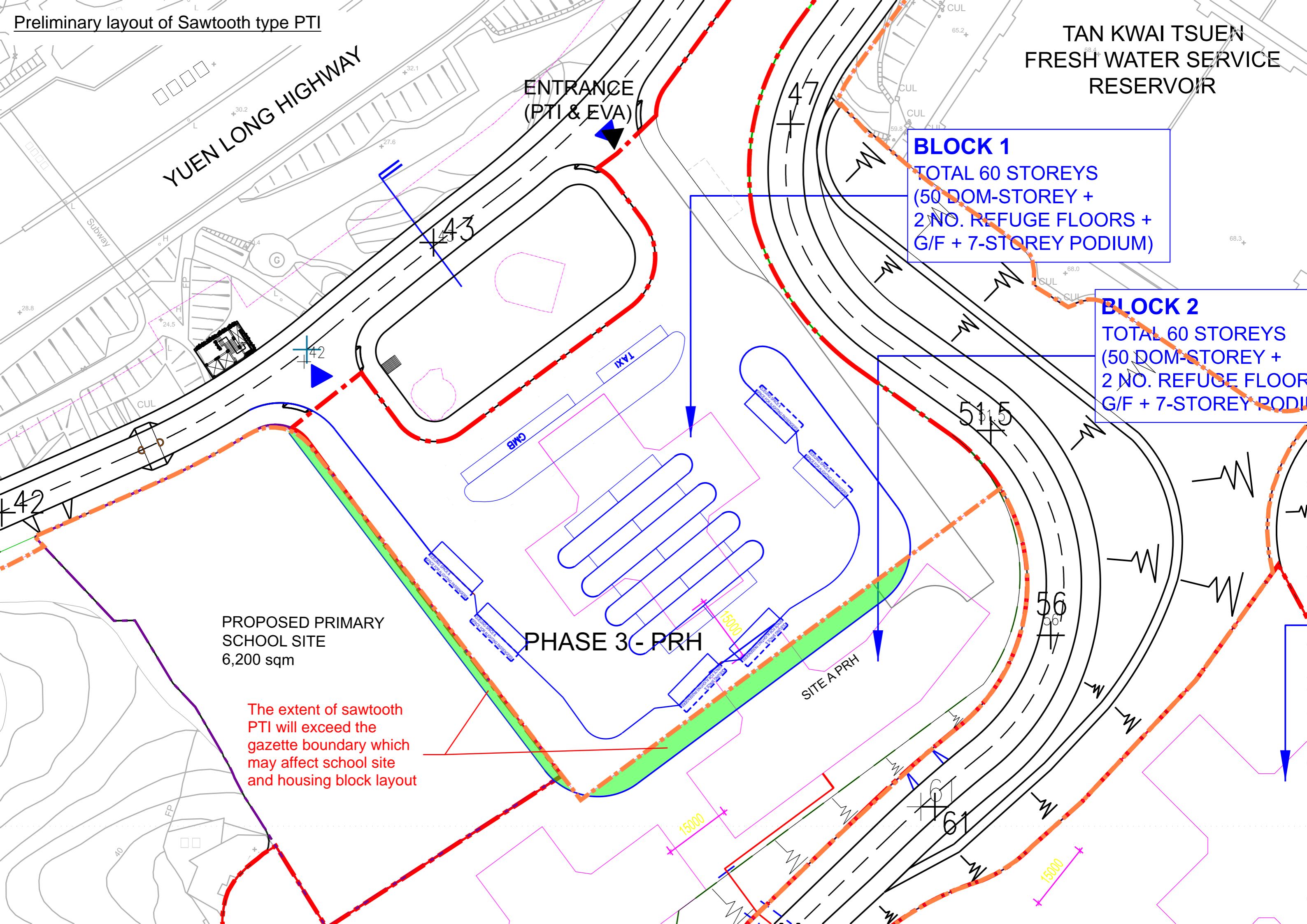

# **APPENDIX I**

## **Planned Roundabout near Tin Shui Wai West Interchange**



# Implementation Plan of TSWW Interchange

- Stage 2 Phase 1
- Stage 2 Phase 2 (part of TSWW) as shown below to be completed by end of 2031)
- Stage 4

