

Government of Hong Kong
Highways Department

LANTAU FIXED CROSSING



Environmental Assessment

Final Report

RECEIVED Volume 1

Agreement No. CE/11/78

Mott MacDonald Hong Kong Ltd.

in association with

Harris & Sutherland (Far East)

L. G. Mouchel & Partners (Asia)

**LANTAU FIXED CROSSING
AGREEMENT NO. CE/11/78**

ENVIRONMENTAL ASSESSMENT

FINAL REPORT

VOLUME 1

TABLE OF CONTENTS

	Page
1. INTRODUCTION	1.1
1.1 Background	1.1
1.2 Synopsis	1.2
1.2.1 Objectives of the Environmental Planning Assessment	1.2
1.2.2 Methodology	1.2
1.2.3 Air Quality	1.3
1.2.4 Water Quality	1.4
1.2.5 Noise Pollution	1.8
1.2.6 Visual Impacts	1.11
1.2.7 Land Use Impacts	1.11
1.2.8 Recommendations in the EPA	1.12
2. AIR QUALITY	2.1
2.1 Introduction	2.1
2.2 Background	2.1
2.3 Air Sensitive Receivers	2.2
2.4 Meteorological Data	2.3
2.5 Methodology for the Construction Phase Assessment	2.3
2.5.1 Modelling Techniques	2.4
2.5.2 Wind Conditions	2.4
2.5.3 Emission Factors	2.5
2.5.4 Construction Activities for the LFC	2.5
2.5.5 Construction Activities for Route 3	2.6
2.5.6 Works Areas	2.6
2.6 Assessment of Construction of the LFC excluding the North Lantau Road	2.6
2.6.1 Predicted Dust Levels	2.6
2.6.2 Mitigation Measures	2.10
2.7 Assessment of Construction of the LFC including the North Lantau Road	2.11
2.7.1 Introduction	2.11
2.7.2 1 Hour Dust Levels	2.11
2.7.3 24 Hour Dust Levels	2.16
2.7.4 Mitigation Measures	2.16
2.8 Operational Phase Assessment	2.17
2.8.1 Methodology	2.17
2.8.2 Operation Stage Impact Assessment and Evaluation	2.18
2.8.3 Combined Operation Stage Impacts from Route 3	2.19
2.8.4 Mitigation Measures during Operation	2.19

	Page
3. WATER QUALITY	3.1
3.1 Background	3.1
3.2 Extension of the Tung Wan Embayment	3.2
3.3 Penny's Bay Works Site	3.4
3.4 Kap Shui Mun Works Sites	3.6
3.5 Underwater Blasting	3.8
3.6 Disposal of Dredged Materials	3.8
3.7 Monitoring during Construction	3.8
3.8 Environmental Audit	3.9
4. CONSTRUCTION NOISE	4.1
4.1 Introduction	4.1
4.2 The EXCO Exemption	4.1
4.3 Methodology	4.2
4.4 Construction Activities	4.6
4.5 Sensitive Receivers	4.6
4.6 Acceptable Noise Levels	4.7
4.7 Noise from Construction of the Tsing Ma Bridge	4.8
4.7.1 General	4.8
4.7.2 Impacts during Period 1	4.11
4.7.3 Impacts during Period 2	4.11
4.7.4 Noise Mitigation at Receivers	4.11
4.7.5 Conclusions and Recommendations	4.15
4.8 Noise from the Construction of the Kap Shui Mun Bridge/ Ma Wan Viaducts	4.15
4.8.1 General	4.15
4.8.2 Impacts during Period 1	4.19
4.8.3 Impacts during Period 2	4.26
4.8.4 Noise Mitigation at Receivers	4.26
4.8.5 Conclusions and Recommendations	4.26
5. RAILWAY NOISE	5.1
5.1 Introduction	5.1
5.2 Tsing Ma Bridge	5.1
5.2.1 Introduction	5.1
5.2.2 Trackform Options Considered	5.1
5.2.3 Acoustic Considerations	5.3
5.2.4 Engineering Aspects	5.5
5.3 Kap Shui Mun Bridge and Ma Wan Viaducts	5.7
5.3.1 Environmental Reference Scheme	5.7
5.3.2 Technical Decisions	5.8
5.3.3 Predicted Noise Levels	5.10
5.3.4 Conclusions	5.12
6. LAND USE	6.1
6.1 Afteruse of Project Works Sites	6.1
6.2 Potential Afteruses	6.1

LIST OF TABLES

	Page	
2.1	Background Levels of Air Pollution at East Tsing Yi	2.2
2.2	Air Quality Data Collected at Tung Chung	2.2
2.3	Air Quality Objectives	2.4
2.4	Maximum Predicted TSP Levels (Without Mitigation)	2.7
2.5	Maximum Predicted RSP Levels (Without Mitigation)	2.8
2.6	Summary of the Percentage Exceedance of 24-Hour AQO during Construction (Without Mitigation)	2.10
2.7	Highest 1-Hr TSP ($\mu\text{g}/\text{m}^3$) Concentration for the North Lantau Road - Background Level Excluded (Without Mitigation)	2.12
2.8	Combined 1-Hr TSP ($\mu\text{g}/\text{m}^3$) Concentration - Background Level Included (Without Mitigation)	2.12
2.9	Combined 1-Hr TSP ($\mu\text{g}/\text{m}^3$) Concentration - Background Level Included (With Mitigation)	2.12
2.10	Highest 1-Hr RSP ($\mu\text{g}/\text{m}^3$) Concentration for the North Lantau Road - Background Level Excluded (Without Mitigation)	2.13
2.11	Combined 1-Hr RSP ($\mu\text{g}/\text{m}^3$) Concentration - Background Level Included (Without Mitigation)	2.13
2.12	Combined 1-Hr RSP ($\mu\text{g}/\text{m}^3$) Concentration - Background Level Included (With Mitigation)	2.13
2.13	24-Hr Averaged TSP ($\mu\text{g}/\text{m}^3$) Concentration for the North Lantau Road - Background Level Excluded (Without Mitigation)	2.14
2.14	Combined 24-Hr Averaged TSP ($\mu\text{g}/\text{m}^3$) Concentration - Background Level Excluded (Without Mitigation)	2.14
2.15	Combined 24-Hour Averaged TSP ($\mu\text{g}/\text{m}^3$) Concentration - Background Level Excluded (With Mitigation)	2.14
2.16	24-Hr Averaged RSP ($\mu\text{g}/\text{m}^3$) Concentration for the North Lantau Road - Background Level Excluded (Without Mitigation)	2.15
2.17	Combined 24-Hr Averaged RSP ($\mu\text{g}/\text{m}^3$) Concentration - Background Level Excluded (Without Mitigation)	2.15
2.18	Combined 24-Hr Averaged RSP ($\mu\text{g}/\text{m}^3$) Concentration - Background Level Excluded (With Mitigation)	2.15
2.19	Average Traffic Mix	2.17
2.20	Traffic Flow during Operation Phase	2.17
2.21	Modelling Results - Operation Stage (including background)	2.18
3.1	Net Velocity Vectors of Stations 1, 4 and 6 on Neap and Spring Tide Cycles at Tung Wan Bay	3.3
3.2	Net Velocity Vectors of Stations 1, 3 and 7 on Neap and Spring Tide Cycles at Kap Shui Mun	3.7

	Page	
4.1	Noise Mitigation	4.5
4.2	Sensitive Receivers	4.7
4.3	Area Sensitivity Ratings (ASRs)	4.8
4.4	Basic Noise Levels (BNLs)	4.8
4.5	Sound Power Levels from Tsing Ma Bridge/Ma Wan Substructure	4.9
4.6	Sound Power Levels from Tsing Ma Bridge/Tower Construction	4.9
4.7	Sound Power Levels from Tsing Ma Bridge/Tsing Yi Substructure	4.10
4.8	Sound Power Levels from Tsing Ma Bridge/Suspension Cables	4.10
4.9	Sound Power Levels from Tsing Ma Bridge/Deck Superstructure	4.10
4.10	Tsing Ma Bridge Construction Noise - Without Mitigation	4.12
4.11	Exceedance of ANL for Period 1 - with Mitigation Methods A, B and C	4.13
4.12	Exceedance of ANL for Period 2 - with Mitigation Methods A, B and C	4.14
4.13	Maximum Noise Levels for the Tsing Ma Bridge Contract	4.15
4.14	Sound Power Levels from Kap Shui Mun Bridge/Lantau Works Site	4.15
4.15	Sound Power Levels from Kap Shui Mun Bridge/Ma Wan Works Site	4.16
4.16	Sound Power Levels from Kap Shui Mun Bridge/Lantau Anchorage	4.16
4.17	Sound Power Levels from Kap Shui Mun Bridge/Ma Wan Anchorage	4.16
4.18	Sound Power Levels from Kap Shui Mun Bridge/Lantau Tower	4.17
4.19	Sound Power Levels from Kap Shui Mun Bridge/Ma Wan Tower	4.17
4.20	Sound Power Levels from Kap Shui Mun Bridge/Lantau Pier	4.17
4.21	Sound Power Levels from Kap Shui Mun Bridge/Ma Wan Pier	4.18
4.22	Sound Power Levels from Kap Shui Mun Bridge/Deck Superstructure	4.18
4.23	Sound Power Levels from Ma Wan Viaducts/Piers A to H	4.18
4.24	Sound Power Levels from Ma Wan Viaducts/Works Area and Haul Road	4.19
4.25	Kap Shui Mun Bridge Construction Noise - Without Mitigation	4.20
4.26	Exceedance of ANL for Period 1 for the Kap Shui Mun Bridge - with Mitigation Methods A, B and C	4.21
4.27	Exceedance of ANL for Period 2 for the Kap Shui Mun Bridge - with Mitigation Methods A, B and C	4.22
4.28	Ma Wan Viaducts Construction Noise - without Mitigation	4.23
4.29	Exceedance of ANL for Period 1 for the Ma Wan Viaducts - with Mitigation Methods A, B and C	4.24
4.30	Exceedance of ANL for Period 2 for the Ma Wan Viaducts - with Mitigation Methods A, B and C	4.25
4.31	Maximum Noise Levels for the Kap Shui Mun/Ma Wan Viaducts Contracts	4.26
5.1	Predicted Facade Noise Levels	5.11

LIST OF FIGURES

- 2.1 Study Area and Locations of Sensitive Receivers
- 2.2 Key Construction Activities during Period 1 Excluding NLR
- 2.3 Key Construction Activities during Period 2 Excluding NLR
- 2.4 Key Construction Activities during Period 3 Excluding NLR
- 2.5 Key Construction Activities during North Lantau Road Construction
- 2.6 Highest 1-Hour TSP Level Distribution during Period 1 Excluding NLR
- 2.7 Highest 1-Hour RSP Level Distribution during Period 1 Excluding NLR
- 2.8 Highest 1-Hour TSP Level Distribution during Period 2 Excluding NLR
- 2.9 Highest 1-Hour RSP Level Distribution during Period 2 Excluding NLR
- 2.10 Highest 1-Hour TSP Level Distribution during Period 3 Excluding NLR
- 2.11 Highest 1-Hour RSP Level Distribution during Period 3 Excluding NLR
- 2.12 Predicted 24-Hour TSP Concentration in Period 1 Excluding NLR
- 2.13 Predicted 24-Hour RSP Concentration in Period 1 Excluding NLR
- 2.14 Predicted 24-Hour TSP Concentration in Period 2 Excluding NLR
- 2.15 Predicted 24-Hour RSP Concentration in Period 2 Excluding NLR
- 2.16 Predicted 24-Hour TSP Concentration in Period 3 Excluding NLR
- 2.17 Predicted 24-Hour RSP Concentration in Period 3 Excluding NLR
- 2.18 Highest 1-Hour TSP Level Distribution during Period 3 Including NLR
- 2.19 Highest 1-Hour RSP Level Distribution during Period 3 Including NLR
- 2.20 Highest 1-Hour TSP Level Distribution during Period 3 Including NLR With Mitigation
- 2.21 Highest 1-Hour RSP Level Distribution during Period 3 Including NLR With Mitigation
- 2.22 24-Hour Average TSP Distribution during Period 3 Including NLR
- 2.23 24-Hour Average RSP Distribution during Period 3 Including NLR
- 2.24 24-Hour Average TSP Distribution during Period 3 Including NLR With Mitigation
- 2.25 24-Hour Average RSP Distribution during Period 3 Including NLR With Mitigation
- 2.26 Predicted 24-Hour TSP Concentration in Period 3 Including NLR
- 2.27 Predicted 24-Hour RSP Concentration in Period 3 Including NLR
- 2.28 Predicted 24-Hour TSP Concentration in Period 3 Including NLR With Mitigation
- 2.29 Predicted 24-Hour RSP Concentration in Period 3 Including NLR With Mitigation
- 2.30 Cross Section of Predicted NO₂ Concentration Downwind of the LFC
- 2.31 Cross Section of Predicted RSP Concentration Downwind of the LFC
- 2.32 1-Hour Average CO Concentration during Operation
- 2.33 8-Hour Average CO Concentration during Operation
- 2.34 1-Hour Average NO₂ Concentration during Operation
- 2.35 24-Hour Average NO₂ Concentration during Operation
- 2.36 24-Hour Average RSP Concentration during Operation

- 3.1 Tsing Ma Bridge Ma Wan Works Site
- 3.2 Penny's Bay Works Site
- 3.3 Kap Shui Mun Channel Works Site

- 4.1 Lantau Fixed Crossing
- 4.2 Tsing Ma Bridge
- 4.3 Typical Deck Layout
- 4.4 Assumed Construction Programme - Tsing Ma Bridge
- 4.5 Assumed Construction Programme - Kap Shui Mun Bridge
- 4.6a Assumed Construction Programme - Ma Wan Viaducts
- 4.6b Assumed Construction Programme - Ma Wan Viaducts
- 4.7 Location of Noise Sensitive Receivers

- 5.1 Trackform for Tsing Ma Bridge - Case I Plan
- 5.2 Trackform for Tsing Ma Bridge - Case II Typical Section
- 5.3 Lantau Fixed Crossing Proposed Baseplate and Block Assembly
- 5.4 Lantau Fixed Crossing Proposed Baseplate and Block Assembly
- 5.5 Lantau Fixed Crossing Proposed Baseplate and Block Assembly
- 5.6 Typical Section through Resiliently Mounted Rail Bearer
- 5.7 Section on Gauge Tie
- 5.8 Cross Section on Waybeam Diaphragm
- 5.9 Section through Main/Intermediate Frame Showing Arrangement for Lateral Restraint of Rail Bearers
- 5.10 Elevation on Rail Waybeams Showing Details of Rail Bearers and Supports
- 5.11 Approximate Position of Selected Properties on Ma Wan and Lantau

1. Introduction

LANTAU FIXED CROSSING
ENVIRONMENTAL ASSESSMENT
FINAL REPORT

1. INTRODUCTION

1.1 Background

The Lantau Fixed Crossing (LFC) is one of the key components of the Airport Core Programme (ACP) leading to the opening of the New Airport at Chek Lap Kok. The LFC will carry the dual three lane expressway and the Airport Railway between the island of Tsing Yi and North Lantau.

The LFC as considered in this report includes the following:-

- (a) the Tsing Ma Bridge;
- (b) the Ma Wan Viaduct;
- (c) the Kap Shui Mun Bridge; and
- (d) the North Lantau Road connecting the Kap Shui Mun Bridge to the toll plaza.

The LFC will connect with Route 3 on Tsing Yi. This is a separate project but it is discussed in this report where combined impacts are of importance.

An environmental impact assessment has been carried out on the LFC in two stages. The first stage comprised an Environmental Planning Assessment (EPA) and included an Initial Assessment Report and a series of Topic Reports covering air, water, noise and visual impacts. A Summary Report summarised the findings of the first stage. A synopsis of the EPA is included in this report as Section 1.2.

A number of key issues were identified during the EPA that needed further study before completion of engineering designs. A focused environmental assessment has therefore been carried out of these issues in parallel with the development of the designs. Interim reports have given conclusions of the studies as they have been developed. Comments have been received on these interim reports and this present report comprises a collation of the interim reports amended in response to the comments.

This report does not cover a full environmental assessment of the LFC and must be read together with the EPA reports.

An Executive Summary has been prepared which summarises the assessment carried out and the main findings.

The topics that have been considered in this stage of the environmental assessment and which are covered in this report are:-

- (a) impacts on air quality during construction and operation;
- (b) impacts on water quality from the works necessary for the bridge foundations;

- (c) construction noise;
- (d) noise from trains crossing the LFC;
- (e) visual impact.

The report comprises this main volume and a separate volume of appendices giving technical details of the assessment.

1.2 Synopsis of the Environmental Planning Assessment

1.2.1 Objectives of the Environmental Planning Assessment

The Environmental Planning Assessment (EPA) of the Lantau Fixed Crossing (LFC) comprised two stages. The first stage, Topic Report 1, "Scoping", (TR1), was a qualitative assessment of the project and identified the potential environmental impacts of two proposed schemes. The second stage evaluated the environmental impacts identified in TR1 and presented the results and conclusions in the following reports:

- TR2: Air Quality Assessment;
- TR3: Water Quality Assessment;
- TR4: Noise Pollution Assessment; and
- TR5: Visual Impact and Land Use Assessment.

The impacts of the schemes were assessed against the Hong Kong Planning Standards and Guidelines (HKPSG) and, where appropriate, the environmental pollution control ordinances. Suitable mitigation measures were then recommended where necessary.

The schemes considered in the EPA comprised the Basic Scheme of a bridge over the Ma Wan Channel and the Alternative Scheme of a submerged tube tunnel crossing the Ma Wan Channel. Each scheme included a viaduct across Ma Wan, a bridge across the Kap Shui Mun Channel and a deep cutting on North Lantau.

The EPA was used as one of the guidelines in determining the route of the crossing and the Basic Scheme was chosen in preference to the Alternative Scheme. The EPA had itself concluded the Basic Scheme as the preferred concept on the basis that the environmental impacts would be less than the Alternative Scheme. Consequently only the Basic Scheme is discussed in this synopsis.

The final stage of the environmental assessment for the LFC is discussed later in this report and comprises a focused assessment of the key issues requiring further consideration following the EPA.

The objective of this synopsis is to summarise the EPA by quantifying what the impacts will be from the LFC, how they can be minimised, and what the impact will be following mitigation. Topic Reports 1 to 5 and the EPA summary report should be referred to for further details.

1.2.2 Methodology

Computer modelling of the potential environmental impacts was used to predict the worst case pollution levels during construction and operation at the worst affected sensitive receivers which were identified according to the HKPSG.

Modelling of the construction phase assessed the worst case by developing a construction programme which generally assumed that all construction activities which could be active at any particular period in the programme would work in parallel. The calculated impacts therefore applied equally to daytime and nighttime working. No mitigation of potential impacts was also assumed in the initial model runs.

In modelling the impacts of the operational phase the EPA used a design horizon of 2006 when the LFC should be working close to capacity.

A design has been prepared for the Tsing Ma Bridge and therefore details of the bridge are known. Details of the method of construction will be determined by the contractor who wins the tender for the bridge but reasonable estimates of construction methods can be made. The Kap Shui Mun Bridge and Ma Wan Viaducts will be contractor designs and therefore neither the design details nor methods of construction are known at the present time. The assessment has been based on the best estimates possible but the final form and implementation of recommendations will depend on the contractors' proposals, particularly if the final form of the structures differs radically from that assumed. In this case the contractor will need to carry out his own environmental impact assessment of his design.

1.2.3 Air Quality

The impacts on air quality were modelled and assessed against the Hong Kong Air Quality Objectives (AQOs).

Construction Phase Impacts

The EPA concluded that the most significant source of particulates during construction will be blasting with further significant contributions from vehicles using haul roads, drilling, and concrete batching.

Dust levels during construction were predicted to be well in excess of the AQOs at all Air Sensitive Receivers (ASRs) (assuming no mitigation of the dust at source). The highest levels were predicted close to the works sites on Ma Wan where there will be excavation by blasting and on North Lantau Island close to the excavation for the cutting. Mitigation of impacts from dust have been considered in subsequent stages of the environmental assessment (see Chapter 2 of this report).

Other pollution from vehicles using the haul roads will be mainly nitrogen dioxide (NO₂). The EPA predicted no significant increase above the ambient levels.

Operation Phase Impacts

During operation of the LFC the maximum levels at ASRs of carbon monoxide (CO), NO₂, and lead (Pb) from vehicles crossing the LFC were predicted to be well within the AQOs.

The area where vehicle emission levels are likely to be high and possibly unacceptable is at the toll plaza on North Lantau. Modelling had assumed that traffic would be travelling at a speed of 25 km/hr on the toll plaza with the result that air quality was within the AQOs. However, in reality traffic is likely to be slower with idling and accelerating motors probably resulting in much higher levels of pollution. This could affect workers at the toll booths although motorists driving through would only be exposed to high pollution levels for a short period of time. The impact would thus be small.

It should be noted that in 2006 traffic emissions are likely to change as a result of the introduction and enforcement of legislative controls which may result in a lowering of the baseline levels.

Mitigation of Impacts

A rigorous dust control programme will be required during construction to reduce the dust levels to comply with the AQOs. Measures to minimise dust generation should include the following:

- (a) stockpiled materials should be shielded and protected from the wind during storage, handling, and transportation;
- (b) batched concrete should be transported via pipeline rather than concrete lorries. Storage of cement should be in closed silos and sand and aggregate should be stored in bunkers;
- (c) blasting should be carefully scheduled and use the minimum practicable charge and blasting mats;
- (d) rock drilling should include dust extraction equipment;
- (e) haul roads should be sprayed with water or sealed. Vehicle movements and speeds should be restricted. Care should be taken in the loading and transportation of materials; and
- (f) conveyor systems should be used to transport materials where practicable. Conveyor belts and points need shielding from the wind.

The impact on workers at the toll plaza could be reduced by use of automatic toll collection, positive ventilation in the toll booths or by designing the plaza to maximise dispersion of emissions.

The recommended mitigation measures should reduce the particulate and emission levels during construction and operation to comply with the AQOs.

Dust during construction has been subsequently considered in further detail (see Chapter 2 of this report). Monitoring of dust levels will be carried out throughout the construction and the contractor will have to apply strict dust control to minimise nuisance.

1.2.4 Water Quality

The Study Area is located within the proposed Western Buffer Water Control Zone. Target levels for water quality were recommended in the EPA based on existing data and the beneficial uses and Water Quality Objectives (WQOs) for the Western Buffer Zone.

The main sensitive receivers are the fish culture zone at Kung Tsai Wan and the bathing beach at Tung Wan. There could also be alterations to water movements and subsequent changes in water quality in the Water Control Zone.

Initial baseline water and sediment quality monitoring showed that the beach water was generally good and improving with E coli and dissolved oxygen levels complying with the WQOs. The E coli and dissolved oxygen levels for marine water also complied with the WQOs but the objectives for ammonia were exceeded. Water at the Kung Tsai Wan fish culture zone was well oxygenated although there were high suspended sediment levels from nearby dredging.

Standards for contamination of sediments were taken as those recommended in the Contaminated Spoil Management Study. Sediment sampling and analysis of metal concentrations showed no exceedance of these except for one sample to the north of the proposed works. Further testing and sampling was recommended if dredging in this area is required.

Construction Phase Impacts

The EPA identified a number of activities which could cause impacts at the sensitive receivers.

Excavation and Dredging

The major concern is the potential for release of sediment into the water column during excavation and dredging resulting in a short but sharp impact and possibly a cause for complaint.

(a) Tsing Ma Bridge

It is likely that excavation off To Kei Kung Kok for the Tsing Ma Bridge will take place after construction of the ship protection structure and consequently there will be only very limited release of sediment into the water column.

Alternatively excavation could be carried out underwater using a drilling platform accompanied by dredging. Some sediment will be released into the column during excavation by this method but as the tidal currents in this area are weak the impact will be localised. It should be noted that currents are strong through the Ma Wan and Kap Shui Mun Channels but weak close to the shore in Tung Wan Bay. Movement of sediments in this area will thus be dependent on winds and waves rather than currents. Suspended sediment could have some impact on Tung Wan Beach depending on the strength and direction of the local winds. The greater impact is likely to occur on a stronger flood tide in the form of discolouration of the water but there will be no health effects.

Excavation for the eastern anchorage of the Tsing Ma Bridge will be land based and the only impacts will be from sediment laden run off reaching the adjacent water bodies.

(b) Kap Shui Mun Bridge

Construction of the Kap Shui Mun Bridge will be based around two work sites requiring barge mooring facilities. Dredging and possibly underwater drilling and blasting will be necessary for their construction.

If significant quantities of sediment are released from dredging operations the high velocity currents in the Kap Shui Mun Channel will increase the potential for impacts. On a flood tide there could be a "flash" impact at the Kung Tsai Wan fish culture zone, 200 m to the north. Suspended solids concentrations may increase in excess of the WQOs and reduce oxygen levels, and increased metal concentrations and organics could be released from the marine mud. Blasting could cause an impact the fish culture zone.

Work Sites

Five waterfront work sites have been proposed for construction of the LFC. Site construction and associated barge mooring facilities will require reclamation but the impact on water quality and water movements is not expected to be significant.

On site activities will generally comprise handling and stockpiling of materials and equipment. Consequent sources of pollution will thus be limited to domestic sewage and site drainage which may contain surficial erosion and runoff water contaminated with oils, greases, and lubricants from vehicle maintenance.

Accidental spillages and discharges of untreated washout water from barge mounted batching plants could impact water quality increasing the pH, turbidity, and suspended solids concentrations.

Two possible locations for an offside works area have been identified in Penny's Bay, neither of which are likely to have a significant impact during construction. Any reduction in the water quality of Penny's Bay will be temporary.

Disposal of dredging spoil

A disposal strategy has been developed for the surplus material. Marine deposits could be used to infill old borrow areas or be disposed of at one of the Government gazetted spoil grounds. Rock based materials and alluvial deposits could be used for construction purposes elsewhere in the Territory.

Water Courses

Some local streams and water courses will have to be diverted during construction but no areas of special ecological significance are likely to be destroyed.

Operational Phase Impacts

Drainage

Spillages of oil based or other harmful substances into the water below the bridge during operation could have an impact on the water quality. However the frequency of spillages is likely to be low and dangerous hazardous goods are likely to be banned from the bridge, except perhaps under strict supervision. Surface runoff from the road is likely to contain contaminants and the EPA recommended that consideration be given to incorporating sump facilities, oil interceptors, and sediment traps into the design of the LFC. This recommendation was not adopted in view of the low frequency of serious spills and the established practice in Hong Kong of draining roads into the sea.

Extension of the Tung Wan embayment

The bridge support structures in the Tsing Ma and Kap Shui Mun Channels are likely to have local impacts particularly in Tung Wan Bay.

Extension of the Tung Wan embayment out into the channel will be required and this could further reduce the flushing capacity of the bay where exchange of water between the channel and the bay is already slow. It was concluded that there could be a reduction in water quality but it was not anticipated that the WQOs will be breached. This was given further consideration in the subsequent more detailed assessment and it was concluded that the changes in water movements could be beneficial (see Chapter 3 of this report).

Mitigation of Impacts

The EPA identified that the main impacts will be from excavation and dredging and are likely to be in the form of increased suspended solids and turbidity. This could be considered a nuisance at Tung Wan Beach and significant at the Kung Tsai Wan fish culture zone with loss of livestock in extreme cases. The risks to these environmentally sensitive receivers is not considered great but the following options are still recommended for minimising the impacts:

- (a) Silt curtains could be used to prevent the migration of suspended particulates from one area to another and could be used to protect Tung Wan Beach during the bathing season.
- (b) Silt curtains would also protect the Kung Tsai Wan fish culture zone. If dissolved oxygen levels drop rapidly a supply of oxygen to the cages may be necessary and less expensive than compensating for loss of stock.
- (c) Sediment traps could be used to prevent run off water laden with sediment entering adjacent water bodies during land based excavation of the western anchorage for the Tsing Ma Bridge.
- (d) Appropriate scheduling of excavation and dredging activities could minimise impacts for example by avoiding the busy bathing season at Tung Wan Beach.
- (e) Appropriate dredging techniques could minimise turbidity generation.
- (f) Scheduling of blasting activities should consider the sensitive receivers.

At the work sites pollution should be minimised by adequate drainage and sewage treatment facilities. The latter should be connected to existing foul sewers wherever possible. Discharge consents will need to be obtained from EPD once the area is declared a Water Control Zone. Drainage facilities should incorporate oil and sediment traps to prevent the discharge of pollutants to the receiving water body.

Any liquid used to reduce dust levels of stockpiled materials on and off site should be kept to a minimum and not discharged directly to adjacent water bodies. Chemicals used near crops or potable water sources should also be contained.

Accidental discharges from work sites and washout water from batching plants will be of concern during construction. Usually these will be collected using surface drainage collectors, grit traps, and oil interceptors. Silt curtains will protect sensitive receivers from silt laden waters. Any oil based discharges should be quickly contained using floating booms. In any case strict control of discharges at work sites will be required to avoid local pollution.

There is a risk of spillages from vehicles crossing the bridges during operation and a spill action plan may be necessary. Oil based spills should be contained with a containment boom and collected from the surface or broken down.

A spill action plan is required for construction and operation of the LFC to minimise potential impacts on water quality.

These mitigation methods have been taken into consideration in developing the contract conditions. The conditions have specified that water quality impacts will not be permissible and monitoring will be carried out throughout construction to identify any impacts. If these show that water quality is deteriorating the contractor will have to implement mitigation measures as appropriate.

1.2.5 Noise Pollution

Construction Phase Impacts

Noise impacts during construction are likely to result from a number of construction activities either working alone or in combination with others. The impacts of these will be influenced by the duration of the activities, sound power levels of items of mechanical equipment, their locations, time of day and the prevailing background noise. The main sources of noise will be from stationary activities such as excavation and vehicle movements on haul roads.

The method of calculating the impacts from powered mechanical equipment followed the procedure described in the Technical Memorandum on Noise from Construction Work Other Than Percussive Piling. The noise parameter calculated for the EPA was $L_{eq(30 \text{ min})}$. The potential noise levels from haul roads was calculated following the procedure in BS 5228. The noise parameter calculated was $L_{eq(1-hr)}$. Noise impacts were then assessed against the Acceptable Noise Levels (ANLs) from the NCO.

Current legislation does not specify limits for noise from construction activities from 0700 to 1900 hours (non-restricted hours) hence the normal practice adopted for the contract documents to include noise constraints setting a limit of 10 dB(A) above the ambient background. However this was not adopted for these contracts as this could constrain construction and lead to late completion. Between 1900 and 0700 hours and at any time on a general holiday general construction work using powered mechanical equipment is prohibited unless covered by a Construction Noise Permit.

Only a few activities were expected to be in progress at the same time at night time and so night time noise levels were taken as being similar to those predicted for the single activity scenario in the daytime.

The assessment predicted that major noise impacts will arise in almost all areas. The duration and timing of the exceedance of the noise limit criteria will depend on the detailed construction programme. The construction noise has subsequently been considered in more detail and this is discussed in Chapter 4 of this report.

Operational Phase Impacts

Road Traffic Noise

Traffic noise levels were calculated in $L_{10(1-hr)}$ using the UK Department of Transport procedure "Calculation of Road Traffic Noise".

The recommended maximum traffic noise levels at the external facade in the HKPSG is 70 dB(A) for new dwellings and 65 dB(A) for new schools. The guideline for hospitals varies from 50 to 60 dB(A) depending on the use.

The assessment showed that the noise levels defined in the HKPSG will not be exceeded at the NSRs. This is due to the distance of the NSRs from the road and also partly due to the screening from the bridge decks as the traffic will be above the receivers.

Train Noise

The recommended standard in the HKPSG for rail noise is 65 dB(A) $L_{eq(24-hr)}$ at the external facade of any receiver. The HKPSG states that this guideline is currently under review and the revised guideline will probably require that the L_{max} should not exceed 85 dB(A) from 2300 to 0700 hours.

Impacts from rail noise were assessed in terms of L_{max} and $L_{eq(24-hr)}$, following the methods described in the "Transportation Noise Reference Book" and the UK Noise Advisory Council's publication "A Guide to the Measurement and Prediction of the Equivalent Continuous Sound Level L_{eq} ".

Assessment of the impacts due to rail noise was complicated by a lack of information on the rolling stock requirements and detailed engineering design. Data on the effects of the passage of trains across steel bridge structures was limited and impacts could not be precisely determined as much of the noise emitted will depend on the amount of vibration transmitted to the bridge and viaduct structures during a train passage and the inherent damping of the bridge and viaduct structure. The conditions of the rail and wheel will also have a significant effect on the noise radiated from the structure.

The peak noise level generated by trains passing over the Tsing Ma Bridge was predicted to be amplified by 10 dB(A) based on noise measurements from other structures. In predicting the train noise a peak noise level of 83 dB(A) at 25 m from the track has been used. This was based on measurements using a four car unit of the BREL Class 321 EMU type operating at 160 km/hr. This is typical of the type of train that could be used on the airport railway.

Preliminary calculations indicated that $L_{eq(24-hr)}$ levels in excess of the current HKPSG standards of 65 dB(A) could arise within 250 m of the Ma Wan Viaduct. This would include a significant number of properties on Ma Wan. In other areas noise levels were not predicted to exceed the criteria although they could be close to the limits at San Po Tsui and Tai Chuen.

Mitigation of Impacts

During the construction phase noise levels should be minimised by undertaking the following general measures:

- (a) noisy equipment and activities should be sited as far as possible away from noise sensitive receivers;
- (b) all equipment should be maintained in good condition with noise levels reduced by silencers, mufflers, acoustic linings, enclosures, and screens;
- (c) the potential for disturbance at nearby NSRs should be considered when planning work areas, positioning equipment, and scheduling operations;
- (d) where possible percussive piling should be replaced by non percussive techniques;

- (e) the use of rock drills should be minimised; and
- (f) haul road traffic should be minimized at night time.

A more detailed assessment of construction noise has been carried out and is reported in Chapter 4 of this report. An exemption to the NCO has been granted so that the contractor will be able to work in the restricted periods. This exemption is subject to a number of conditions that are discussed in Chapter 4.

The preliminary assessment of the operational phase has predicted that dwellings within 250 m of the Kap Shui Mun Bridge and Ma Wan Viaducts will be adversely impacted by noise levels in excess of the HKPSG. It is important that careful consideration is given to the design of the bridges and viaducts since previous experience suggests that there is little scope for mitigation once lightweight steel elevated structures become operational. The EPA recommended that options to be considered should include the following:

- (a) damping treatment with the application of a layer of viscoelastic material to the steel plates of the structure will help to reduce the amplitude of vibration;
- (b) vibrational isolation can be achieved with the use of resilient rail fasteners, resilient supported ties, ballast and floating slabs;
- (c) acoustic absorption using internal absorptive material on the Ma Wan Viaduct will help to reduce the transmission of train noise to the structure;
- (d) reduction of the radiating area can be achieved by minimising large plate girders, using a narrow deck or by building two physically isolated structures instead of one double track structure;
- (e) increasing the mass of the structure will reduce the vibration amplitude;
- (f) treatment of bogie assembly by reducing the stiffness of primary suspension which supports the bogie on the axles and increasing the structural damping of the bogie assembly will serve to reduce the wheel-rail interaction and hence the amplitude of rail vibration; and
- (f) minimisation of wheel and rail surface irregularities by truing and rail grinding will reduce wheel-rail interaction and associated vibration.

The most significant impact from the project will be train noise and although mitigation will reduce the noise levels it may still not comply with the HKPSG noise levels.

The EPA concluded that a detailed noise and vibration analysis should be conducted to demonstrate that trains can be operated at 150 km/hr and at the frequency specified by the Airport Railway Link Study on the suspension bridges and the Ma Wan Viaducts without causing excessive noise to noise sensitive receivers on Ma Wan and North Lantau.

The design of the Tsing Ma Bridge was reviewed following the environmental assessment and measures to reduce the noise have been incorporated. Measures have also been incorporated into the tender documents for the Kap Shui Mun Bridge and the Ma Wan Viaducts to minimise noise. These are discussed in further detail in Chapter 5 of this report.

1.2.6 Visual Impacts

It is considered that much of the area is highly sensitive to modifications in the landscape. North Lantau is relatively undeveloped and comprises hilltops and ridgelines with exposed steep slopes and a sea/land coastal interface. Ma Wan has a relatively low profile characterised by dense woodland and vegetation. Its visual significance diminishes with distance.

Visual impacts will include steep and extensive cut slopes, major bridge structures and foundations, viaducts, associated works and temporary works areas, and roadways and road surfaces.

Mitigation of Impacts

Temporary screening of works areas adjacent to residential areas should be considered for the construction phase.

Slopes could be designed to merge into their surroundings and should be planted with indigenous species which are ecologically appropriate and require minimum maintenance. Planting will also provide screening and diversity for the road users. Existing vegetation should be protected and maintained wherever possible.

Roadway structures, buildings and auxiliary features should be unobtrusive and screened wherever possible.

Good design of the bridges and viaducts is important and it was recommended that the detailed proposals are reviewed by ABACAS.

1.2.7 Land Use Impacts

The majority of the land required for the LFC on Ma Wan and North Lantau is located within Crown Land. However several footpaths will be severed.

On north Lantau the pier at Tai Chuen will be resumed and properties at Tai Chuen and Ng Kwe will be affected, with the latter becoming severed from the rest of Lantau.

On Ma Wan two graveyards, a beach at Sha Lau Tong Wan, a Sea Activity Centre, a Site of Special Archaeological Interest and several short term tenancy areas will be affected by the LFC. The beaches at Sha Lau Tong Wan and Tung Wan will be affected by pier construction.

Mitigation of Impacts

The potential for recreational utilisation should be considered as an after use for lands severed or isolated by the project.

Issues relating to land ownership and grave/Fung Shui areas should be dealt with through the District Lands Office. Lead times required to shift graves etc should be taken into account.

The potential for noise and air pollution due to the LFC should be incorporated into any future development plans for the area.

To avoid creating completely artificial coastlines road alignments could be slightly adjusted. Wherever possible pedestrian access to coastal areas should be maintained.

1.2.8 Recommendations in the EPA

By defining target limits and sensitive receivers the EPA has defined how the quality of the environment should be maintained. However compliance with these target limits can only be determined through regular monitoring to avoid deterioration in environmental quality. Initially baseline monitoring will be required to establish the ambient levels before any impacts occur and an action plan will be required in case of non-compliance with target levels, together with mitigation. An Environmental Audit will then be required after completion of the project to ensure that the LFC operates within the predefined environmental limits. This should be followed up with periodic post-development auditing to monitor compliance with objectives and legislative requirements and therefore assess the environmental impact of the project.

2. Air Quality

2. AIR QUALITY

2.1 Introduction

The EPA predicted significant impacts from dust during construction but concluded that air quality impacts during operation would be acceptable. However neither construction or operation stage assessments included the combined impacts from Route 3 as details were not then available. In addition the preliminary assumptions of construction methods which were made for the LFC may be refined now as more details of the construction methods are known.

The operation stage assessment of the LFC in the EPA used estimated traffic figures which have now been updated as a result of work for the North Lantau Development.

The objective of this study therefore has been to review the previous construction assessment using the latest data on construction methods and the results of the Route 3 studies. The operation stage assessment has been reviewed taking the latest traffic data into account and taking the Route 3 operation stage assessment into account. The Route 3 studies have been reported on in Route 3 Technical Report No. 19 "Environmental Impact Assessment".

The Study Area for the construction assessment covers about 17 km² and is shown on Figure 2.1. The earlier assessment did not include the section of road works on North Lantau between the Kap Shui Mun Bridge and the North Lantau Expressway at Yam O (the North Lantau Road) as details of its construction, including the timing were not known. However concerns have been expressed over the impact from dust during the construction of the North Lantau Road (NLR) on the operation of the dockyards north of Tsing Chau Tsai. This section of road has therefore now been included in the assessment. However the timing of its construction, in relation to the remainder of the LFC, is still uncertain so the impacts from the North Lantau Road have been assessed both separately and in combination with impacts from the remainder of the project.

2.2 Background Levels

Background levels of air pollution (Table 2.1) were developed for the EPA and these have now been reviewed taking account of recent survey data at Tung Chung collected by the North Lantau Development Consultants during the period of 14/1/91 to 22/1/91, (Table 2.2). The background levels used in the EPA were derived from the mean results of air quality monitoring carried out at two sites on East Tsing Yi during 1988. The air pollutants monitored in Tung Chung were relatively low when compared with the levels in East Tsing Yi, but this is expected as the Tsing Yi stations are much closer to the more polluted urban areas. The survey data therefore confirm the validity of the background data used for the EPA as East Tsing Yi is closer to the Study Area. The background data used for the present assessment are therefore the maximum 1-hour, 8-hour and 24-hour figures collected at East Tsing Yi.

Table 2.1 Background Levels of Air Pollution at East Tsing Yi

Pollutant	Concentration in $\mu\text{g}/\text{m}^3$ (ppm in bracket)			
	Mean	Max 1-Hour	Max 8-Hour	Max 24-Hour
NO	30 (0.024)	268 (0.22)		92 (0.075)
NO ₂	35 (0.018)	129 (0.069)		63 (0.033)
CO	655 (0.572)	1805 (1.6)	1330 (1.2)	940 (0.82)
O ₃	21 (0.011)	126 (0.064)		59 (0.03)
TSP	121			177
RSP	44			70

Table 2.2 Air Quality Data Collected at Tung Chung

Pollutant	Concentration in $\mu\text{g}/\text{m}^3$ (ppm in bracket)	
	Mean	Max 24-Hour
NO	11 (0.009)	31 (0.025)
NO ₂	24 (0.012)	40 (0.021)
CO	282 (0.25)	418 (0.36)
TSP	50	72

2.3 Air Sensitive Receivers

Air Sensitive Receivers (ASRs) were identified in the EPA in accordance with the Hong Kong Planning Standards and Guidelines (HKPSG). The sensitive receivers are listed below and are illustrated in Figure 2.1.

1. Tung Wan Bay (TWB)
2. Tin Liu (TL)
3. Football Ground (Ma Wan) (FG)
4. Ma Wan Town (MWV)
5. Lau Fa Village (LF)

6. San Po Tsui (SPT)
7. Yi Chuen (YC)
8. Tso Wan (TW)
9. Sha Lau Tong Wan (SLT)
10. Dockyard 1 (Tsing Chau Wan) (DY1)
11. Dockyard 2 (Tsing Chau Wan) (DY2)
12. Dockyard 3 (Tsing Chau Wan) (DY3)

The dockyards at Tsing Chau Wan have been added to the list of sensitive receivers previously identified for the EPA. These receivers were not considered to be sensitive uses under the definitions in the HKPSG but it is understood that the dockyard operators consider that their activities, which include painting of ships, could be affected by dust from the LFC construction works.

Additional ASRs are located along Castle Peak Road in the general area of Tin Kau and Sham Tseng. However the impact of the LFC on these will be small and they have therefore not been identified separately for the computer modelling.

The ASRs were located for the modelling according to the Hong Kong Metric Grid. In addition, 200 grid points were distributed evenly within the Study Area to allow pollutant contours to be drawn.

2.4 Meteorological Data

Worst case meteorological conditions for air dispersion have been chosen for the air quality assessment as follows : -

Wind Speed	: 2ms ⁻¹
Wind Direction:	0° to 348.75° with 11.25° interval in ISCST worst case option in CALINE 4
Stability Class:	D
Temperature	: 25°C
Mixing height	: 1000m

2.5 Methodology for the Construction Phase Assessment

Dusts are subdivided into two categories with nominal aerodynamic diameter 0-10 μm and 10-30 μm . The dust particles larger than 30 μm tend to settle relatively fast in the near vicinity of the source. The dust with aerodynamic diameter 0-10 μm are defined as RSP and TSP is the total of the two categories.

2.5.1 Modelling Techniques

The Industrial Source Complex Short Term Model (ISCST) has been used to quantify air quality impacts during the construction phase. The extent of the changes in air quality has then been examined, and exceedance of the Hong Kong Air Quality Objectives (AQO) determined. Table 2.3 summarises the Hong Kong AQO.

Table 2.3 Air Quality Objectives

Concentration in micrograms per cubic metre (i) (Parts per million (ppm) in brackets)					
Pollutant	1 Hour (ii)	8 Hour (iii)	24 hours (iii)	3 Months (iv)	1 Year (iv)
Sulphur Dioxide	800 (0.30)		350 (0.13)		80 (0.03)
Total Suspended Particulates	(vii)		260		80
Respirable Suspended Particulates (v)			180		55
Carbon Monoxide	30,000 (26.20)	10,000 (8.73)			
Nitrogen Dioxide	300 (0.16)		150 (0.08)		80 (0.04)
Photochemical Oxidants (as ozone) (vi)	240				
Lead				1.5	

- Notes:**
- (i) Measured at 298K (25°C) and 101.325 kPa (one atmosphere).
 - (ii) Not to be exceeded more than three times per year.
 - (iii) Not to be exceeded more than once per year.
 - (iv) Yearly and three monthly figures calculated as arithmetic means.
 - (v) Respirable suspended particulates means suspended particles in air with nominal aerodynamic diameter of 10 micrometres and smaller.
 - (vi) Photochemical oxidants are determined by measurement of ozone only.
 - (vii) Suggested short term averaging level for 1 hour is 500 $\mu\text{g}/\text{m}^3$.

2.5.2 Wind Conditions

Results generated for 32 wind directions have been compared and the highest value has been chosen for each receptor point to estimate the worst case. However, it is unlikely that the wind will blow from the same angle for 24 hours. The 24 hour average dust levels have therefore been calculated by summing up dust levels at each of the 32 wind directions multiplied by the percentage frequency of that wind direction based on wind data provided by the Royal Observatory measured at Hong Kong United Dockyards on Tsing Yi in 1989.

2.5.3 Emission Factors

The assessment of Route 3, the Tsing Ma Bridge and the Kap Shui Mun Bridge/Ma Wan Viaducts has focused on the four key activities of blasting, drilling, concrete batching and traffic on unpaved haul roads. The construction activities on the North Lantau Road which are likely to have dust impacts on the ASRs are:-

- 1) blasting;
- 2) drilling;
- 3) traffic on unpaved haul roads;
- 4) rock crushing assumed to be on the reclamation at Tai Ching Chau;
- 5) concrete batching; and
- 6) loading and unloading of excavated material.

Where the exact locations for these activities are unknown at this stage, a reasonable worst-case scenario of the activities has been assumed. Emission factors for each activity have been estimated using USEPA AP-42 4th Edition, 1985. Details of emission factors for each construction activity are detailed in Appendix A.

The calculations have firstly been carried out assuming no dust mitigation methods are applied. Mitigation measures to reduce impacts have then been assessed.

2.5.4 Construction Activities for the LFC

Locations of Construction Activities

The construction activities identified as key issues are illustrated in Figures 2.2 to 2.5 and their locations in HK Metric Grid coordinates are shown in Appendix A. In some cases the detailed locations of activities are uncertain and the centre of work site has been assumed to be the point of emission. Dust emitted from vehicles passing over unpaved haul roads have been estimated as line sources in a series of 7m squares.

Construction Programme

Three periods during the construction phase of the LFC have been identified as having the largest effects on the ASRs. The periods singled out are based on the extent of construction works being carried out and the distances between the ASRs and the construction activities. These are referred to as Periods 1, 2 and 3. Period 1 will last for the first six months of the contract. Period 2 will be the next twelve months while the remaining construction programme will then be included in Period 3.

The construction programme of the North Lantau Road is not yet well defined at this stage. It has been assumed firstly that the construction of the North Lantau Road will be carried out separately from the remainder of the LFC, secondly at the same time as Period 2 and thirdly at the same time as Period 3.

Emission Quantities

Construction activities for the Tsing Ma Bridge have been reviewed based on the latest design details available. No further design has been carried out on the Kap Shui Mun Bridge or Ma Wan viaducts and construction activities have been assumed to be the same as those used for the EPA. The emissions from the key construction activities are shown in Appendix A.

2.5.5 Construction Activities for Route 3

Detailed emission data have been requested from the Route 3 Consultants and it was intended that these should be incorporated into the modelling to obtain a combined assessment. However, these raw data have not been available and the assessment has made use of construction methods and assessment results presented in Route 3 Technical Report No. 19.

Blasting on both Ting Tau Northern Section and Tsing Yi Section and traffic from unpaved haul roads on Tsing Yi have been identified as the major sources of dust from Route 3 construction. These construction activities will last from February 1992 to June 1994 which will coincide with Periods 1, 2 and 3 of the construction of the Lantau Fixed Crossing. Combined impacts from blasting and haul roads on Route 3 and all LFC construction works have been assessed for these periods.

2.5.6 Works Areas

The computer modelling has included emissions from the works areas connected with the LFC except at Penny's Bay.

The works site at Penny's Bay may be formed for use as a steelwork fabrication yard. However it is remote from air sensitive receivers and is not likely to cause dust nuisance during its construction or later use. The works site will be formed by reclamation and much of the work will be carried out in the wet which will limit the dust emission. It has therefore been concluded that the air quality impacts of the Penny's Bay works site will be minimal.

2.6 Assessment of Construction of the LFC excluding the North Lantau Road

2.6.1 Predicted Dust Levels

The maximum predicted dust levels at each ASR for the LFC excluding the North Lantau Road without mitigation are given in Tables 2.4 and 2.5.

One objective of the assessment of impacts has been to measure the predicted air quality against the air quality objectives. The concentration of pollutants will include background levels and the contribution from the construction works. No attempt has been made to extrapolate the combined data to 1-hour levels due to the difficulty of estimating 1-hour background levels.

The estimated TSP and RSP levels for each ASR during construction Periods 1, 2 & 3 are given in Appendix B and are illustrated in Figures 2.6 to 2.11. All these assume that no mitigation measures are applied. Figures 2.12 to 2.17 show the combined 24-hour average impacts from all LFC works (excluding the North Lantau Road) and blasting and haul roads on Route 3.

Table 2.4 Maximum Predicted TSP Levels (without mitigation) ($\mu\text{g}/\text{m}^3$)

Sensitive Receiver	Period 1						Period 2						Period 3					
	LFC (a)(c)		Route 3 (a)		Combined Impact		LFC (a)(c)		Route 3 (a)		Combined Impact		LFC (a)(c)		Route 3 (a)		Combined Impact	
	1hr	24hr	1 hr	24 hr	24 hr (a)	24 hr (b)	1hr	24hr	1hr	24hr	24hr (a)	24hr (b)	1hr	24hr	1hr	24hr	24hr (a)	24hr (b)
1. TWB	4550	1020	1000	20	1040	1217	650	70	1000	20	90	267	650	80	1000	20	100	277
2. TL	2560	620	920	20	640	817	220	30	920	20	50	227	370	30	920	20	50	227
3. FG	2910	1050	740	20	1070	1247	220	30	740	20	50	227	370	40	740	20	60	237
4. MWV	4590	1660	850	10	1670	1847	260	40	850	10	50	227	230	40	850	10	50	227
5. LF	13550	6220	910	10	6230	6407	300	40	910	10	50	227	300	40	910	10	50	227
6. SPT	5130	510	740	7	520	694	90	3	740	7	10	187	160	5	740	7	10	192
7. YC	5580	400	720	7	410	584	120	1	720	7	8	185	250	3	720	7	10	190
8. TW	1550	100	640	6	110	283	70	1	640	6	7	184	210	2	640	6	8	183
9. SLT	6490	1480	980	10	1490	1667	1910	310	980	10	320	497	1900	310	980	10	320	497
10.DY1	680	10	480	4	14	191	20	0	480	4	4	181	100	1	480	4	5	182

- Notes : (a) Excludes background levels
 (b) Includes a background of $177 \mu\text{g}/\text{m}^3$
 (c) LFC excludes North Lantau Road

Table 2.5 Maximum Predicted RSP levels (without mitigation) ($\mu\text{g}/\text{m}^3$)

Sensitive Receiver	Period 1						Period 2						Period 3					
	LFC (a)(c)		Route 3 (a)		Combined Impact		LFC (a)(c)		Route 3 (a)		Combined Impact		LFC (a)(i)		Route 3 (a)		Combined Impact	
	1hr	24hr	1hr	24hr	24hr (a)	24hr (b)	1hr	24hr	1hr	24hr	24hr (a)	24hr (b)	1hr	24hr	1hr	24hr	24hr (a)	24hr (b)
1. TWB	2290	480	560	10	490	560	290	30	560	10	40	110	290	40	570	10	50	120
2. TL	1230	300	510	10	310	380	120	10	510	10	20	90	160	20	510	10	30	100
3. FG	1240	510	450	10	520	590	90	20	450	10	30	100	150	20	450	10	30	100
4. MWV	2220	810	490	8	820	888	80	20	490	8	28	98	90	20	490	8	28	98
5. LF	6660	2900	520	6	2910	2976	110	20	520	6	26	96	130	20	520	6	26	96
6. SPT	1660	340	430	4	340	414	40	1	430	4	5	75	80	2	430	4	6	76
7. YC	1710	160	420	4	160	234	50	1	420	4	5	75	110	1	420	4	5	75
8. TW	760	40	370	4	40	114	30	0	370	4	4	74	90	1	370	4	5	75
9. SLT	3280	740	540	8	750	818	780	140	540	8	148	218	780	140	340	8	148	218
10.DY1	320	7	300	2	9	79	7	0	300	2	2	72	50	1	300	2	3	73

- Notes: (a) Excludes background levels
 (b) Includes a background level of $70\mu\text{g}/\text{m}^3$
 (c) LFC excludes North Lantau Road

The following conclusions (assuming at this stage no mitigation measures) have been made from the assessment.

- (a) Period 1 of the LFC construction will cause the greatest impacts. The highest hourly TSP and RSP levels are estimated to be 13550 and 6660 $\mu\text{g}/\text{m}^3$ (no dust mitigation) respectively and only two out of ten ASRs in the Study Area are within the 24 hour AQO. They are Tso Wan and the Dockyards in Tsing Chau Wan but these may also be affected by the road construction in North Lantau. It was assumed that construction activities for the Kap Shui Mun Bridge will be carried out simultaneously with the construction of Ma Wan pier of the Tsing Ma Bridge and this may give a conservative result.
- (b) There will be significant impacts on all the ASRs during Periods 2 and 3, and the recommended 1 hour TSP level will probably be exceeded at all ASRs. The biggest contributor to the 1-hour predictions will be Route 3. A summary of the percentage exceedance of 24-hour AQO during construction is illustrated in Table 2.6. 24-hour TSP dust levels predicted during Period 2 and Period 3 at Tung Wan Bay will marginally exceed the AQO.
- (c) The main impact will be from drilling and blasting and traffic on haul roads which have been assumed to be unpaved.
- (d) Dust levels predicted are lower than those predicted in the EPA with the exception of Tung Wan Bay. The differences are due to the following:-
 - (i) the present assessment has divided the work into three periods; and
 - (ii) the detail of construction activities has changed.

Table 2.6 Summary of the Percentage Exceedance of 24-Hour AQO during Construction (Without Mitigation)

Sensitive Receiver	Period 1		Period 2		Period 3	
	TSP	RSP	TSP	RSP	TSP	RSP
1. TWB	368	211	3	-39	7	-33
2. TL	214	111	-13	-50	-13	-44
3. FG	379	228	-13	-44	-9	-44
4. MWV	610	393	-13	-46	-13	-46
5. LF	2364	1553	-13	-47	-13	-47
6. SPT	167	130	-28	-58	-26	-58
7. YC	125	30	-29	-58	-27	-58
8. TW	9	- 37	-29	-59	-30	-58
9. SLT	541	354	91	21	91	-45
10. DY1	- 27	- 56	-30	-60	-30	-59

2.6.2 Mitigation Measures

A detailed discussion of possible mitigation measures was carried out for the EPA and is included here as Appendix C.

Dust emissions may be reduced substantially with the combination of the control methods and even the highest level of TSP (due to haul road traffic) estimated at Lau Fa could be reduced to about $650 \mu\text{g}/\text{m}^3$ for a 1 hour average and for 24 hour average this will be about $260 \mu\text{g}/\text{m}^3$.

The largest contributor to dust nuisance in Periods 2 and 3 will be Route 3 and strict mitigations measures should be included in Route 3 construction contracts. The discussion in Appendix C may be used as a guide to mitigation measures.

Occasional nuisance arising from dust will occur at all ASRs due to blasting operations. However, it should be noted that the key dust construction activities will be of limited duration of approximately half a year and the population affected is relatively small.

The application of strict mitigation measures to both Route 3 and LFC contracts will allow the works to proceed with little or no exceedance of 24-hour AQOs. The suggested 1-hour AQO of $500 \mu\text{g}/\text{m}^3$ will be exceeded on occasions during the early works for the LFC.

2.7 Assessment of Construction of the LFC including the North Lantau Road

2.7.1 Introduction

In assessing combined impacts from the whole of the LFC and Route 3, it has been assumed that the North Lantau Road would not be constructed at the same time as Period 1 of the remainder of the project. This assumption has been made because:-

- (a) The construction period for the North Lantau Road will be shorter and it is therefore likely to start later than the remainder of the LFC to meet the same opening date; and
- (b) Period 1 is only 6 months long and is thus less likely to coincide with the main dust producing activities on the North Lantau Road.

The dust levels have firstly been assessed assuming that no mitigation is applied and secondly assuming the following mitigation methods:-

- (a) concrete batching
 - enclosure of dumping and loading areas; enclosure of conveyors and elevators; filters on storage bin vents and use of water
- (b) rock crushing
 - cyclone, fabric filters and wet spray system
- (c) haul road
 - watering, surface chemical treatment, and vehicle speed control
- (d) loading and unloading
 - watering, and chemical wetting agents

The results of the assessment are shown on Tables 2.7 to 2.18.

2.7.2 1 Hour Dust Levels

Dust from the North Lantau Road construction without mitigation will have significant impacts on all ASRs on Ma Wan and North Lantau which will in nearly all cases exceed the EPD recommended 1 hour TSP level of $500 \mu\text{g}/\text{m}^3$ (Tables 2.7 and 2.10).

The three main construction activities affecting the ASRs will be hauling, rock crushing and blasting. Rigorous dust emission control for haul roads and rock crushing could reduce the dust level by some 70 percent for these activities (Tables 2.9 and 2.12). However, ASRs on North Lantau will still receive high 1-hour dust levels from blasting which cannot easily be mitigated.

Dust from the Route 3 and the remainder of the LFC could increase the 1-hour dust level at ASRs on North Lantau, although, when compared to the total dust emissions from the North Lantau Road the dust levels from other parts of the construction will be relatively small (Tables 2.8 and 2.11). Figures 2.18 to 2.21 illustrate the TSP and RSP distribution without and with dust mitigation.

Table 2.7 Highest 1-hr TSP ($\mu\text{g}/\text{m}^3$) Concentration for the North Lantau Road - Background Level Excluded (Without Mitigation)

Sensitive Receiver	Concrete Batching Only	Blasting and Drilling	Rock Crushing Only	Loading and Unloading	Haul Road Only	All Activities
1. TWB	1	220	10	3	280	520
2. TL	3	170	50	7	180	350
3. FG	3	340	50	9	230	630
4. MWV	2	460	30	8	340	840
5. LF	3	200	50	7	360	460
6. SPT	3	1060	50	20	610	1740
7. YC	3	350	60	10	660	830
8. TW	5	920	90	10	200	1090
9. SLT	2	340	40	8	420	810
10. DY1	30	1580	490	30	330	1770
11. DY2	30	1270	280	50	460	1500
12. DY3	20	510	280	30	480	1320

Table 2.8 Combined 1-hr TSP ($\mu\text{g}/\text{m}^3$) Concentration - Background Level Included (Without Mitigation)

Sensitive Receiver	North Lantau Road	Tsing Ma Bridge Ma Wan Viaducts Kap Shui Mun Bridge	Route 3	Combined
1. TWB	520	650	1000	1120
2. TL	350	370	920	1300
3. FG	630	370	790	1120
4. MWV	840	240	850	920
5. LF	460	330	910	1200
6. SPT	1740	160	740	1740
7. YC	830	250	720	960
8. TW	1090	210	620	1090
9. SLT	810	1910	980	1980
10. DY1	1770	120	280	1770
11. DY2	1500	70	370	1500
12. DY3	1320	60	410	1320

Table 2.9 Combined 1-hr TSP ($\mu\text{g}/\text{m}^3$) Concentration - Background Level Included (With Mitigation)

Sensitive Receiver	North Lantau Road	Tsing Ma Bridge Ma Wan Viaducts Kap Shui Mun Bridge	Route 3	Combined
1. TWB	310	650	1000	1120
2. TL	220	<u>370</u>	920	1300
3. FG	420	370	790	1120
4. MWV	570	<u>240</u>	850	920
5. LF	270	330	910	1200
6. SPT	1250	160	740	1260
7. YC	440	250	720	960
8. TW	1000	210	620	970
9. SLT	480	<u>1910</u>	980	1980
10. DY1	1640	120	280	1640
11. DY2	1340	70	370	1340
12. DY3	750	60	410	750

Table 2.10 Highest 1-hr RSP ($\mu\text{g}/\text{m}^3$) Concentration for the North Lantau Road - Background Level Excluded (Without Mitigation)

Sensitive Receiver	Blasting and Drilling	Rock Crushing Only	Loading and Unloading	Haul Road Only	All Activities
1. TWB	60	1	2	150	220
2. TL	50	4	5	100	120
3. FG	90	4	6	130	230
4. MWV	120	3	5	180	320
5. LF	60	4	5	190	220
6. SPT	270	4	10	330	610
7. YC	90	5	7	350	370
8. TW	240	8	7	110	330
9. SLT	90	4	5	230	330
10. DY1	400	40	20	170	500
11. DY2	320	40	30	240	440
12. DY3	130	20	20	250	430

Table 2.11 Combined 1-hr RSP ($\mu\text{g}/\text{m}^3$) Concentration - Background Level Included (Without Mitigation)

Sensitive Receiver	North Lantau Road	Tsing Ma Bridge Ma Wan Viaducts Kap Shui Mun Bridge	Route 3	Combined
1. TWB	220	290	560	600
2. TL	120	160	510	680
3. FG	230	150	450	560
4. MWV	320	90	490	520
5. LF	220	130	520	650
6. SPT	610	80	430	610
7. YC	370	110	420	530
8. TW	330	90	370	470
9. SLT	330	780	540	1010
10. DY1	500	50	170	500
11. DY2	440	30	230	440
12. DY3	430	40	260	430

Table 2.12 Combined 1-hr RSP ($\mu\text{g}/\text{m}^3$) Concentration - Background Level Included (With Mitigation)

Sensitive Receiver	North Lantau Road	Tsing Ma Bridge Ma Wan Viaducts Kap Shui Mun Bridge	Route 3	Combined
1. TWB	110	290	560	600
2. TL	70	160	510	680
3. FG	130	150	450	560
4. MWV	180	90	490	520
5. LF	90	130	520	650
6. SPT	370	80	430	510
7. YC	150	110	420	530
8. TW	260	90	370	460
9. SLT	170	780	540	1010
10. DY1	430	50	170	430
11. DY2	360	30	230	360
12. DY3	220	40	260	290

Table 2.13 24-hr Averaged TSP ($\mu\text{g}/\text{m}^3$) Concentration for the North Lantau Road - Background Level Excluded (Without Mitigation)

Sensitive Receiver	Concrete Batching Only	Blasting and Drilling	Rock Crushing Only	Loading and Unloading	Haul Road Only	All Activities
1. TWB	0	2	0	0	3	6
2. TL	0	2	0	0	7	10
3. FG	0	3	0	0	8	10
4. MWV	0	4	0	0	8	10
5. LF	0	2	0	0	5	7
6. SPT	0	10	0	0	90	100
7. YC	0	3	0	0	10	20
8. TW	0	6	0	0	30	40
9. SLT	0	1	0	0	2	4
10. DY1	1	130	20	3	120	280
11. DY2	3	130	50	6	100	290
12. DY3	1	30	20	2	30	80

Table 2.14 Combined 24-hr Averaged TSP ($\mu\text{g}/\text{m}^3$) Concentration - Background Level Excluded (Without Mitigation)

Sensitive Receiver	North Lantau Road	Tsing Ma Bridge Ma Wan Viaducts Kap Shui Mun Bridge	Route 3	Combined
1. TWB	6	80	20	100
2. TL	10	30	20	60
3. FG	10	40	20	70
4. MWV	10	40	10	70
5. LF	7	40	10	60
6. SPT	100	5	7	110
7. YC	20	3	7	30
8. TW	40	2	6	40
9. SLT	4	310	14	330
10. DY1	280	3	6	280
11. DY2	290	1	4	290
12. DY3	80	1	4	90

Table 2.15 Combined 24-hr Averaged TSP ($\mu\text{g}/\text{m}^3$) Concentration - Background Level Excluded (With Mitigation)

Sensitive Receiver	North Lantau Road	Tsing Ma Bridge Ma Wan Viaducts Kap Shui Mun Bridge	Route 3	Combined
1. TWB	3	80	20	100
2. TL	4	<u>30</u>	20	60
3. FG	6	40	20	60
4. MWV	7	<u>40</u>	10	60
5. LF	3	40	10	60
6. SPT	40	5	7	50
7. YC	7	<u>3</u>	7	20
8. TW	10	2	6	20
9. SLT	2	310	14	320
10. DY1	170	3	6	180
11. DY2	170	1	4	180
12. DY3	50	1	4	50

Table 2.16 24-hr Averaged RSP ($\mu\text{g}/\text{m}^3$) Concentration for the North Lantau Road - Background Level Excluded (Without Mitigation)

Sensitive Receiver	Blasting and Drilling	Rock Crushing Only	Loading and Unloading	Haul Road Only	All Activities
1. TWB	0	0	0	2	2
2. TL	1	0	0	4	4
3. FG	1	0	0	4	5
4. MWV	1	0	0	4	6
5. LF	0	0	0	3	3
6. SPT	2	0	0	50	50
7. YC	1	0	0	8	8
8. TW	1	0	0	20	20
9. SLT	0	0	0	1	2
10. DY1	30	2	2	60	100
11. DY2	30	4	4	50	90
12. DY3	8	1	1	20	30

Table 2.17 Combined 24-hr Averaged RSP ($\mu\text{g}/\text{m}^3$) Concentration - Background Level Excluded (Without Mitigation)

Sensitive Receiver	North Lantau Road	Tsing Ma Bridge Ma Wan Viaducts Kap Shui Mun Bridge	Route 3	Combined
1. TWB	2	40	10	50
2. TL	4	10	10	30
3. FG	5	20	10	30
4. MWV	6	20	8	30
5. LF	3	20	6	30
6. SPT	50	2	4	60
7. YC	8	1	4	10
8. TW	20	1	3	20
9. SLT	2	140	8	140
10. DY1	100	1	4	100
11. DY2	90	1	3	100
12. DY3	30	0	2	30

Table 2.18 Combined 24-hr Averaged RSP ($\mu\text{g}/\text{m}^3$) Concentration - Background Level Excluded (With Mitigation)

Sensitive Receiver	North Lantau Road	Tsing Ma Bridge Ma Wan Viaducts Kap Shui Mun Bridge	Route 3	Combined
1. TWB	1	40	10	50
2. TL	2	10	10	30
3. FG	2	20	10	30
4. MWV	2	20	8	30
5. LF	1	20	6	30
6. SPT	20	2	4	20
7. YC	3	1	4	10
8. TW	6	1	3	10
9. SLT	1	140	8	140
10. DY1	50	1	4	60
11. DY2	50	1	3	50
12. DY3	10	0	2	20

2.7.3 24 Hour Dust Levels

Modelling results for 24 hour average TSP and RSP concentrations with and without mitigation are shown on Tables 2.13 to 2.18 and contours showing the distribution of the dust are illustrated on Figures 2.22 to 2.25. These all exclude background levels. The following conclusions have been made:-

- (a) The impact on the ASRs on North Lantau from the excavation activities of Route 3 and the construction activities in Period 2 or Period 3 of the LFC (excluding the North Lantau Road) are predicted to be negligible. Hence the dust levels for 24-hour averages at ASRs on North Lantau may be assessed by considering dust from the construction activities of the North Lantau Road alone (Figures 2.26 and 2.27).
- (b) There is likely to be exceedance of the 24 hour AQOs at two ASRs (DY1, DY2) on North Lantau. The highest level received at DY1 will be about $460 \mu\text{g}/\text{m}^3$ TSP (including the background level).
- (c) With 70% mitigation of dust, DY1 and DY2 will still receive about $360 \mu\text{g}/\text{m}^3$ TSP (including background level). The two activities causing the dust problem are blasting and hauling (Figure 2.28);
- (d) The 24 hour AQO for RSP could be met without mitigation at the shipyards DY1 and DY2 (Figure 2.29); and
- (e) The North Lantau Road will only have a small impact on 24 hour dust levels on Ma Wan.

2.7.4 Mitigation Measures

The assessment has shown that 24-hour air quality objectives for TSP and RSP will generally not be exceeded as long as the assumed mitigation measures are applied as discussed in Section 2.6.2.

The recommended 1-hour objective of $500 \mu\text{g}/\text{m}^3$ will be exceeded at all receivers because of the dust from blasting. This cannot easily be mitigated.

The dockyards at Tsing Chau Wan will be affected by dust from the North Lantau Road and the maximum 1-hour dust levels (TSP) could reach $1320\text{-}1770 \mu\text{g}/\text{m}^3$. The 24-hour dust levels will, however, be much lower. The air quality objectives have been set at levels to protect the health of the population and cannot be used to determine the impact on operations at the dockyards such as painting. No guidance on the tolerance of these activities to dust is available. Sensitive painting operations should in any case be carried out in a dust free enclosure.

The only additional mitigation measure that could be applied to reduce dust levels at the dockyards would be to move the crushing plant to another part of the site. This, however, would only make a small difference.

Construction contracts include provisions for monitoring of dust and these need to be developed into comprehensive monitoring and audit programmes in the Engineer's operating manual.

2.8 Operational Phase Assessment

2.8.1 Methodology

The EPA concluded that levels of CO, NO₂ and lead will be within the AQO except locally in close proximity to the road and at the toll plaza. The previous results have been reviewed taking the latest traffic figures and the impact from Route 3 into account. The review has also used the latest information on emission factors.

Maximum 1-hour levels of CO and NO₂, 8 hour levels of CO and 24 hour levels of NO₂ and particulate matter have been determined using CALINE 4 and the predictions superimposed on background levels.

The input parameters used for the modelling are shown in Appendix D.

Vehicle emissions depend heavily on vehicle type (LGV, MGV, HGV and diesel or petrol cars), and vehicle speed. In addition, the emissions vary from individual vehicles by vehicle age and condition of the engine. Hence the total emissions will depend on the vehicle speed, vehicle mix (Table 2.19) and vehicle flow rate based on the year 2006 (Table 2.20). Vehicle emission factors for this assessment all have been derived from the EEC Environment and Quality of life " Corinair Working Group on Emissions Factors for Calculating 1985 Emissions from Road Traffic" 1989. Details are shown in Appendix D. It has been assumed that all petrol driven cars will be equipped with a catalytic convertor and the average vehicle will meet the emission standards. Traffic speed has been estimated to be 60 km/hour as the road will be operating at high volume/capacity ratios.

The toll plaza has been divided into eight segments which simulate the changing width of the plaza. The average vehicle speed at the toll plaza is assumed to be 25 km/hr.

Table 2.19 Average Traffic Mix

Vehicle Types	Percentage
Car	17
LGV + Taxis	42
MGV	27
HGV	14

Table 2.20 Traffic Flow During Operation Phase

Time	Vehicles/hour
1-hr average	7189
8-hr average	6029
24-hr average	4405

2.8.2 Operation Stage Impact Assessment and Evaluation

Results of the modelling are shown in Table 2.21.

Table 2.21 Modelling Results - Operation Stage (including background)

Receiver	CO(1hr) (ppm)	CO (8hr) (ppm)	NO ₂ (1 hr) (ppm)	NO ₂ (24 hr) (ppm)	RSP (24 hr) µg/m ³
1. TWB	1.7	1.3	0.10	0.05	90
2. TL	1.6	1.2	0.08	0.04	80
3. FG	1.6	1.2	0.09	0.04	80
4. MWV	1.7	1.2	0.09	0.05	90
5. LF	1.8	1.4	0.15	0.08	130
6. SPT	1.7	1.3	0.10	0.05	90
7. YC	1.7	1.3	0.11	0.06	100
8. TW	1.6	1.2	0.08	0.04	80
9. SLT	1.7	1.3	0.11	0.06	100
10. DY1	1.6	1.2	0.08	0.04	80
11. DY2	1.6	1.2	0.08	0.04	80
12. DY3	1.7	1.2	0.08	0.04	80
AQO	26.2	8.7	0.16	0.08	180
Background	1.6	1.2	0.07	0.03	70

The predicted levels of CO and RSP are all within the AQOs. Predictions for NO₂ are within the AQOs except at Lau Fa where the levels of NO₂ for 1-Hour and 24-Hour are marginally acceptable. However the scale of impact will be small as only a few people will be affected.

Typical profiles of NO₂ & RSP against the downwind distance from the LFC are shown on Figures 2.30 to 2.31. The figures show there will not be any exceedance of AQOs further than 50m from the centreline of the LFC.

It should be noted that there is a height constraint of 10m in CALINE 4 which means that dispersion of pollutants may be higher than predicted in areas where the road will be more than 10m above the surround ground. Consequently the predicted levels in the vicinity of the Ma Wan viaduct will tend to be overestimated.

Conclusions would be made:-

There could be very poor air quality at Toll Plaza. Care will be needed in the detail design of the toll plaza to maximize dispersion of pollutants. The deep cut in the section between the landing of the Kap Shui Mun Bridge and toll plaza will limit air dispersion and high level of air pollution have been predicted in this area. There will be restricted to the road itself and will not affect any sensitive receivers.

Figures 2.32 to 2.36 illustrate the predicted concentrations of pollutants along the LFC. Daily traffic variations are such that results from 1 and 8 hour averaging times differ only slightly.

The differences between the results from the EPA and this study are due to the following:-

- (a) the present study has adopted the most recent emission data with recognized improvements in vehicle emissions; and
- (b) the traffic mix for the present assessment has been based on more recent data which has included a more detailed breakdown into diesel and petrol cars, LGV, MGV and HGV.

2.8.3 Combined Operation Stage Impacts from Route 3

Operational impacts from Route 3 were given in the Route 3 Technical Report No. 19-Environmental Impact Assessment. The impacts from Route 3 were predicted to be minimal beyond about 400m from the road. The ASRs on Ma Wan and North Lantau are well beyond this distance, hence the emission impacts from Route 3 on ASRs in the Study Area is not likely to be large. There will be some general increase in background air pollution levels but these are not likely to be of sufficient magnitude to cause exceedance of the AQOs at any of the NSRs.

2.8.4 Mitigation Measures During Operation

The assessment has concluded that CO, NO₂ and RSP emissions from vehicles during operation will have only limited impacts on Ma Wan and North Lantau. No special mitigation measures will therefore be required. Pollution levels of RSP(24 hr) and NO₂ (24 hr) will, however, be relatively high at Lau Fa due to its close proximity to the road.

FIGURE 2.1

STUDY AREA AND LOCATIONS OF SENSITIVE RECEIVERS

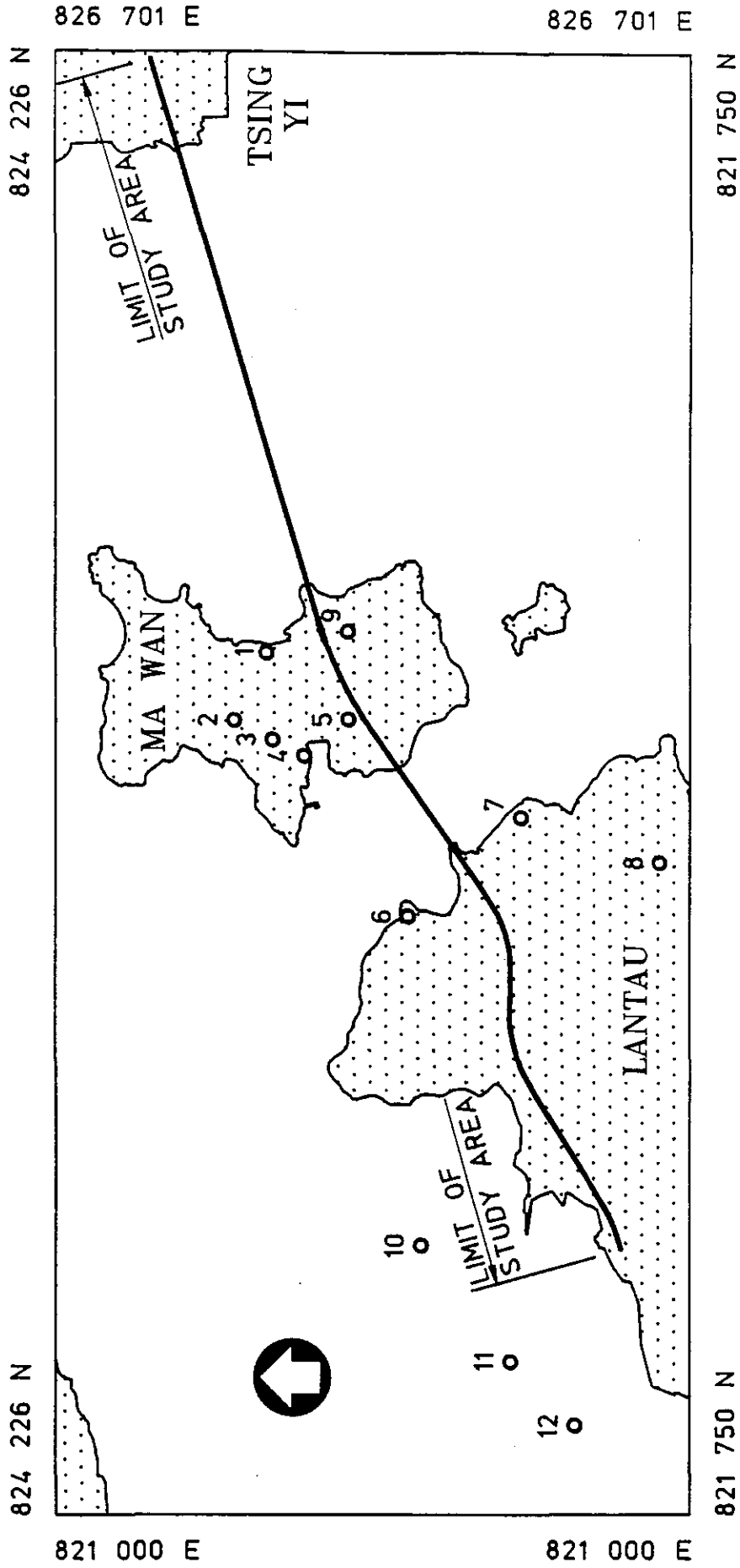

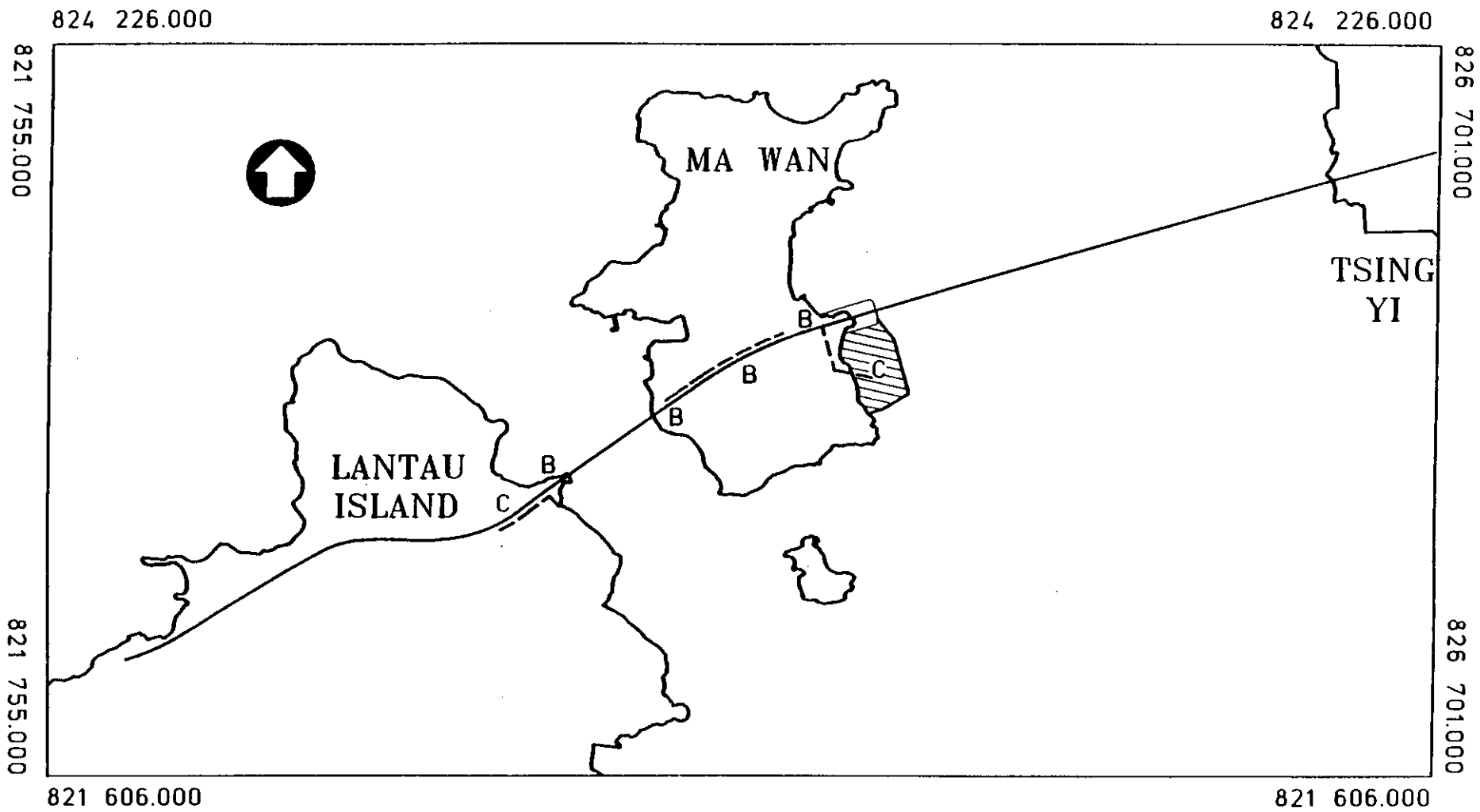

Legend :

- B** Blasting and Drilling
- C** Concrete Batching Plant
- Haul Road
- ▨ Reclamation

KEY CONSTRUCTION ACTIVITIES DURING PERIOD 1 EXCLUDING NLR

FIGURE 2.2

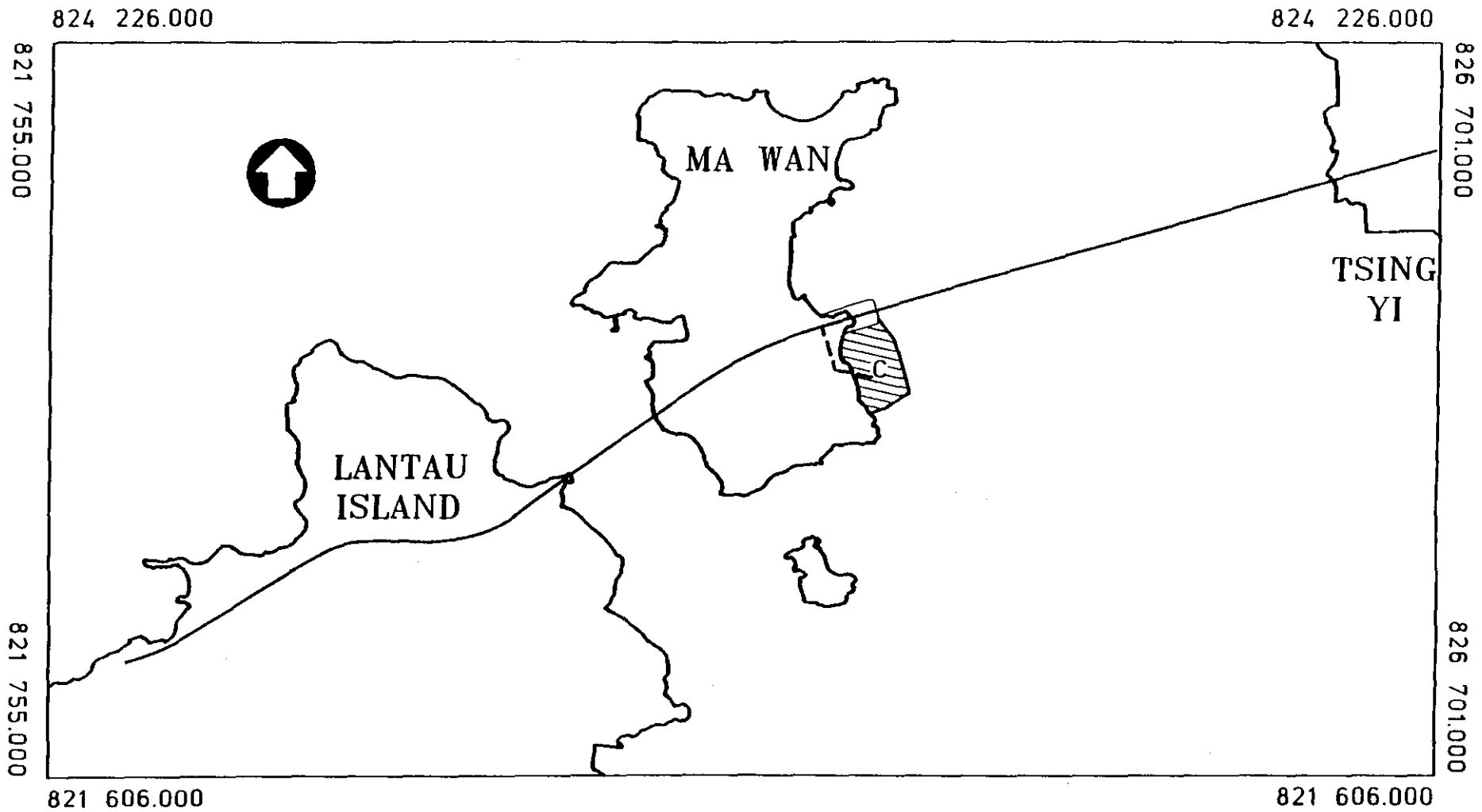

Legend :

- C Concrete Batching Plant
- ▨ Reclamation
- Haul Road

KEY CONSTRUCTION ACTIVITIES DURING PERIOD 2 EXCLUDING NLR

FIGURE 2.3

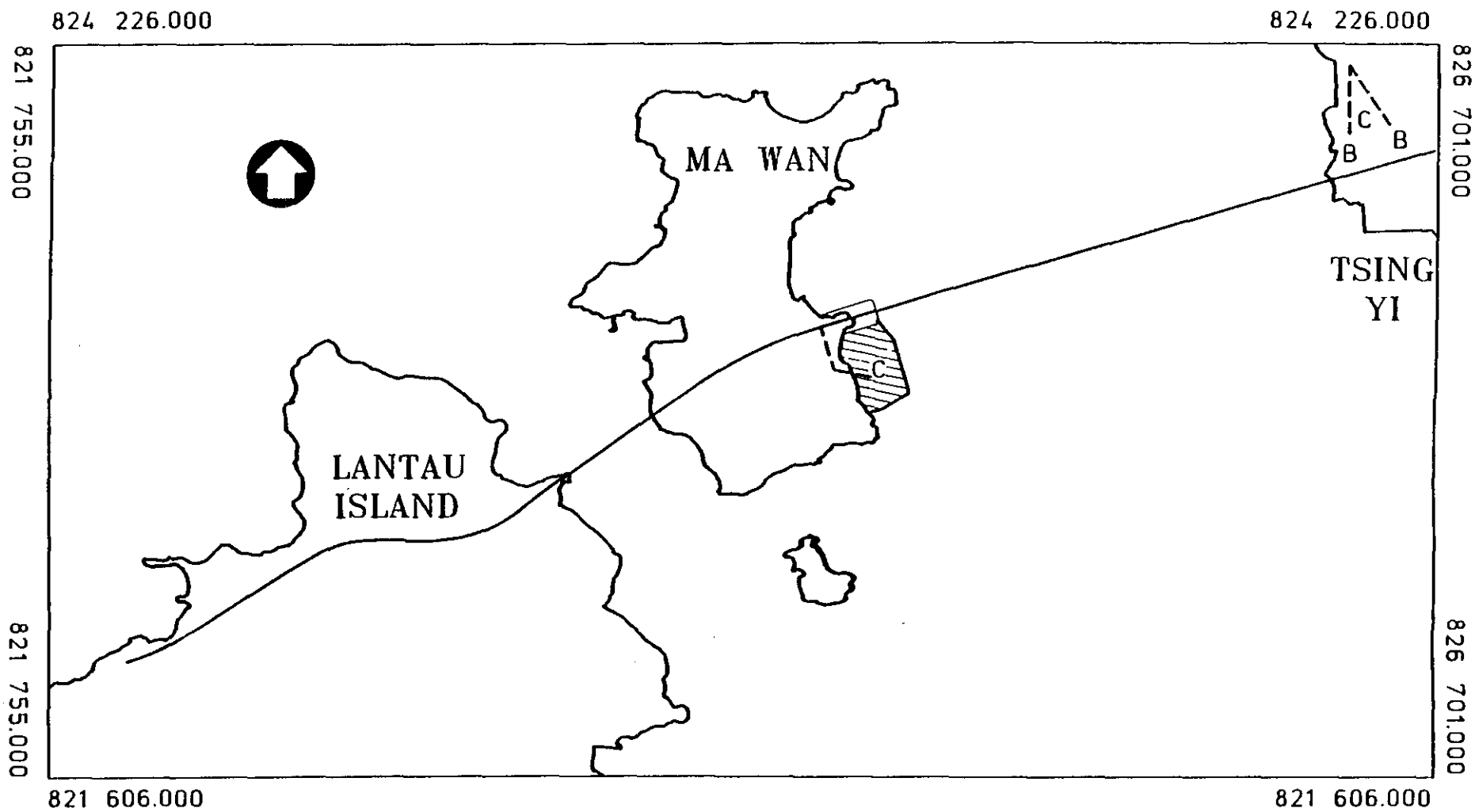

Legend :

- B Blasting and Drilling
- C Concrete Batching Plant
- Haul Road
- ▨ Reclamation

KEY CONSTRUCTION ACTIVITIES DURING PERIOD 3 EXCLUDING NLR

FIGURE 2.4

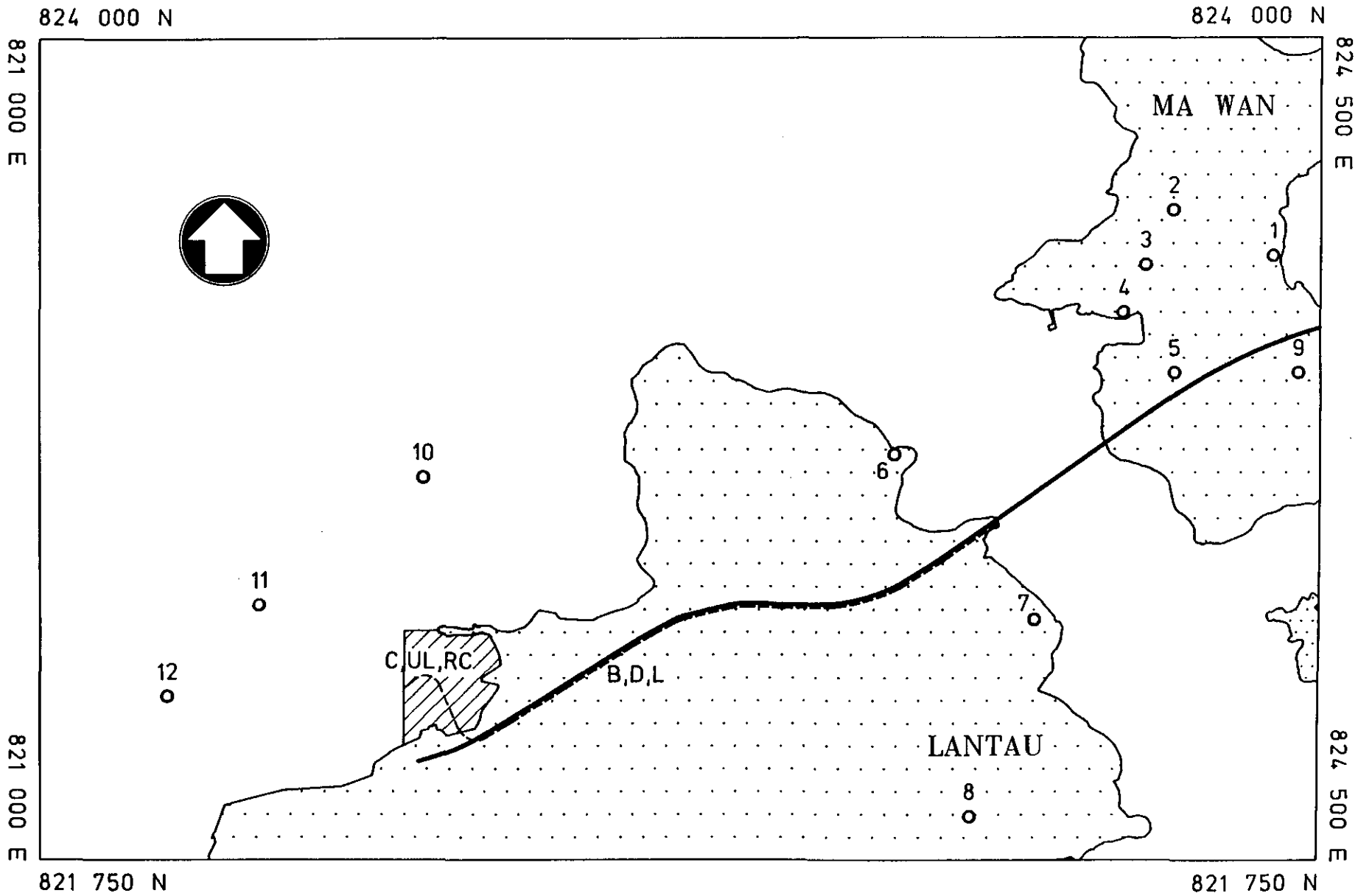

Legend :



-----	Haul Road	C	Concrete Batching	RC	Rock Crushing
▨	Reclamation	D	Drilling	UL	Unloading
B	Blasting	L	Loading		

KEY CONSTRUCTION ACTIVITIES DURING NORTH LANTAU ROAD CONSTRUCTION

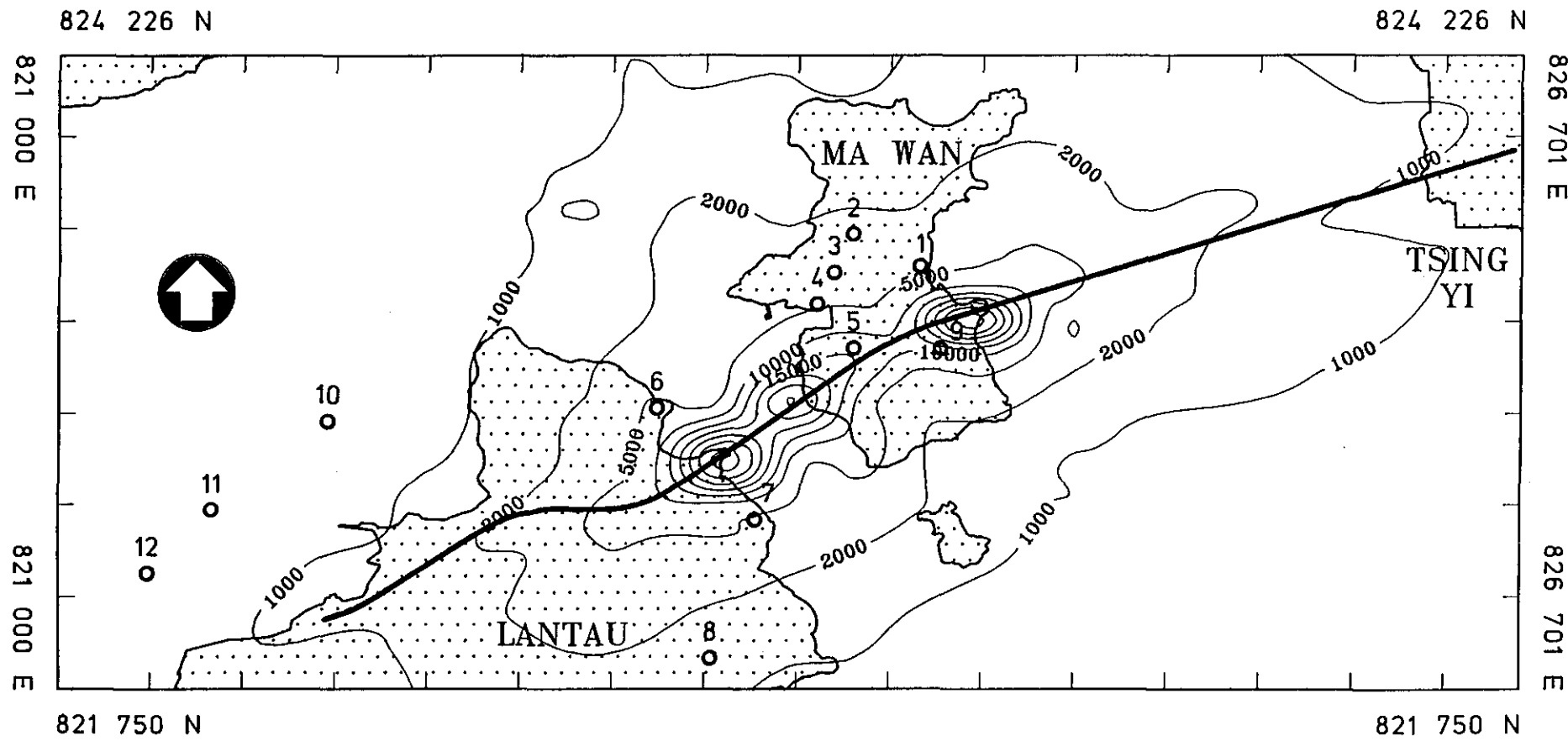
FIGURE 2.5



Legend :



-  Lantau Fixed Crossing
-  Air Sensitive Receiver
-  Contour Level in $\mu\text{g}/\text{m}^3$
- 821 750 N Coordinates in H.K. Metric Grid

HIGHEST 1-HOUR TSP LEVEL DISTRIBUTION DURING PERIOD 1 EXCLUDING NLR

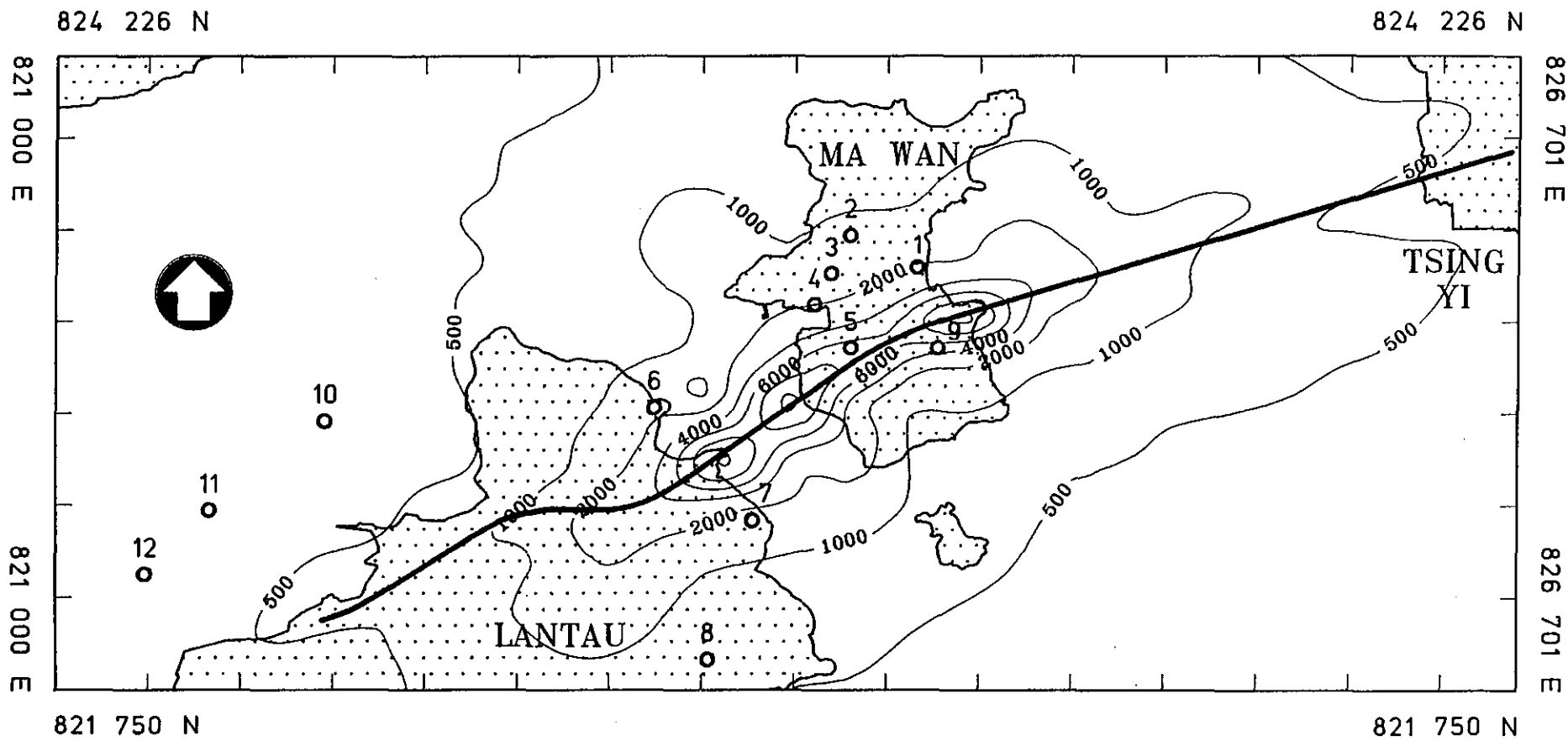
FIGURE 2.6

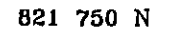

Legend :

-  Lantau Fixed Crossing
-  Air Sensitive Receiver
-  Contour Level in $\mu\text{g}/\text{m}^3$
-  Coordinates in H.K. Metric Grid



HIGHEST 1-HOUR RSP LEVEL DISTRIBUTION DURING PERIOD 1 EXCLUDING NLR

FIGURE 2.7

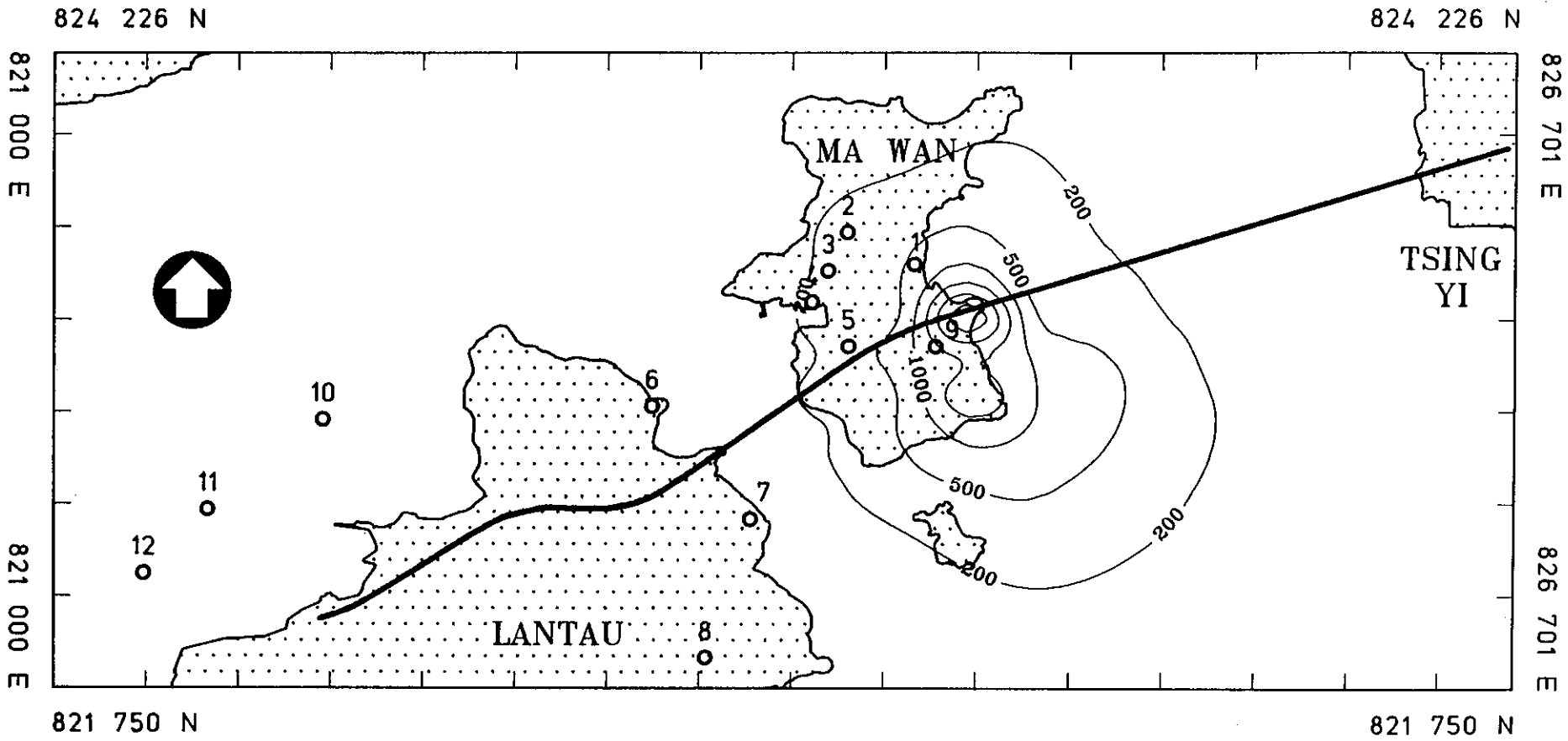
HIGHEST 1-HOUR TSP LEVEL DISTRIBUTION DURING PERIOD 2 EXCLUDING NLR
 FIGURE 2.8



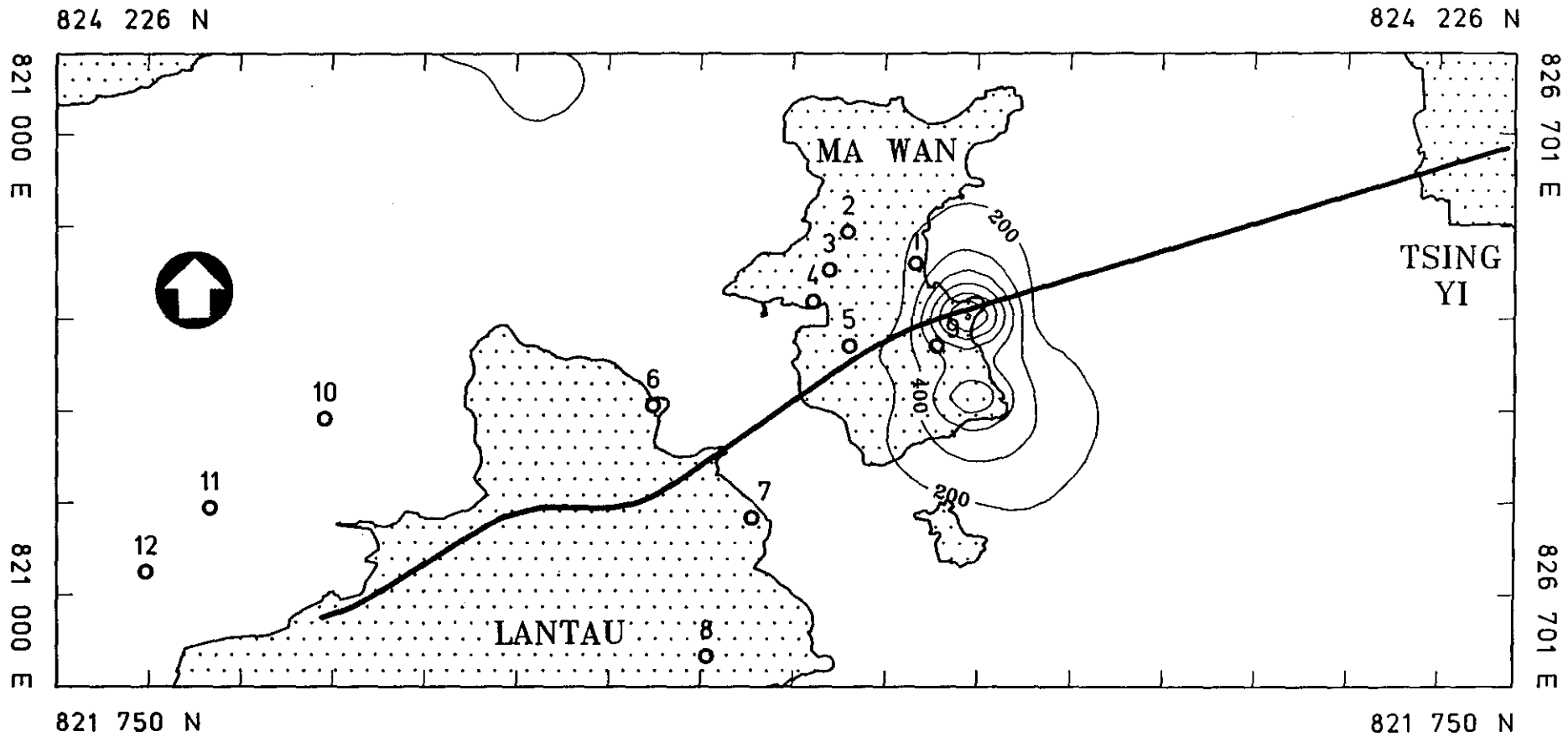

Legend :

-  Lantau Fixed Crossing
-  Air Sensitive Receiver
-  Contour Level in $\mu\text{g}/\text{m}^3$
- 821 750 N Coordinates in H.K. Metric Grid



Legend :



-  Lantau Fixed Crossing
-  Air Sensitive Receiver
-  200 Contour Level in $\mu\text{g}/\text{m}^3$
- 821 750 N Coordinates in H.K. Metric Grid

HIGHEST 1-HOUR RSP LEVEL DISTRIBUTION DURING PERIOD 2 EXCLUDING NLR

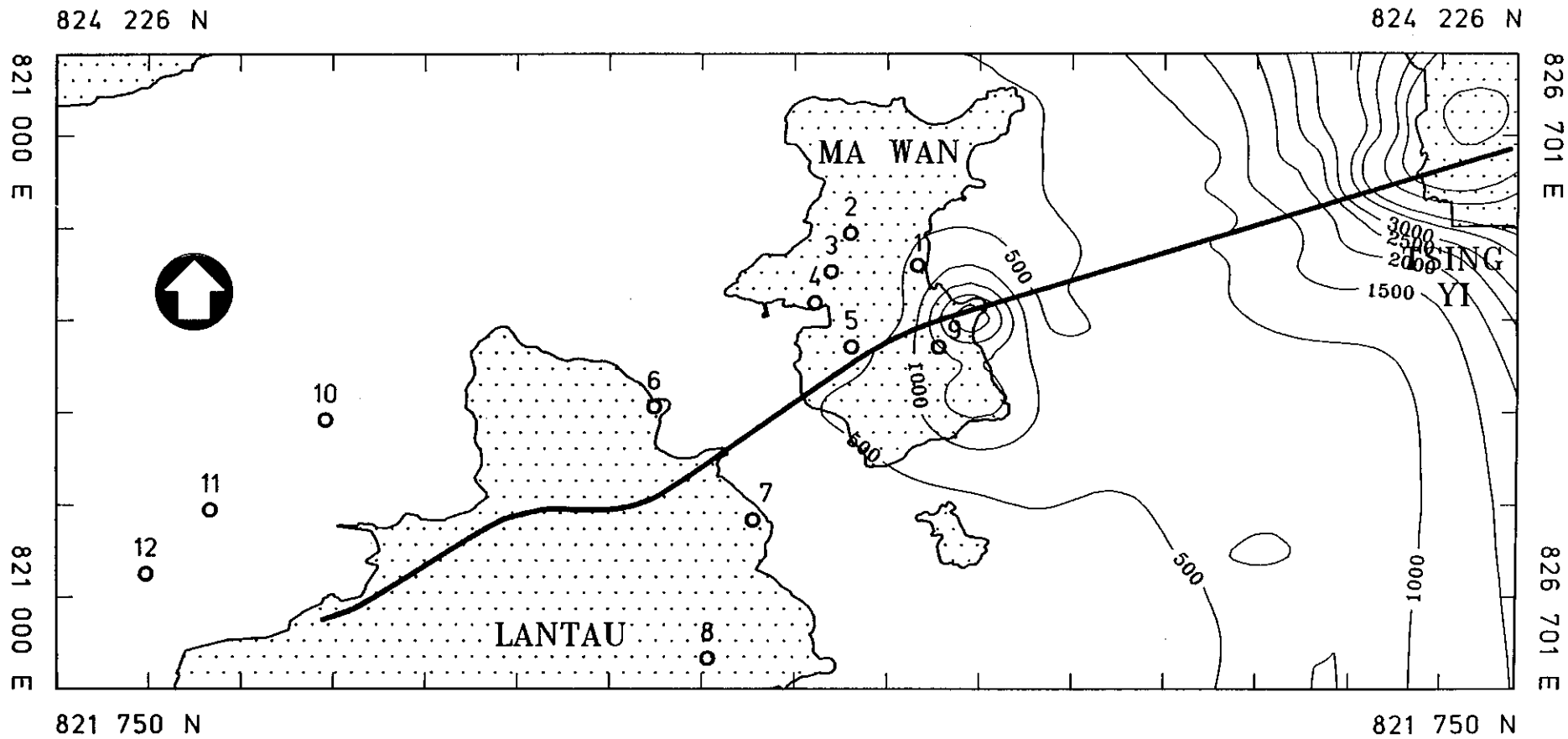
FIGURE 2.9



Legend :

-  Lantau Fixed Crossing
-  Air Sensitive Receiver
-  Contour Level in $\mu\text{g}/\text{m}^3$
- 821 750 N Coordinates in H.K. Metric Grid

HIGHEST 1-HOUR TSP LEVEL DISTRIBUTION DURING PERIOD 3 EXCLUDING NLR

FIGURE 2.10

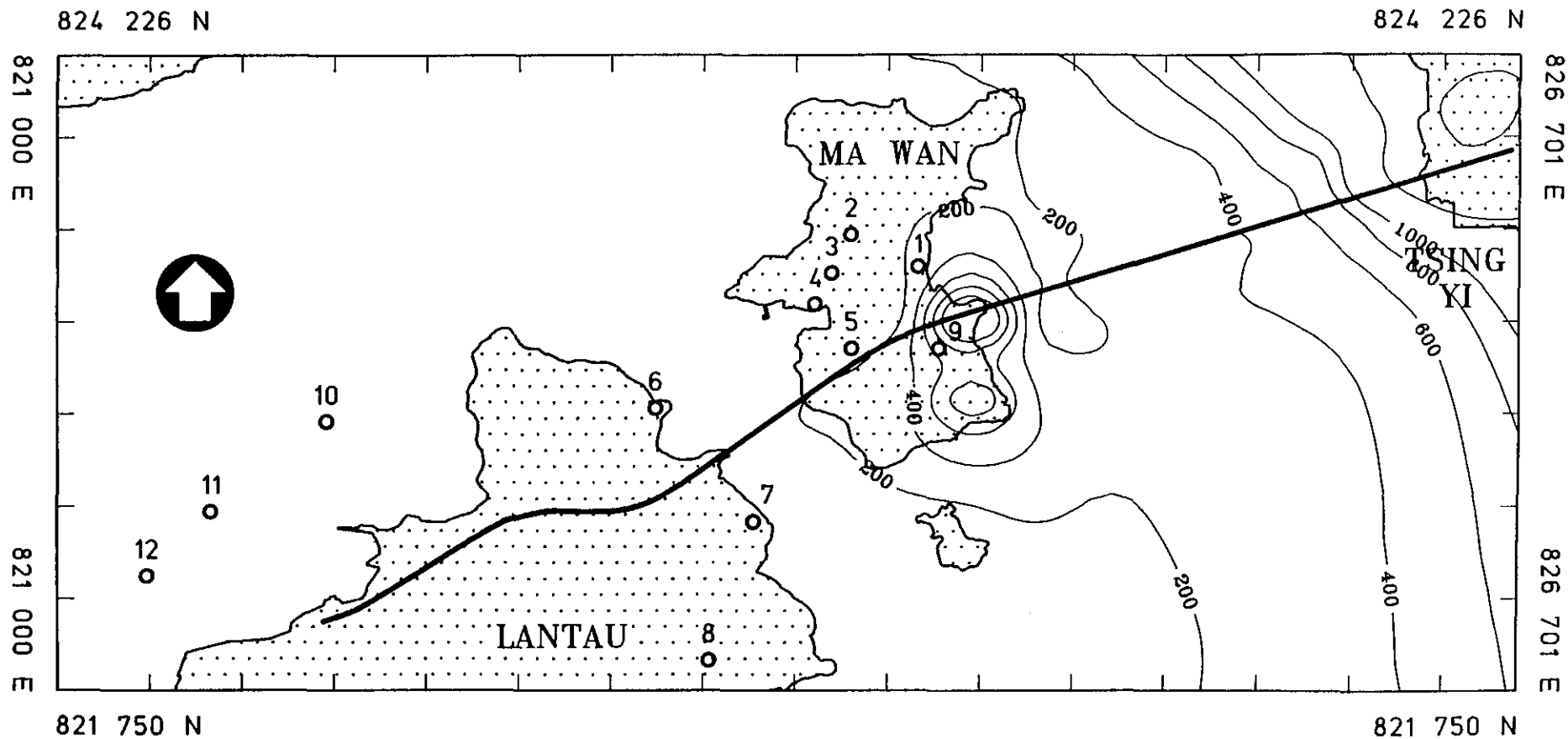

Legend :

- Lantau Fixed Crossing
- ⁸ Air Sensitive Receiver
- 200 — Contour Level in $\mu\text{g}/\text{m}^3$
- 821 750 N Coordinates in H.K. Metric Grid

HIGHEST 1-HOUR RSP LEVEL DISTRIBUTION DURING PERIOD 3 EXCLUDING NLR

FIGURE 2.11

FIGURE 2.12

PREDICTED 24-HOUR TSP CONCENTRATION IN PERIOD 1 EXCLUDING NLR

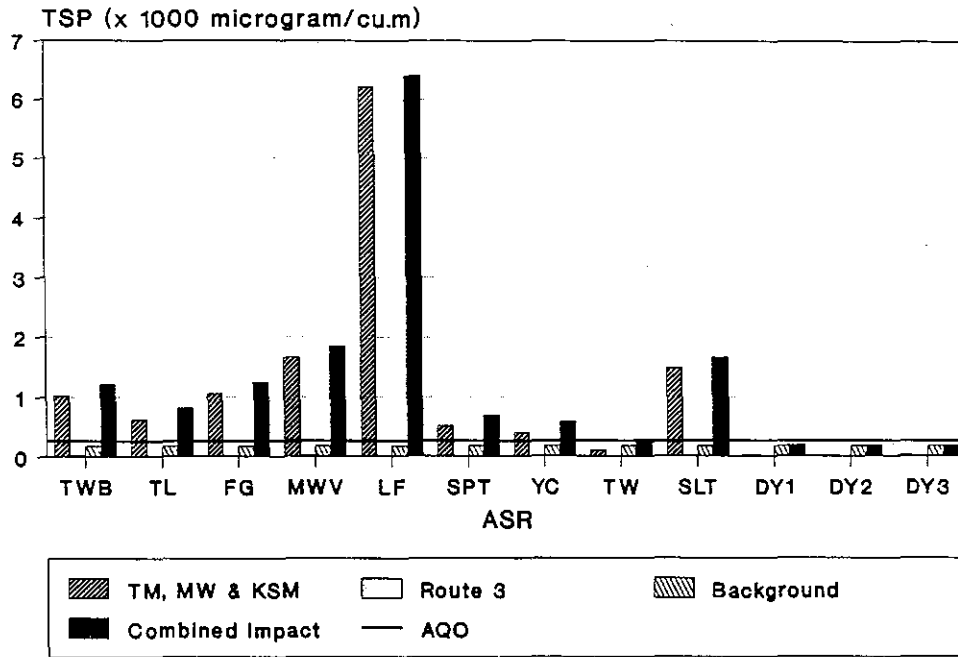
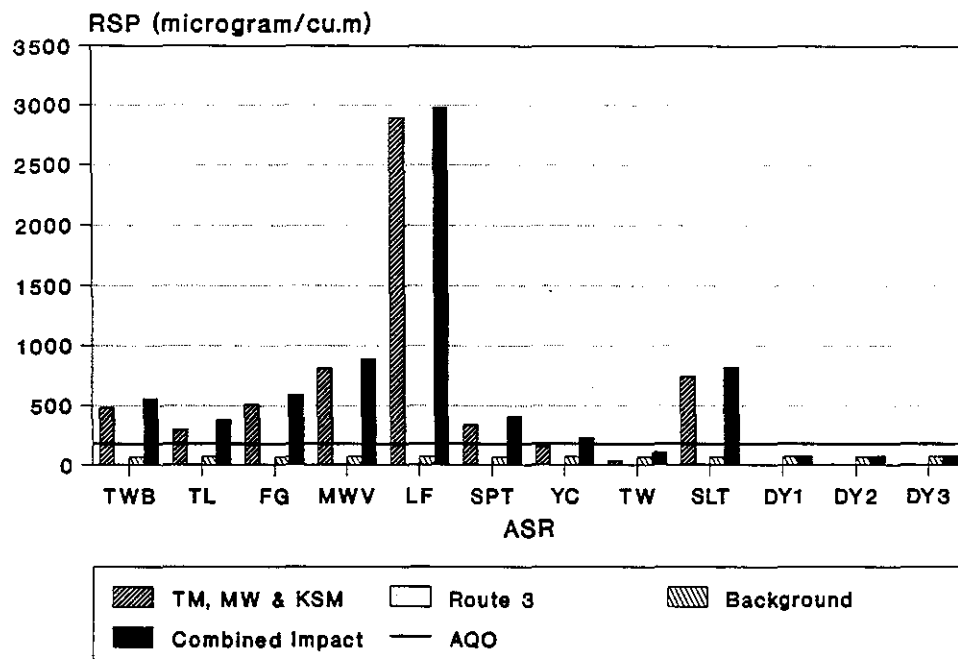

FIGURE 2.13

PREDICTED 24-HOUR RSP CONCENTRATION IN PERIOD 1 EXCLUDING NLR



Note: NL - North Lantau Road
 TM - Tsing Ma Bridge
 MW - Ma Wan Viaducts
 KSM - Kap Shui Mun Bridge

PREDICTED 24-HOUR TSP CONCENTRATION IN PERIOD 2 EXCLUDING NLR

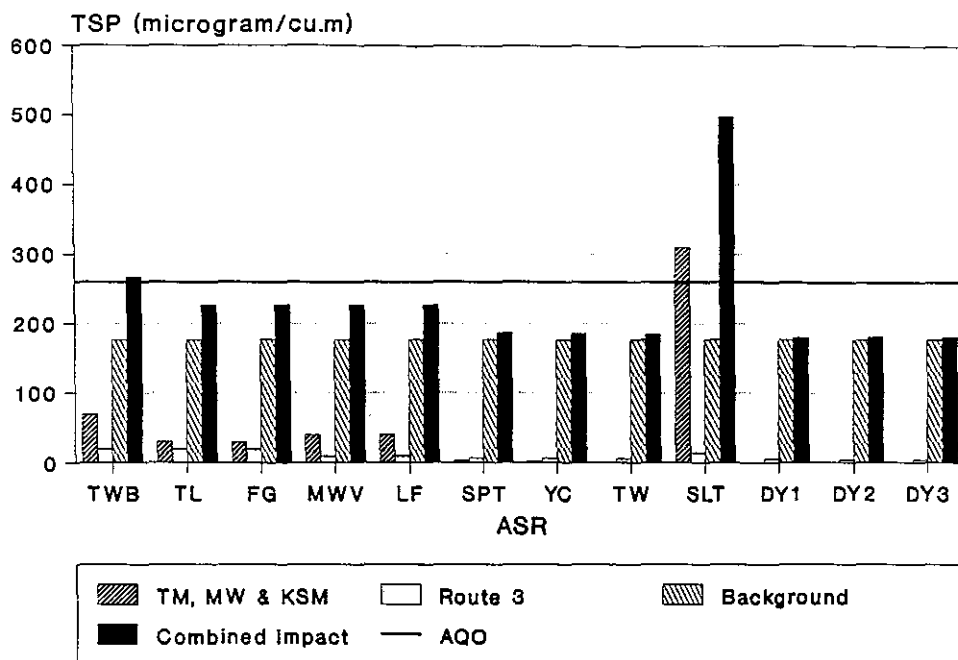
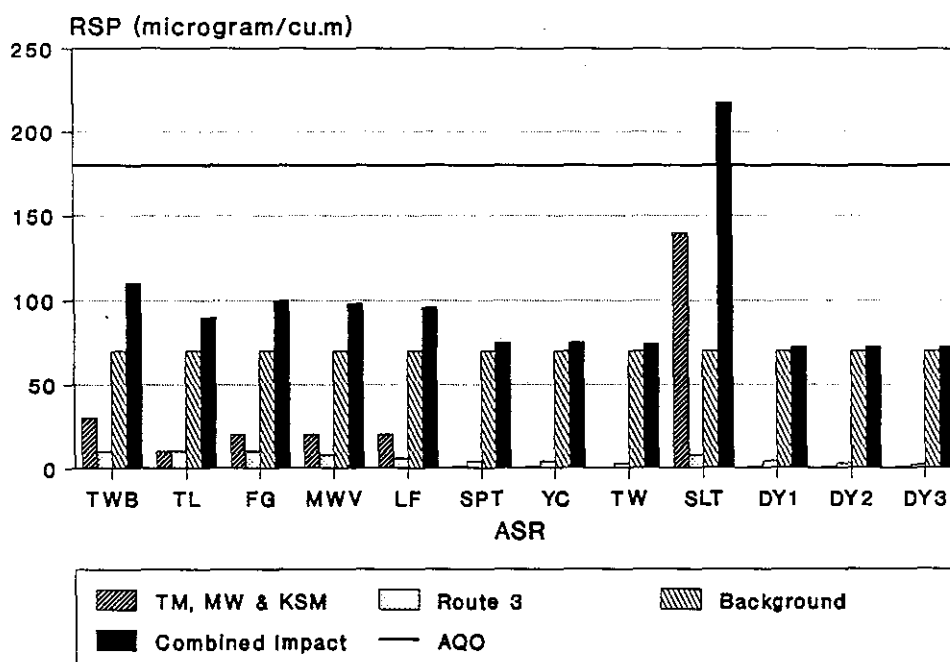

FIGURE 2.15

PREDICTED 24-HOUR RSP CONCENTRATION IN PERIOD 2 EXCLUDING NLR



Note: NL - North Lantau Road
 TM - Tsing Ma Bridge
 MW - Ma Wan Viaducts
 KSM - Kap Shui Mun Bridge

FIGURE 2.16

PREDICTED 24-HOUR TSP CONCENTRATION IN PERIOD 3 EXCLUDING NLR

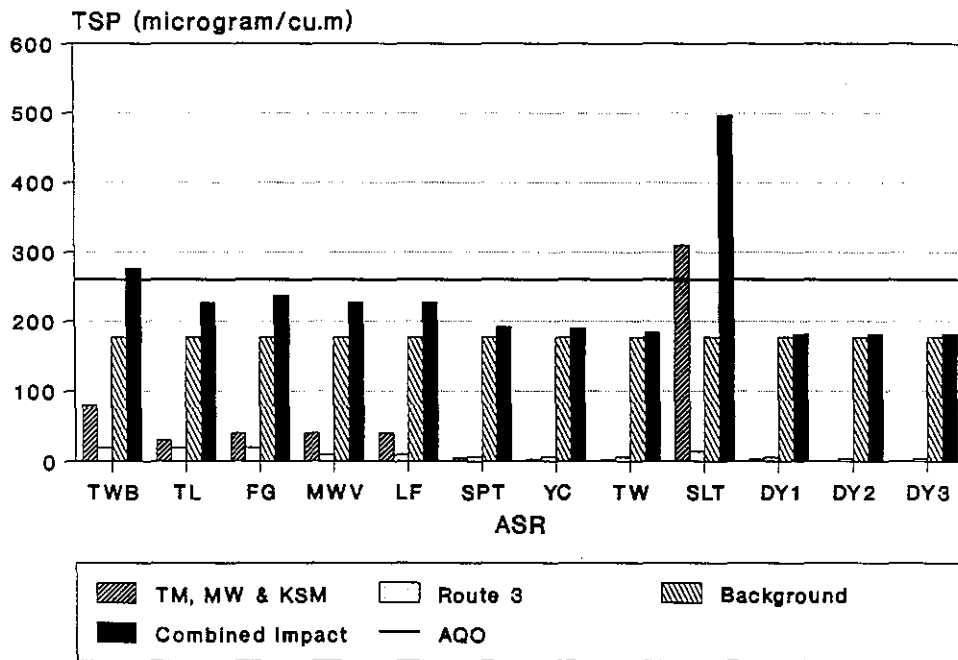
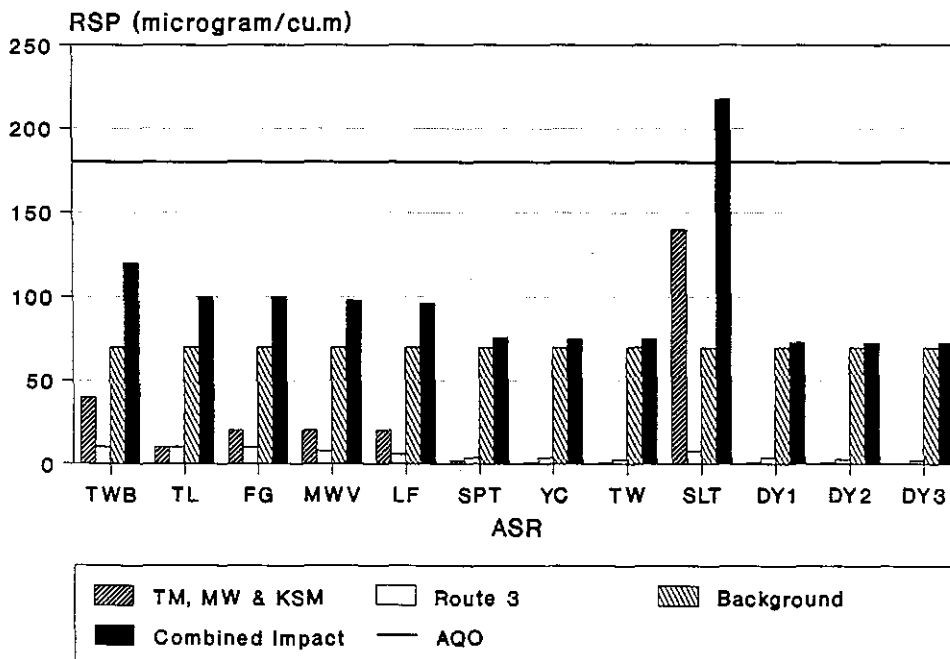
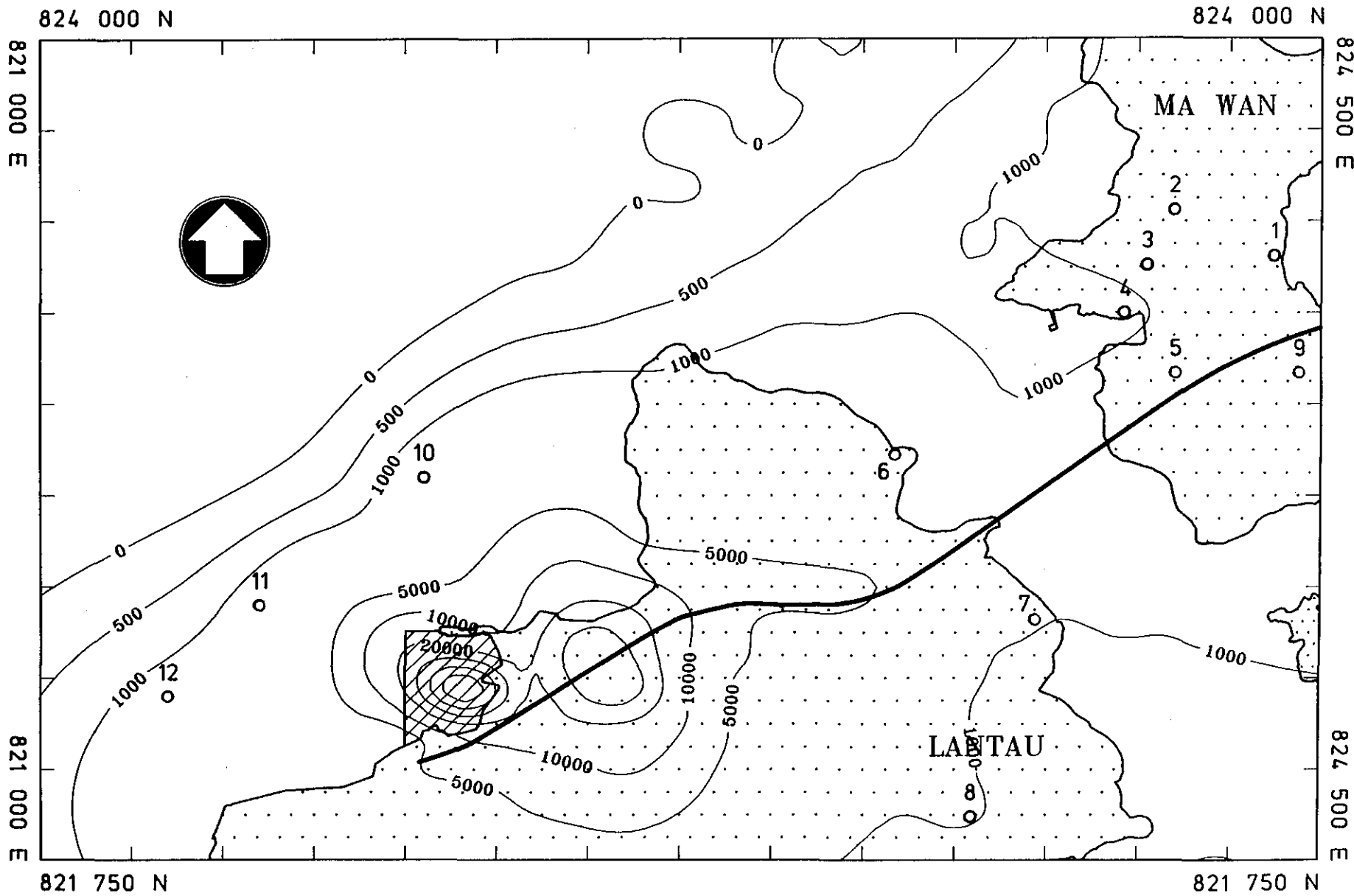

FIGURE 2.17



PREDICTED 24-HOUR RSP CONCENTRATION IN PERIOD 3 EXCLUDING NLR





Note: NL - North Lantau Road
 TM - Tsing Ma Bridge
 MW - Ma Wan Viaducts
 KSM - Kap Shui Mun Bridge



Legend :

-  Lantau Fixed Crossing
-  Air Sensitive Receiver
-  Contour Level in $\mu\text{g}/\text{m}^3$



-  Coordinates in H.K. Metric Grid
-  Reclamation

HIGHEST 1-HOUR TSP LEVEL DISTRIBUTION DURING PERIOD 3 INCLUDING NLR

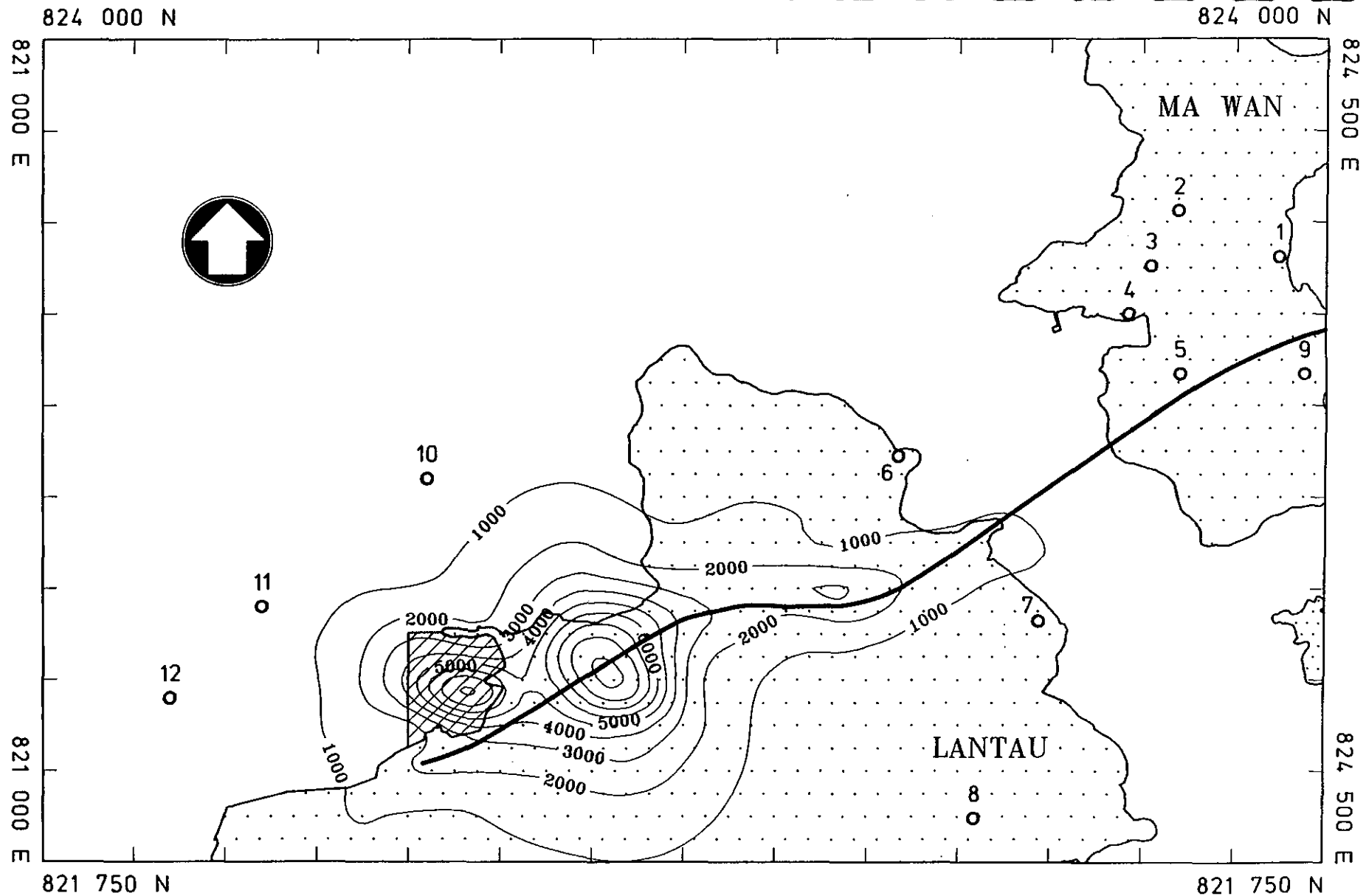
FIGURE 2.18



Legend :

-  Lantau Fixed Crossing
-  Air Sensitive Receiver
-  Contour Level in $\mu\text{g}/\text{m}^3$

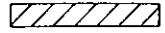
-  Coordinates in H.K. Metric Grid
-  Reclamation

HIGHEST 1-HOUR RSP LEVEL DISTRIBUTION DURING PERIOD 3 INCLUDING NLR

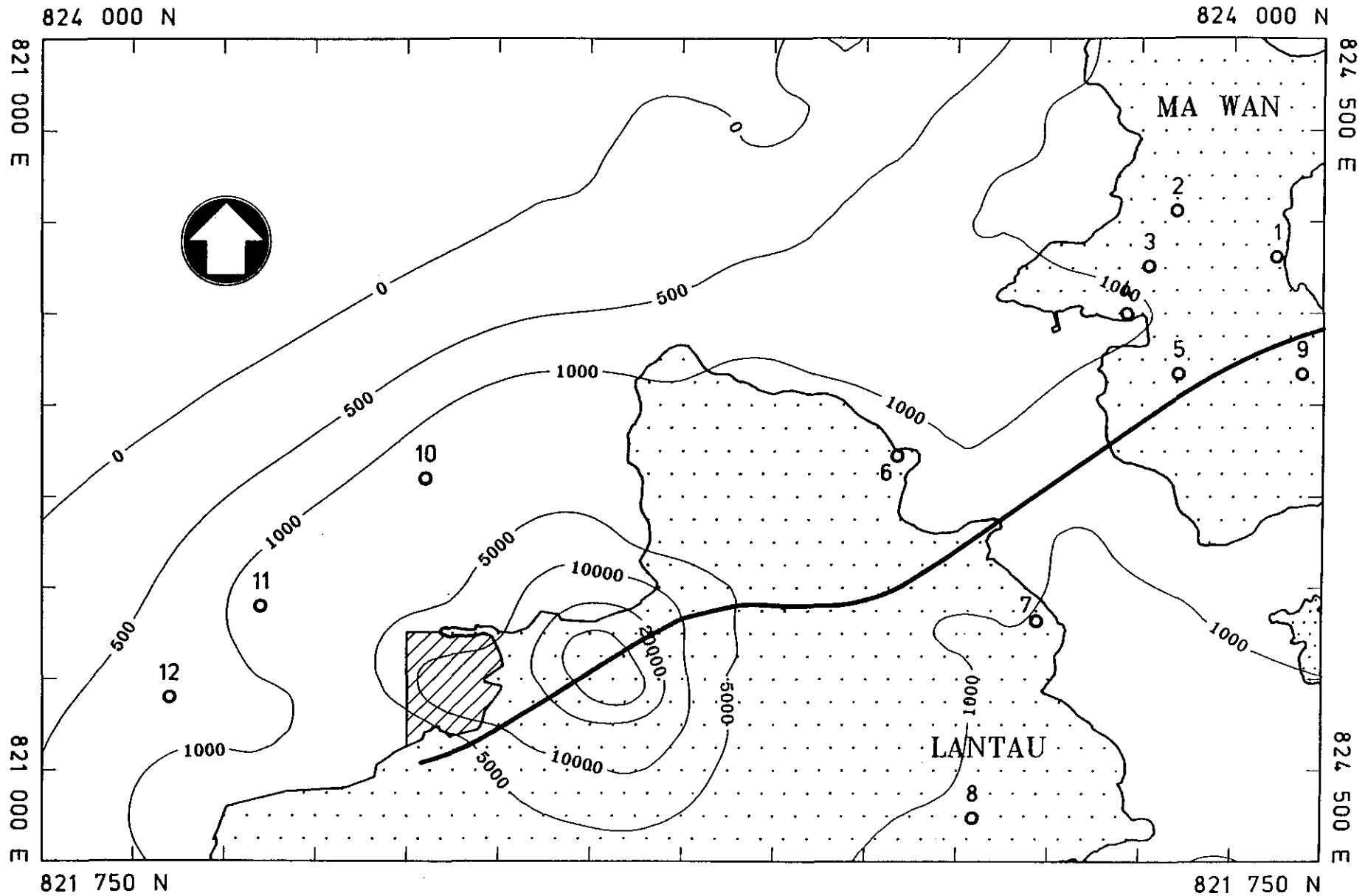

FIGURE 2.19



HIGHEST 1-HOUR TSP LEVEL DISTRIBUTION DURING PERIOD 3 INCLUDING NLR WITH MITIGATION

FIGURE 2.20

Legend :

-  Lantau Fixed Crossing
-  Air Sensitive Receiver
-  Contour Level in $\mu\text{g}/\text{m}^3$



821 750 N Coordinates in H.K. Metric Grid



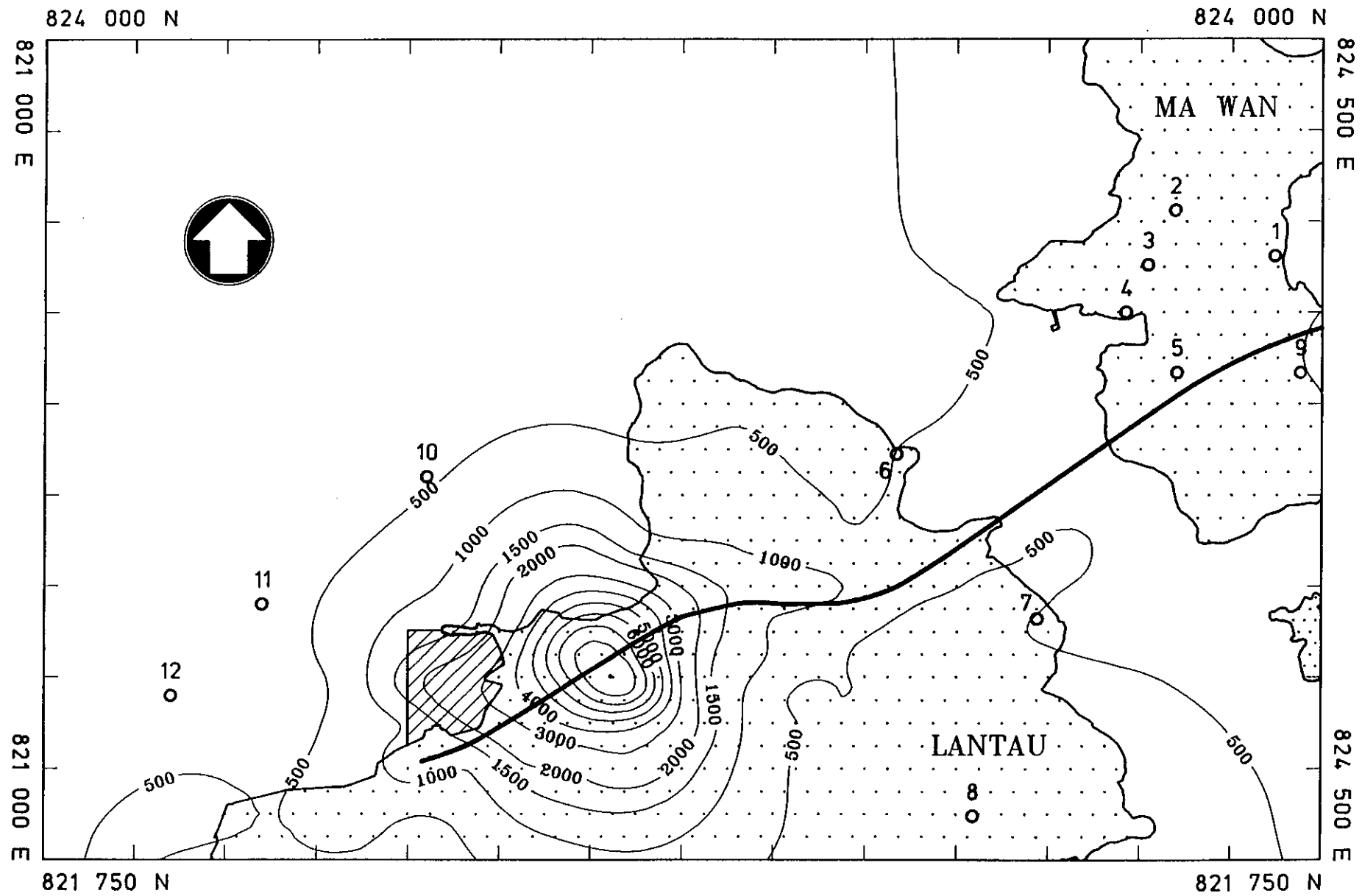

Reclamation

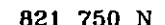

Legend :

-  Lantau Fixed Crossing
-  Air Sensitive Receiver
-  1000 — Contour Level in $\mu\text{g}/\text{m}^3$



-  821 750 N Coordinates in H.K. Metric Grid
-  Reclamation

HIGHEST 1-HOUR RSP LEVEL DISTRIBUTION DURING PERIOD 3 INCLUDING NLR WITH MITIGATION

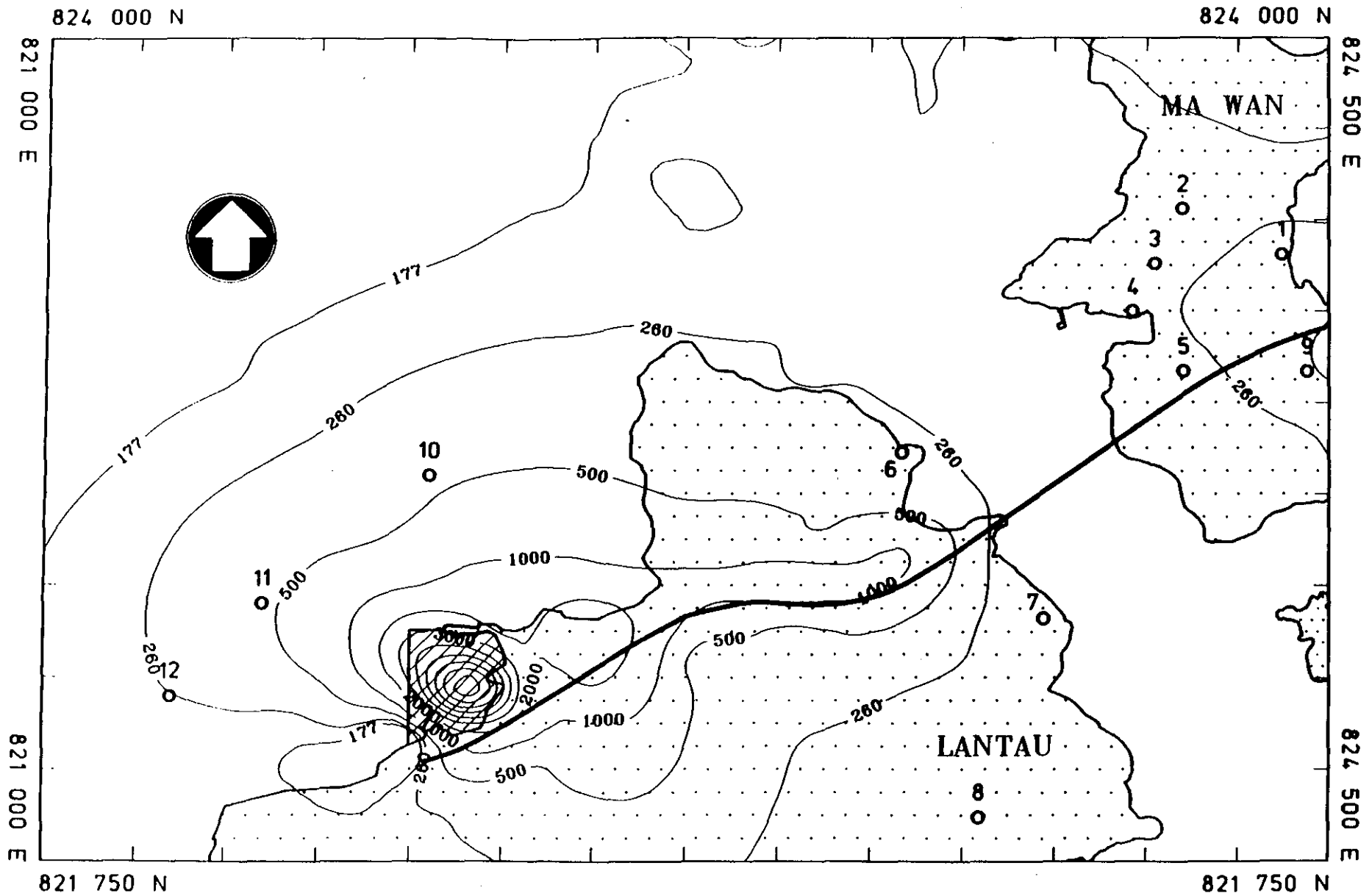
FIGURE 2.21



Legend :

-  Lantau Fixed Crossing
-  Air Sensitive Receiver



-  Reclamation
- 821 750 N Coordinates in H.K. Metric Grid

FIGURE 2.22 24-HOUR AVERAGE TSP DISTRIBUTION DURING PERIOD 3 INCLUDING NLR

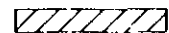
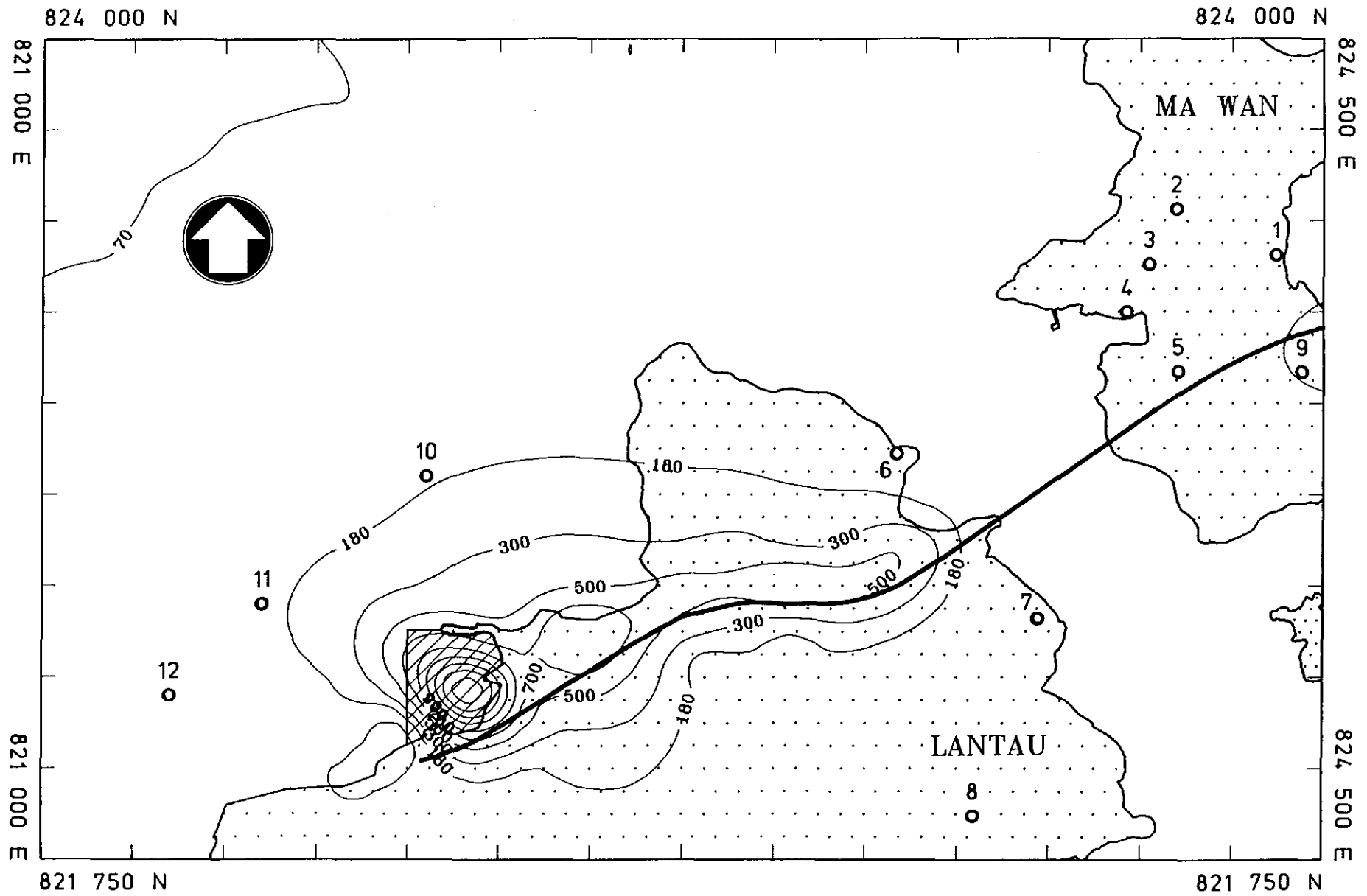

Legend :

-  Lantau Fixed Crossing
-  Air Sensitive Receiver
-  Contour Level in $\mu\text{g}/\text{m}^3$

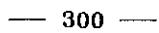
-  Reclamation
- Coordinates in H.K. Metric Grid

FIGURE 2.23 24-HOUR AVERAGE RSP DISTRIBUTION DURING PERIOD 3 INCLUDING NLR



24-HOUR AVERAGE TSP DISTRIBUTION DURING PERIOD 3 INCLUDING NLR WITH MITIGATION

FIGURE 2.24

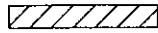
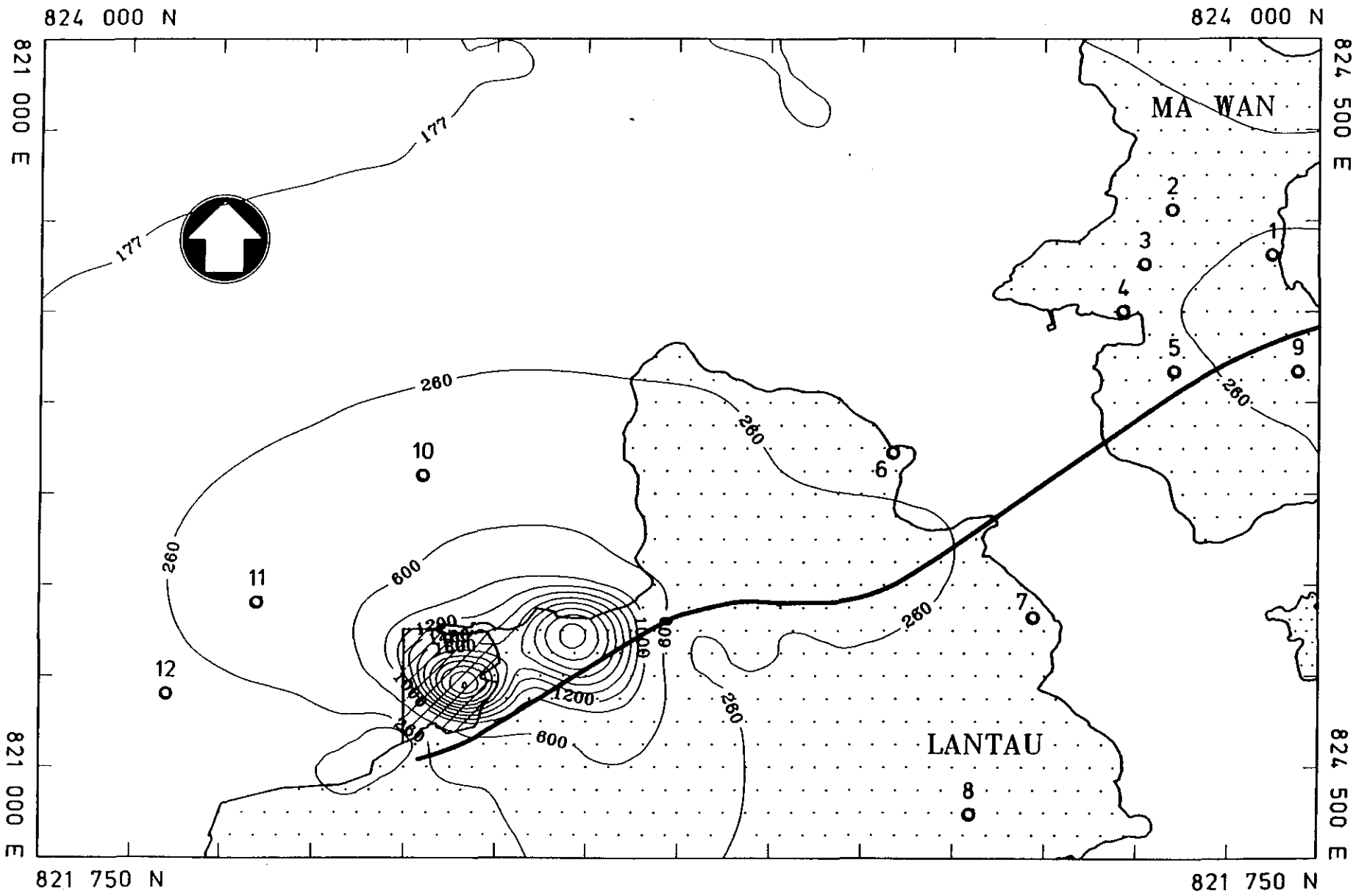
Legend :

- Lantau Fixed Crossing
- Air Sensitive Receiver
- 260 --- Contour Level in $\mu\text{g}/\text{m}^3$

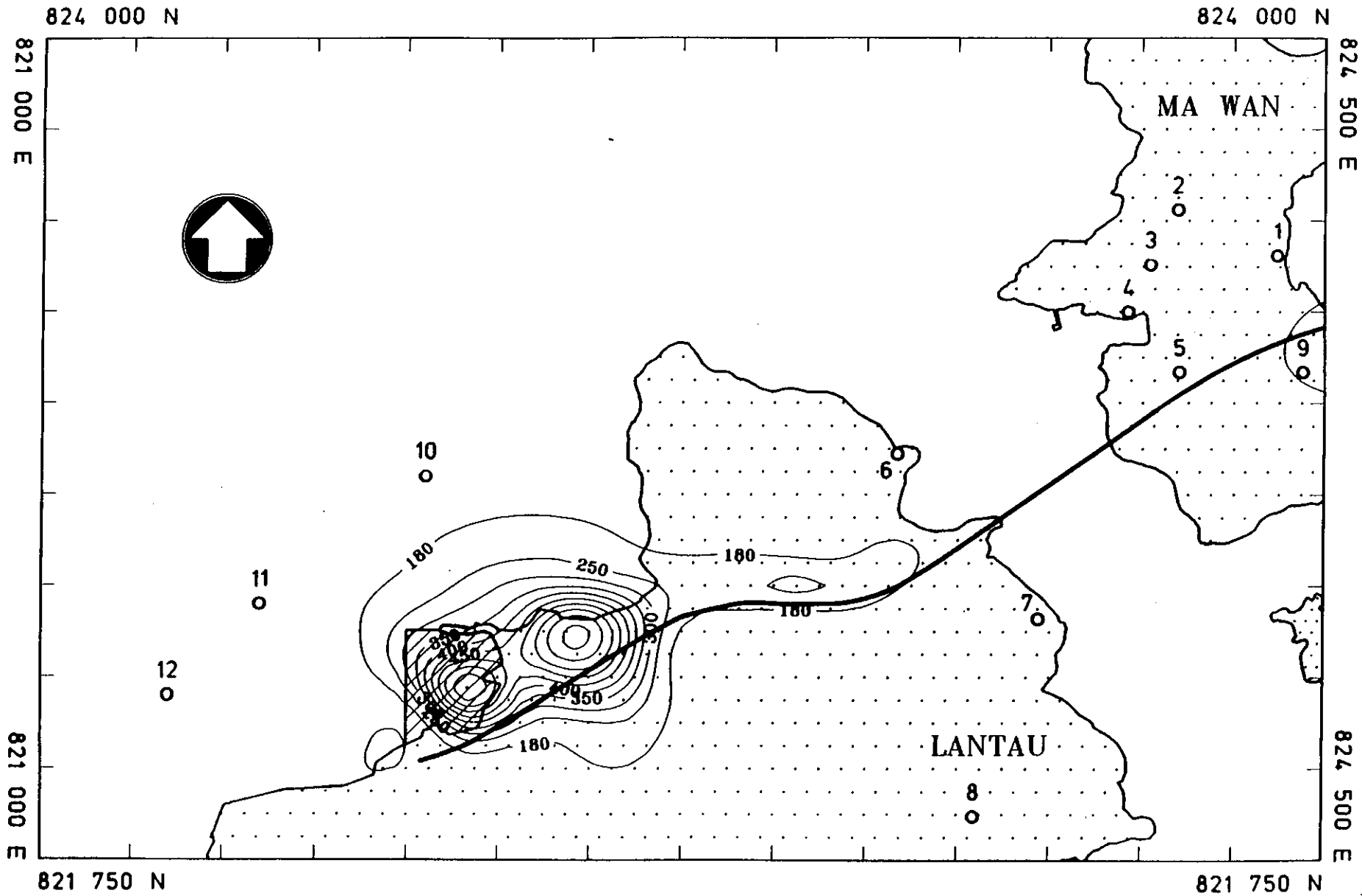

- 821 750 N Coordinates in H.K. Metric Grid
- ▨ Reclamation



24-HOUR AVERAGE RSP DISTRIBUTION DURING PERIOD 3 INCLUDING NLR WITH MITIGATION

FIGURE 2.25

Legend :

-  Lantau Fixed Crossing
-  Air Sensitive Receiver
-  Contour Level in $\mu\text{g}/\text{m}^3$

-  Reclamation
- 821 750 N Coordinates in H.K. Metric Grid

FIGURE 2.26

PREDICTED 24-HOUR TSP CONCENTRATION IN PERIOD 3 INCLUDING NLR

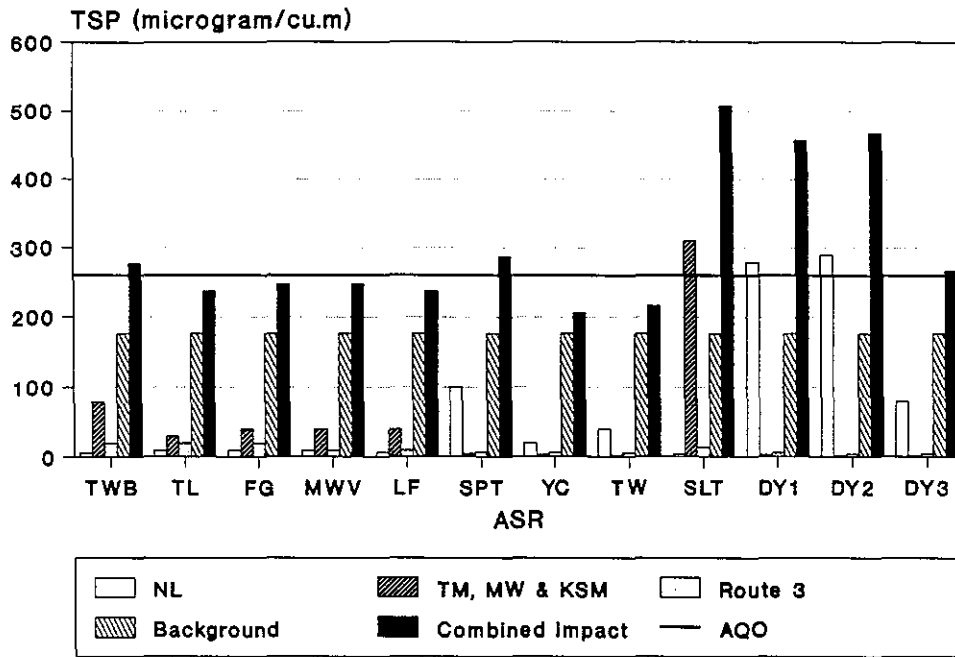
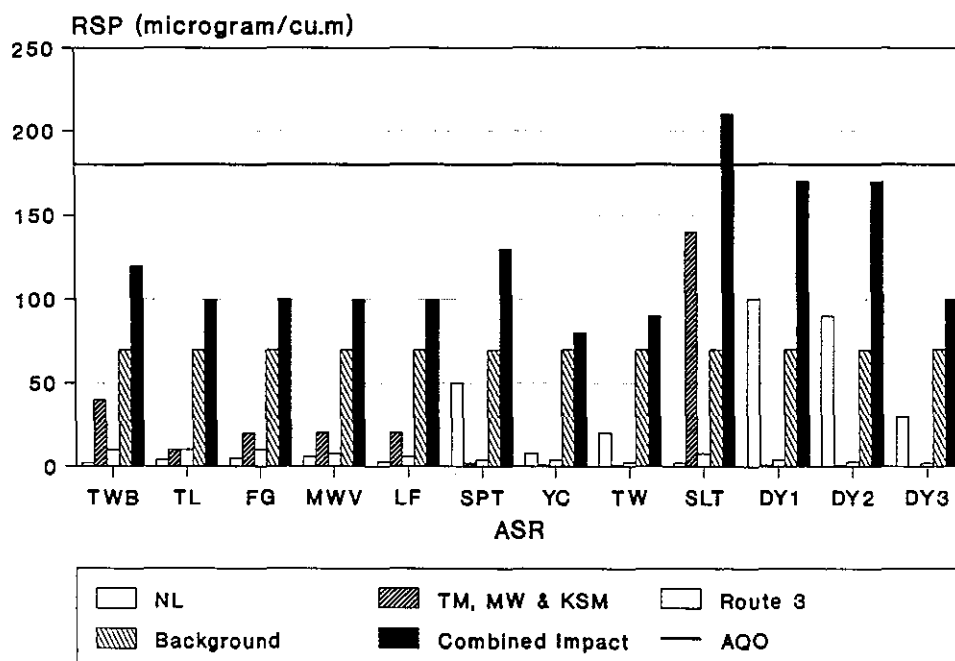

FIGURE 2.27

PREDICTED 24-HOUR RSP CONCENTRATION IN PERIOD 3 INCLUDING NLR



Note: NL - North Lantau Road
 TM - Tsing Ma Bridge
 MW - Ma Wan Viaducts
 KSM - Kap Shui Mun Bridge

FIGURE 2.28

PREDICTED 24-HOUR TSP CONCENTRATION IN PERIOD 3 INCLUDING NLR WITH MITIGATION

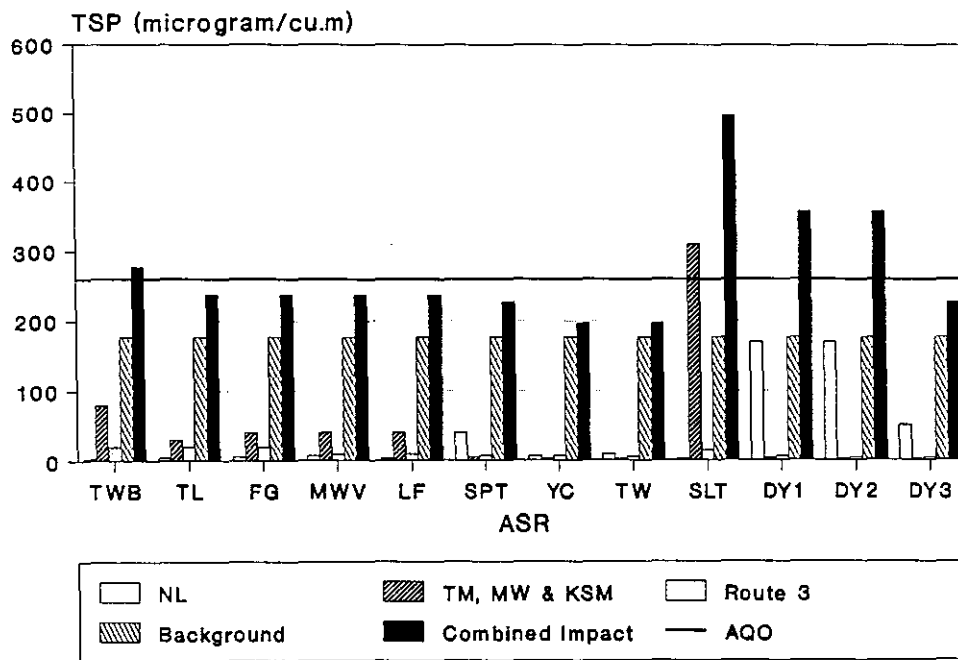
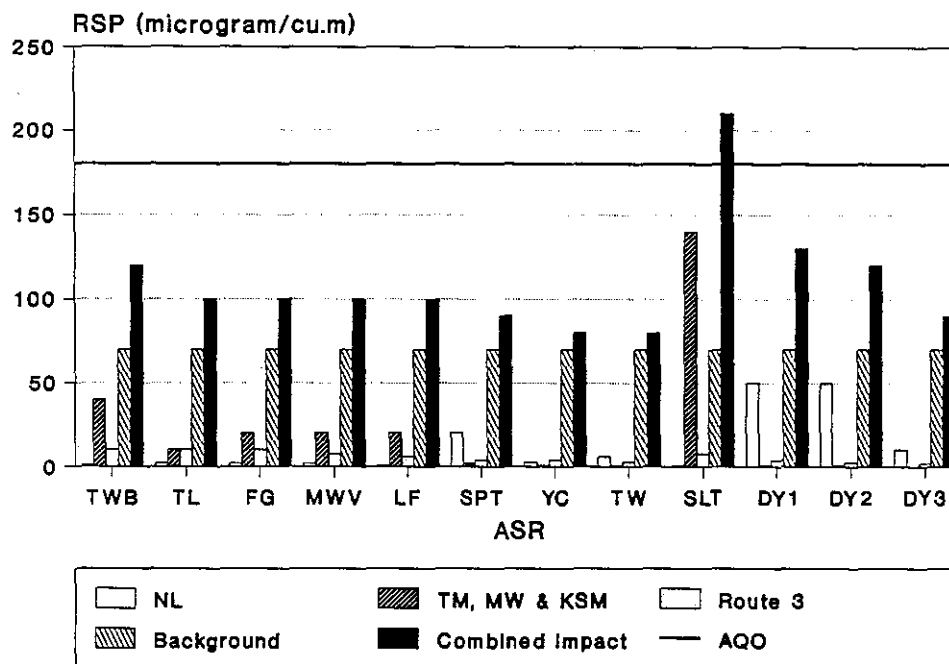

FIGURE 2.29

PREDICTED 24-HOUR RSP CONCENTRATION IN PERIOD 3 INCLUDING NLR WITH MITIGATION



Note: NL- North Lantau Road
 TM - Tsing Ma Bridge
 MW - Ma Wan Viaducts
 KSM - Kap Shui Mun Bridge

FIGURE 2.30

CROSS SECTION OF PREDICTED NO₂ CONCENTRATION DOWNWIND OF THE LFC

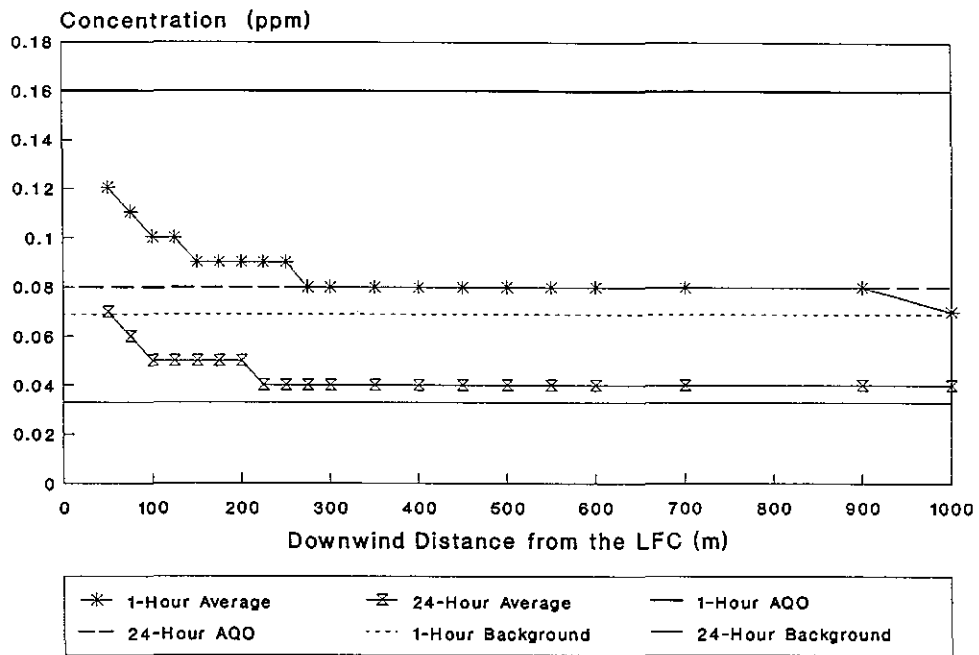

Note: Concentrations include Background

FIGURE 2.31

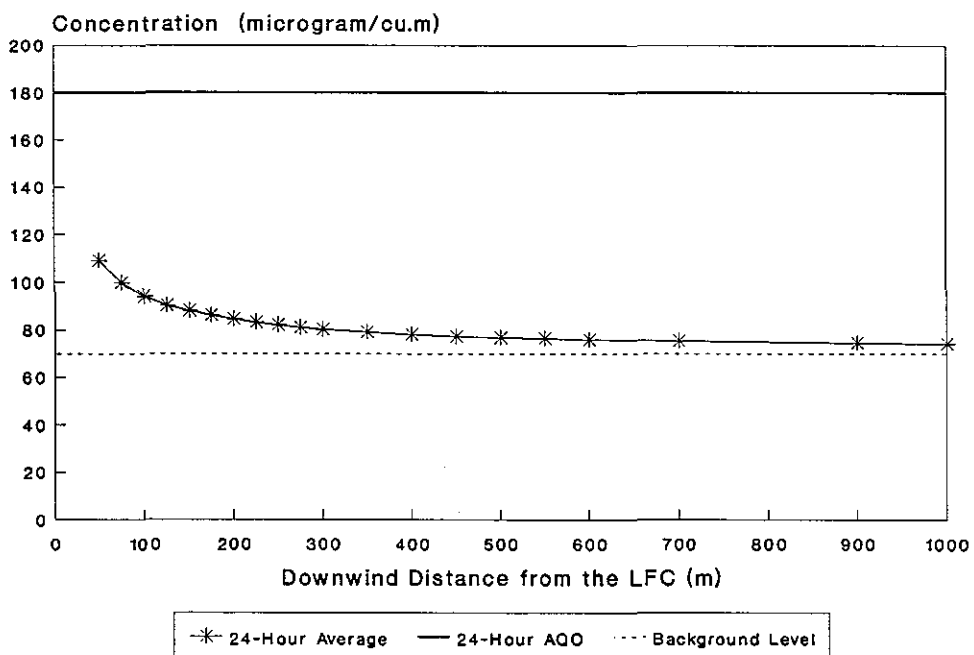

CROSS SECTION OF PREDICTED RSP CONCENTRATION DOWNWIND OF THE LFC

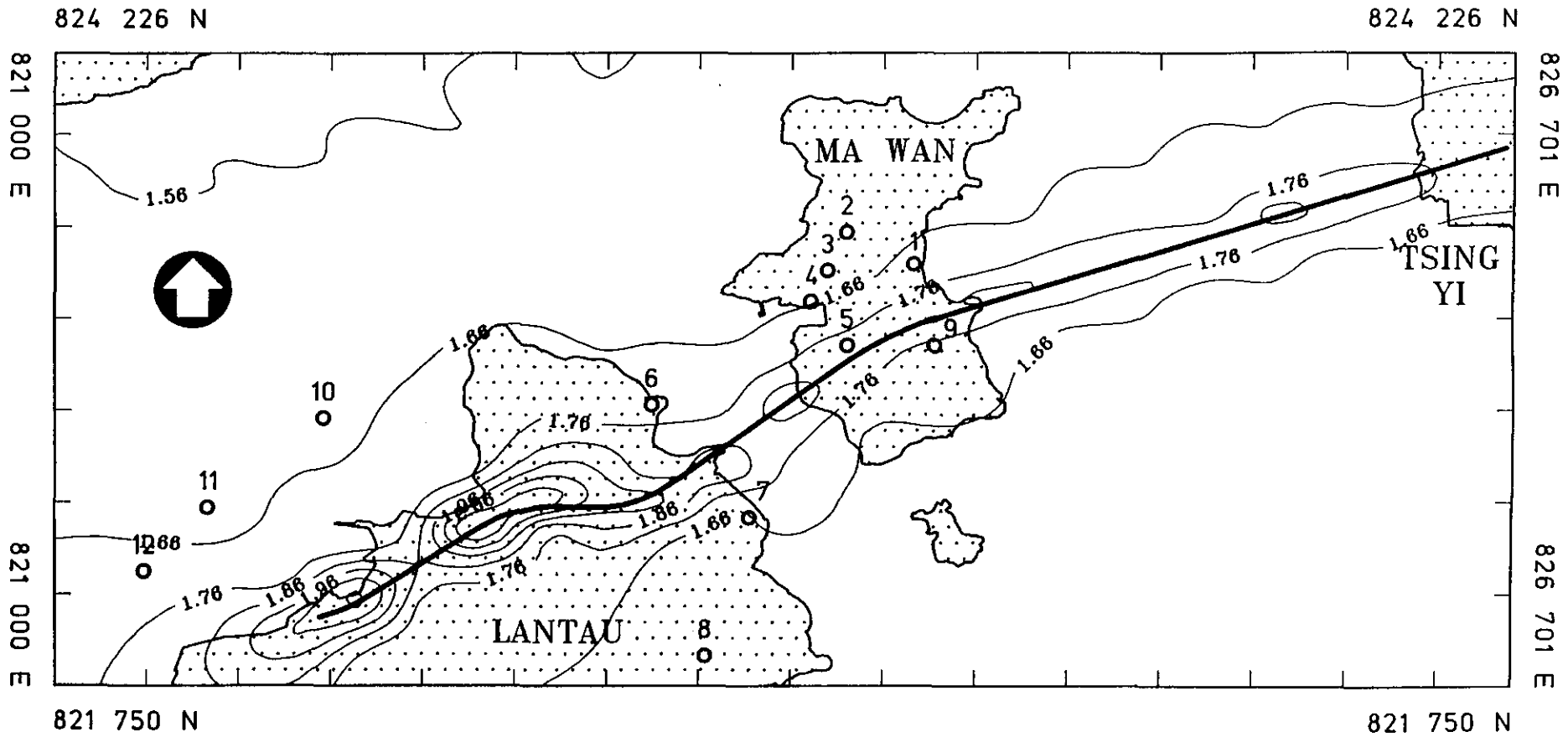

Note: Concentrations include Background



Legend :

-  Lantau Fixed Crossing
-  Air Sensitive Receiver
-  Contour Level in ppm
- 821 750 N Coordinates in H.K. Metric Grid

1-HOUR AVERAGE CO CONCENTRATION DURING OPERATION

FIGURE 2.32

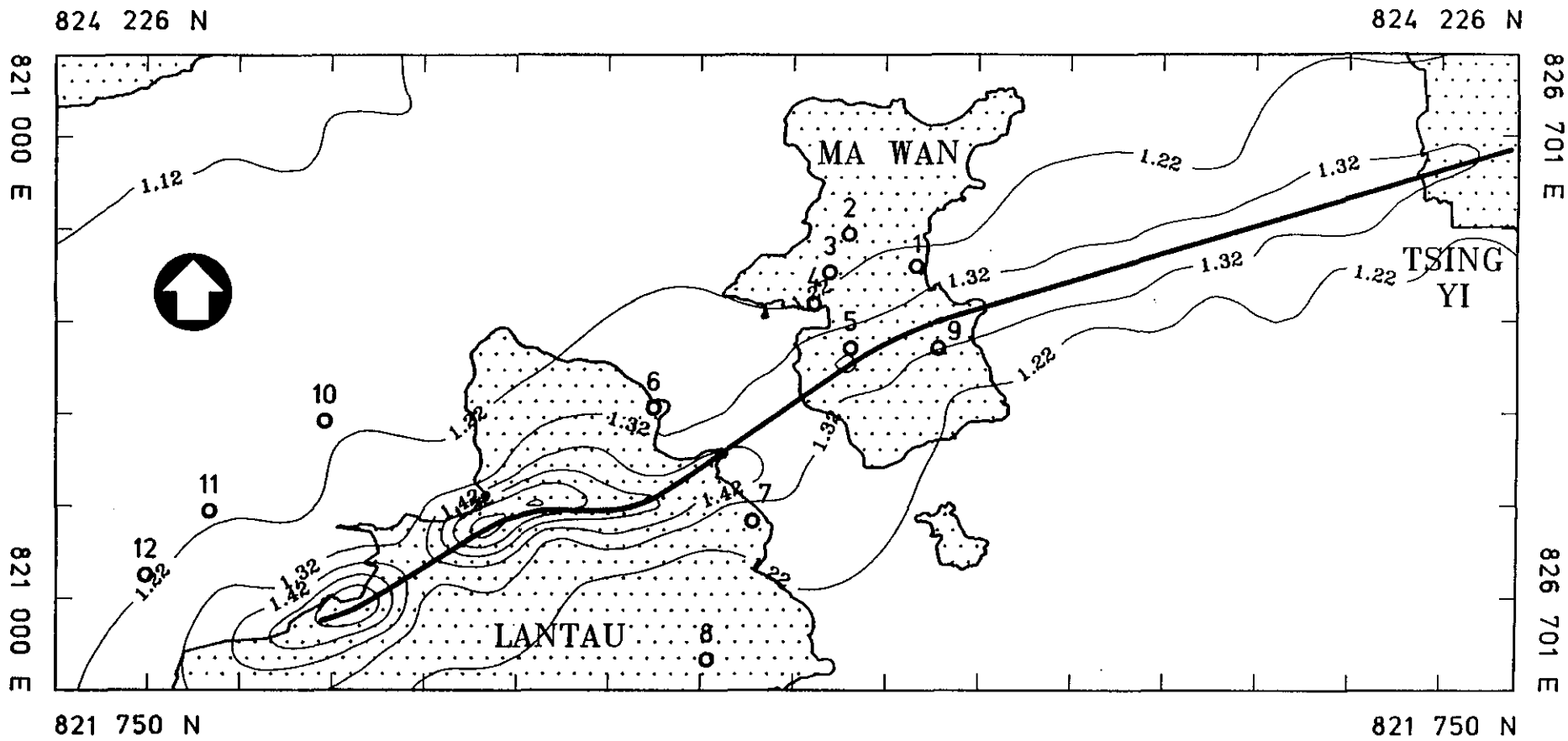

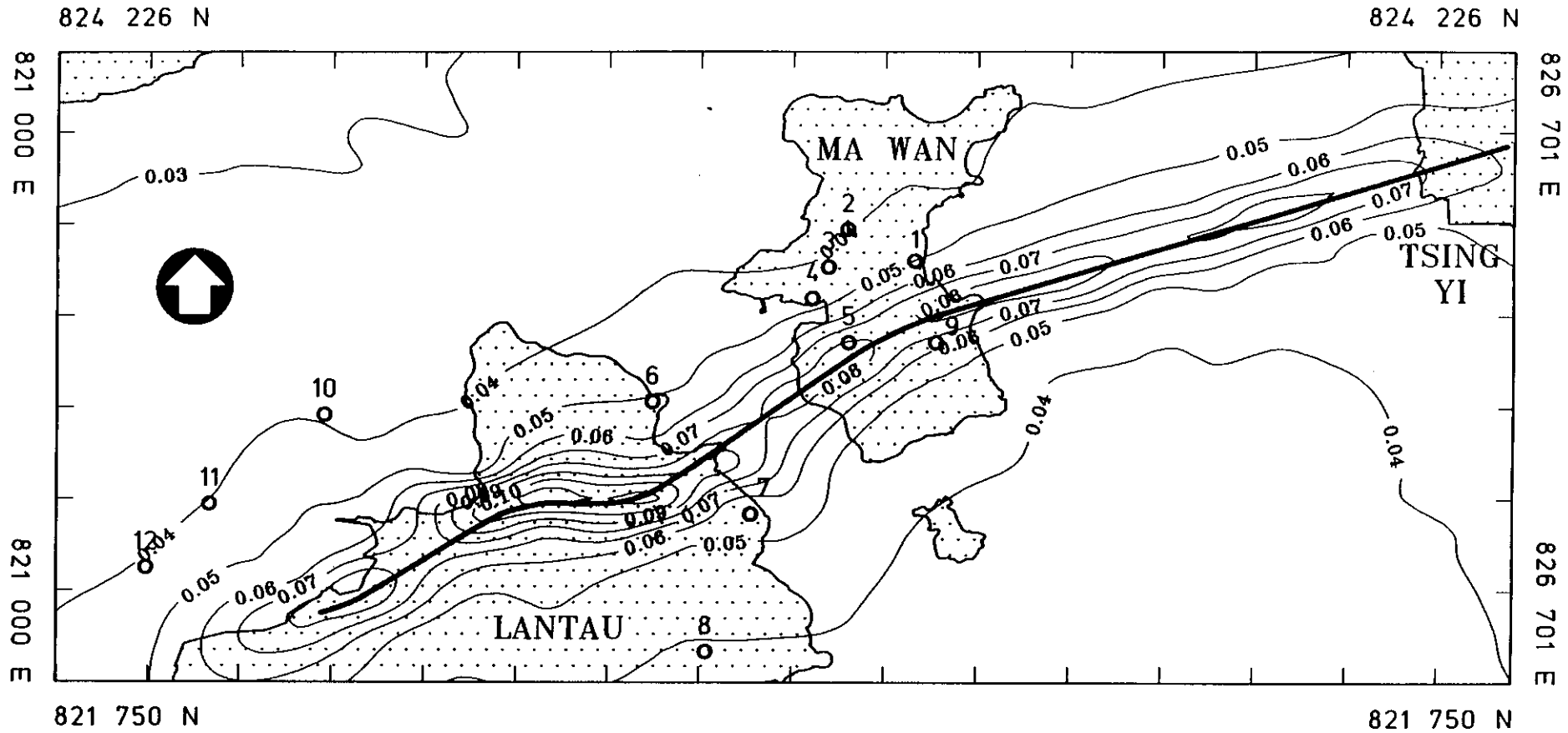

8-HOUR AVERAGE CO CONCENTRATION DURING OPERATION

FIGURE 2.33



Legend :

-  Lantau Fixed Crossing
-  Air Sensitive Receiver
-  Contour Level in ppm
- 821 750 N Coordinates in H.K. Metric Grid

24-HOUR AVERAGE NO₂ CONCENTRATION DURING OPERATION

FIGURE 2.35

3. Water Quality

3. WATER QUALITY

3.1 Background

This assessment is founded on the preliminary work undertaken for the EPA and reported upon in the Lantau Fixed Crossing Environmental Assessment, Topic Report No. 3 - Water Quality. The EPA identified construction activities with the potential to impact on water quality. These included underwater excavation and dredging activities particularly in areas where particulates and sediments could be transported to sensitive receivers. Attention was focused upon the bathing beach at Tung Wan and the Fish Culture Zone at Kung Tsai Wan. Examination of bed deposits in the Tung Wan area and current speeds led to the conclusion that fine sediments released during construction of the western pier of the Tsing Ma Bridge could have an impact on water quality in the bathing areas under certain conditions of wind and tide. Also of concern was the potential impact on water quality from accidentally spilled oil and chemicals which would exert an oxygen demand on the water if they are likely to remain in the area for a long time. It was also concluded that any dredging for the eastern anchorage of the Kap Shui Mun bridge could also have an impact on water quality in the Fish Culture Zone some 200m to the north.

Accidental or uncontrolled discharges from work sites may also adversely affect the quality of the receiving water. Locations of work sites were not defined for the EPA but potential on-site and off-site areas were examined. It was concluded that adequate and appropriate drainage and disposal facilities were required at all work sites particularly if residential facilities are to be provided. All discharges from sites, whether permanent or temporary, would have to comply with the Water Pollution Control Ordinance and its Technical Memoranda.

It was also established that some streams and water courses would require diversion during the construction phase. It was concluded that although the Study Area boasts some interesting habitats, it is unlikely that any areas of special ecological significance would be affected by construction of the LFC.

Impacts on water quality during operation of the LFC are likely to be only of local significance. These include the extension of the embayment at Tung Wan created by the positioning of the western pier of the Tsing Ma Bridge. Accidental spillages from vehicles while traversing the Tsing Ma Bridge could have an impact on water quality at Tung Wan, while spillages from the Kap Shui Mun bridge could affect the Fish Culture Zone at Kung Tsai Wan.

Mitigating measures were proposed in the EPA to protect water quality during both construction and operation phases.

The EPA concluded that certain aspects of the assessment required further examination to confirm that impacts would be acceptable or so that suitable mitigation could be developed. These were:-

- (a) the extension of Tung Wan Bay;
- (b) works sites in the Kap Shui Mun Channel and Penny's Bay;
- (c) underwater blasting;
- (d) disposal of dredged materials;

- (e) conditions to be included in construction contracts to monitor and control water quality; and
- (f) environmental audit.

These are discussed in the following sections.

3.2 Extension of the Tung Wan Embayment

One of the main issues arising from the EPA was the impact on water movement and water quality arising from extending the embayment at Tung Wan by constructing the Tsing Ma Bridge pier and western anchorage at To Tei Kung Kok.

The existing situation in the vicinity of Tung Wan is that nearshore tidal currents in the western part of the Ma Wan Channel are relatively weak and suspended sediments released during construction could be subject to wave induced transport. Such transportation of suspended materials to the beach at Tung Wan is possible under conditions of E-SE winds during slack tides.

Once the LFC is operational, there could be local effects arising from trapping of pollutants in the extended Tung Wan. Sources of pollution may arise from the hinterland behind the bay, from accidental spillages washed off the Tsing Ma bridge or from water exchange with the mainstream water of the Ma Wan Channel. Exchanges between the waters within Tung Wan and the mainstream of the Ma Wan Channel are presently slow and thus retention time of pollutants with the bay may be long. Modelling work undertaken for the Ma Wan Channel Improvement Study indicated that even if the proposed Ma Wan Channel Improvements are carried out, low tidal velocities will still prevail in this area. At present the water quality within Tung Wan is good. The alteration in water movement consequent to construction of the Tsing Ma Bridge could, however, alter this.

A modelling study was recommended in the EPA to assess the impacts on water quality subsequent to the formation of the anchorage and pier protection island. Time constraints precluded setting up a detailed mathematical model in the area and recourse was made to the WAHMO physical model which is located in the Harbour Hydraulic Laboratory at Tuen Mun.

Physical Model Methodology and Results

The WAHMO physical model was used to determine alterations to current speeds and direction. Results of the physical modelling were examined to identify the potential for pollutants to enter the bay during and after construction. Particular emphasis was placed on the water movement patterns both within and immediately outside the bay. From this information an assessment was made of the potential for alteration in water quality after construction of the Tsing Ma Bridge.

The physical model simulates the vertically well mixed dry season situation but the complex stratification pattern of the wet season cannot be realistically represented.

Initially the model was run without any modification to the coastline during both spring and neap tides to provide a baseline. A series of time history plots at predetermined locations were generated as well as float tracks. Velocity vectors were also produced. Following this the coastline was modified to represent the Tsing Ma Bridge and the associated works site to scale.

The reason for simulating both pier and work site was that the work site will be formed as part of the LFC contract and is likely to remain following completion of the works.

The drawing given to CESD, who carried out the modelling exercise, is shown as Figure 3.1. Included on this drawing are the seven locations chosen as monitoring stations for generating time histories. Raw data from the modelling are given at Appendix E. Table 3.1 shows net velocity vectors for stations 1, 4 and 6.

Examination of predicted peak velocities shows that on the spring tide the peak velocity increased at stations 1, 3, 5, 6 and 7 in the scenario test. Within Tung Wan, at Station 2, the peak velocity was little affected. At station 4, north east of the bridge pier the predicted peak velocities were lower in the scenario test.

Table 3.1 Net Velocity Vectors of Stations 1, 4 and 6 On Neap and Spring Tide Cycles at Tung Wan Bay

	Neap Tide				Spring Tide			
	Basecase		Scenario		Basecase		Scenario	
	Direction (°)	Velocity (m/s)	Direction (°)	Velocity (m/s)	Direction (°)	Velocity (m/s)	Direction (°)	Velocity (m/s)
Station 1	348	3.3	006	4.5	0	3.3	004	4.1
Station 4	348	6.5	353	2.3	352	6.3	329	2.6
Station 6	1	5.6	008	4.9	002	6.3	002	6.8

During the neap tide the peak velocities increased at stations 1, 3 and 5 while at stations 2, 6 and 7 only slight differences were noted. As on the spring tide the peak velocities decreased at station 4.

Local water movements are thus, not unexpectedly, affected by the construction of the western pier of the Tsing Ma Bridge. Comparison of the two sets of data (baseline and scenario) indicate a slight shift in tidal phase as well as velocity.

As the peak velocities at stations 1, 3 and 5 all increased when the bridge pier, anchorage and work site were modelled it implies that pollutants may well be transported across the mouth of Tung Wan in a north-south direction. However, there was a certain amount of exchange between the waters within Tung Wan and the mainstream flows, and this could affect water quality in the bay. The velocity vectors plotted out from time-lapse photography of the model simulation have been used to estimate the mixing.

Examination of the velocity vectors shows that for a short period of time, as the flood tide moved water in a generally northerly direction, there was an offshoot which set up a circular movement within Tung Wan. When the tide turned, there was also a small exchange of water between the mainstream and Tung Wan, although the predominant movement was some 500m offshore. Once the anchorage, work site and pier for Tsing Ma Bridge are in place, the model simulations indicated an increase in water exchange. The flow was bifurcated by the pier and there was increased circulation into the bay by the eddy which formed round the pier thus forcing water into Tung Wan.

On the spring tide, similar predictions were made and the scale and magnitude of the eddy formed around the pier was greater than that of the neap tide. Water movements within Tung Wan were encouraged once the pier is in place, and were maintained over the entire tidal cycle.

In conclusion, it is likely there would be increased circulation of water within Tung Wan once the western anchorage, work site and pier of the Tsing Ma Bridge are formed. This circulation should be enhanced during the wet season. Water exchange rates between Tung Wan and the mainstream are also likely to increase. The impact this would have on water quality is dependent upon the quality of the inflow waters. However, retention time of pollutants within, the bay should be slightly reduced and it is probable that water quality may not suffer a decline but rather may improve once the LFC is operational.

The changes in water movements would, of course, be progressive over the construction of the pier and anchorage reclamations and the works site. The EPA concluded that sediment spilled during construction could move towards the bathing beach and affect water quality, at least visually. The present modelling does not change this conclusion. This, however, will be over a short period of time and the total amount of sediment deposited will be small. The impact on the beach itself will be minimal but there could be some discolouration of the water during the dredging. This would not cause a health hazard. The changes in water movements are not large enough to cause any significant changes in the beach profiles.

In addition, there may be safety implications in having a public bathing beach close to a major construction site. Consideration should be given to restricting use of the beach, or even closing it, during the construction for the safety of the public.

3.3 Penny's Bay Works Site

Penny's Bay has been identified as a possible location for the fabrication and storage of units for the Tsing Ma and Kap Shui Mun Bridges. The reclamation of land to provide a work site at the western entrance to Penny's Bay could affect local water movements and water quality. The WAMHO physical model was used to assess alterations to water movements and the results were used to evaluate possible changes in water quality.

Initially, the model was set up to simulate existing (basecase) conditions in the area immediately adjacent to and within Penny's Bay. Time history plots for current speed and direction were obtained at seven locations as shown on Figure 3.2. Velocity vectors were also plotted, from time-lapse photography, at two hourly intervals. The raw data are included as Appendix F.

For the scenario test, the model geometry was modified to represent, to scale, the maximum area available for the proposed work site, also shown on Figure 3.2. Model output comprised time history plots for the seven locations previously chosen for the basecase, in addition to velocity vectors. Dry season spring and neap tides were simulated for both the existing situation and the scenario test.

Examination of the model results shows that in the inner part of Penny's Bay (stations 1, 2 and 3) existing water movements were very slow. Peak velocities for neap and spring tides were less than 0.1m/s, with mean velocities of the order of 0.03m/s. At the mouth of the bay (stations 5, 6 and 7) peak velocities were between 0.2 and 0.3m/s with mean velocities of between 0.1 and 0.2m/s.

A comparison of the results of the scenario test with the basecase shows the reclamation had little impact on velocities in the inner bay, during either spring or neap tide. At station 3 a slight increase in peak velocity was predicted on the spring tide, with an overall decline in velocities during the neap tide. A reduction in velocity over both tidal cycles was shown at nearby station 4. At the mouth of Penny's Bay (station 5), predicted peak velocities increased from 0.15m/s to 0.22m/s during the first part of the spring tide; an alteration in the phasing of the neap tidal cycle was also predicted. At station 6 velocities were generally higher over the spring tidal cycle. At station 7, velocities increased during the spring tide and during the first part of the neap tide. A jetty may be built off the southern face of the reclamation, for transfer of materials to and from the work site and it is thus important to review any increases in velocity which could affect vessel movements. On the basis of the model results obtained, it appears unlikely that any problems, in terms of vessel handling, would arise should a jetty be located in this vicinity.

Interpretation of velocity vectors gave an indication of water movements within Penny's Bay. Results for the basecase show that at the beginning of a spring tide water moved about 1km into Penny's Bay in a semi-circular motion. In the outer part of the bay, as the flood tide progresses, an eddy formed which became stronger towards low high water when a second, but smaller, circulation formed in the inner part of the Bay. Two hours after high water only a small circulation pattern remained in the middle of the Bay although this eddy enlarged and extended outwards for the remainder of the tide. During the neap tide the predominant circulation patterns formed in the outer part of Penny's Bay with a smaller eddy being established in the inner Bay. At high tide the main circulation pattern extended well into the bay (about 1.5km). Once the tide turned the eddy diminished in size.

Formation of the work site could reduce the entrance to Penny's Bay by up to 50%. The model predictions indicate that circulation patterns would be established during the spring tide between the western face of the reclamation and the existing eastern coastline as well as within inner Penny's Bay. Some improvement in water circulation within the inner part of the bay may therefore be expected. On the neap tide the model shows a small circulation of water between the reclamation and the eastern coastline, similar to the spring tide conditions. Extremely weak water movements are, however, predicted in the inner part of the bay with correspondingly low velocities.

Some general observations relating to water quality may be made on the basis of the results of water movement modelling. Even if the entrance to Penny's Bay is reduced, water within the bay would be exchanged with mainstream flows. Pollutants entering Penny's Bay, and especially the inner part of the Bay, could however be retained for a long period of time, and may exert an oxygen demand on the receiving waters. The extent of the impact on water quality would depend upon the nature and quantity of the pollutant, the state of the tide and the location of the discharge. On the basis of the model results the

worst case, for water quality, would be for pollutants to be released in the inner part of the bay on a neap tide and in the dry season.

Once operational, discharges from the work site to the marine environment will be controlled by the Water Pollutant Control Ordinance and specifically Section 21 - 'Technical Memorandum on Effluent Standards' (TM). The TM provides for domestic effluent as well as other discharges. Pretreatment of domestic effluent may be required, depending upon flows and pollutant loads, prior to discharge to the marine environment. It is recommended that domestic effluent be discharged off the southern face of the reclamation rather than within Penny's Bay. Accidental spillages and other possible discharges to the marine environment will be determined by on-site activities which are not fully defined at present. A spill action plan is recommended covering all potential discharges from the work site which could affect receiving water quality. This would need to be developed by the contractor and agreed by the Engineer as its scope will depend on the contractor's activities.

The reclamation in Penny's Bay is therefore unlikely to have an unacceptable impact on water quality. Discharges from activities on the reclamation should be controlled by the TM and therefore should not cause unacceptable water quality impacts. The contractor's activities should be monitored to ensure that the provisions of the TM are complied with and that care is taken to avoid spillages.

3.4 Kap Shui Mun Works Sites

In addition to physical model runs on the Tsing Ma Bridge and its associated work site, further model tests were run to assess the likely impacts on water quality from the construction of the Kap Shui Mun Bridge.

The construction of Kap Shui Mun Bridge will involve the reclamation on Ma Wan, North of Lung Ha Wan and the bay between Tai Chuen and San Po Tsui on North Lantau side. (Figure 3.3).

The main concerns are the impact on the Fish Culture Zone at Kung Tsai Wan resulting from changes in water current and directions after the reclamation and the accidental release of oils, chemicals and other polluting materials from the two work sites.

Raw data on the model results are presented in Appendix G. The model runs were based on the cases without reclamations (basecase) and with reclamations (scenario).

Results for dry season neap and spring tides show marked changes in stations, 1, 3 and 7 but water movements were relatively unchanged at stations 2, 4, 5 and 6.

The stations which were predicted to have little impact were located in the middle of the Kap Shui Mun Channel where strong tidal currents exist. The changes in water current speeds and directions induced by the reclamation were relatively small compared with the strong tidal influence.

Station 1 was located at Tung Tsai Wan at which a Fish Culture Zone is situated. During the neap tide flood period, the current speeds were reduced by approximately 10%. On the flood period, the current speeds remained more or less the same. In both periods the current directions deviated considerably when compared with the basecase. During spring flood tides, the current speeds reduced significantly by more than 50% and could reach nil speed.

Station 3 was in the vicinity of the work site on North Lantau. The sea wall was at an angle to the main tidal flow and hence the modelling showed relatively slow speeds and the formation of an eddy after the reclamation. During neap flood tides, the current speeds increase by more than 25% compared with those in the ebb tide. The current directions predominantly flowed from the NW direction which was a shift of some 25° compared with the basecase. On spring tides, current speeds generally increased and a shift in current directions was predicted.

Station 7 is south of the Lung Ha Wan Work Site. The current speeds in neap tides reduced and the current directions were within the range of 270° and 360° which again was a change from the current directions in the basecase. On spring tides, there was a shift in speed and direction. The speed on average reduced by 20%.

Further analysis of the time history plots of Stations 1, 3 and 7 during neap and spring tides has been made by summing up the velocity vectors during the tidal cycles. The net changes in water quality in the stations were then predicted. Table 3.1 shows the net velocity vectors at the stations 1, 3 and 7.

Table 3.2 Net Velocity Vectors of Stations 1, 3 and 7 On Neap and Spring Tide Cycles at Kap Shui Mun

	Neap Tide				Spring Tide			
	Basecase		Scenario		Basecase		Scenario	
	Direction (°)	Velocity (ms ⁻¹)	Direction (°)	Velocity (ms ⁻¹)	Direction (°)	Velocity (ms ⁻¹)	Direction (°)	Velocity (ms ⁻¹)
Station 1	256	0.4	221	1.4	302	2.2	328	1.0
Station 3	137	3.3	120	5.9	143	4.4	114	5.3
Station 7	258	0.7	286	2.0	273	0.5	265	1.7

The current speeds will increase significantly at Station 3 and 7 with the reclamations in place and the net current directions are away from the bay. This means that if there is any accidental spillage from the work sites, the pollutants would be transported away from the works site and would be dispersed by the main tidal flow in the Kap Shui Mun Channel.

At Station 1, water quality would not deteriorate during neap tides as the current speeds increase significantly and the net current flow is 221° which will flush pollutants out of the bay. However, the Fish Culture Zone in the bay could suffer from increased pollution during spring tides. The net current velocity would reduce from 2.2ms⁻¹ to 1.0ms⁻¹ and the net flow is away from the bay. Hence any accidental spillages from the work site and the pollution associated with the mariculture itself will tend to be carried away into main tidal current.

3.5 Underwater Blasting

The Environmental Planning Assessment identified underwater blasting as one issue that needed further consideration as there could be impacts on the Fish Culture Zones at Kung Tsai Wan on Ma Wan from excavation in the Kap Shui Mun Channel or on the north of Ma Wan. However there would be no impact from the works for the Tsing Ma Bridge as the possible blasting sites (the excavation for the piers and anchorages) are on the south east of Ma Wan and are therefore remote from the Fish Culture Zones. It is therefore concluded that this issue does not need to be considered further for the Tsing Ma Bridge.

Impacts from works for the Kap Shui Mun Bridge would need to be considered as part of the environmental assessment to be carried out by the contractor if any underwater blasting is required.

3.6 Disposal of Dredged Materials

Only a very small amount of dredging would be needed for the project as presently designed and no special provisions for disposal of this material are needed. It is recommended that disposal should be at a gazetted dumping ground subject to the contractor obtaining the necessary licenses.

There could be larger quantities of dredged marine mud from the reclamation at Penny's Bay, should this be included in the project. This area has been allocated to the project as a possible works site, but the need for reclaiming the area cannot be confirmed until the contractor's method of working is known. The works site would probably be used for fabrication of the steel deck sections and it is more than likely that a contractor would prefer to fabricate the sections elsewhere in which case the Penny's Bay works site would not be needed for this project.

The design for the reclamation in Penny's Bay, and therefore the quantity of marine mud, cannot be confirmed until the use by the contractor and the after-use are known. The latter will not be available until the development of the Penny's Bay area has been considered by the Port Peninsula Study. The reclamation design should avoid mud dredging if possible. Any mud which does have to be dredged could be dumped at the dumping ground at Cheung Chau or backfill marine borrow areas, perhaps at North Lantau.

3.7 Monitoring during Construction

The EPA included consideration of monitoring during construction and water quality standards to be applied. These have been reviewed following comments from EPD and the results of the modelling and the following target levels have been recommended:

- (a) Dissolved Oxygen - a minimum of 5 mg/l in the surface layer and 2mg/l in the bottom layer at all monitoring sites.
- (b) Turbidity - a maximum increase of 30% above ambient levels at all monitoring sites more than 100m from any dredger used for the Works.
- (c) Suspended Solids - a maximum of 100mg/l at a radius of 100m from any dredger used for the Works, and a maximum of 30% above ambient levels at monitoring sites more than 100m from the site.

Baseline monitoring should be carried out in the period immediately prior to the start of the work and it has been recommended that the construction contract includes clauses allowing the standards to be modified if appropriate.

Monitoring of water quality has been recommended at the seven stations used in the physical modelling. In addition a monitoring station has been recommended in the channel between Ma Wan and Tang Lung.

Further monitoring will be needed for the Kap Shui Mun Bridge and Ma Wan Viaducts construction. The scope of this may be determined following submission of the contractors environmental assessment. Monitoring in Penny's Bay will also be necessary if the reclamation is formed. Monitoring during construction should be at stations 2, 4 and 6 and the results used to check sediment pollution from the works. It would probably not be necessary to continue monitoring after construction of the reclamation but this may be reviewed once details of the use of the works site are known.

The contracts for construction of the LFC include comprehensive provisions for collection of monitoring data. These will need to be developed into a monitoring programme and target, trigger and action levels together with responses to be taken on exceedance of any of these. It has been proposed that this should be done in an operating manual for the Engineer. Many details in the operating manual (including the final details of a monitoring and audit programme) cannot be confirmed until tenders have been received and until methods of construction and construction programmes are known.

3.8 Environmental Audit

It has been concluded that the Tsing Ma Bridge is not likely to have major water quality impacts either locally or further afield. Any permanent impacts would result from the marine works, such as the pier foundations and ship protection, and all these would be completed early in the contract period. It should therefore be possible to complete an audit of the impacts during the construction period by assessing the impact monitoring data. Temporary impacts would be from spills from works sites and it should also be possible to assess these by evaluating the compliance monitoring data. Some four years of compliance monitoring data would be available by completion of construction.

It should not be necessary to carry out any further audit for water quality unless the compliance monitoring data show that significant water quality impacts are continuing.

Audit should not be necessary in the Kap Shui Mun channel or at Penny's Bay for the same reasons.

FIGURE 3.1
TSING MA BRIDGE MA WAN WORKS SITE

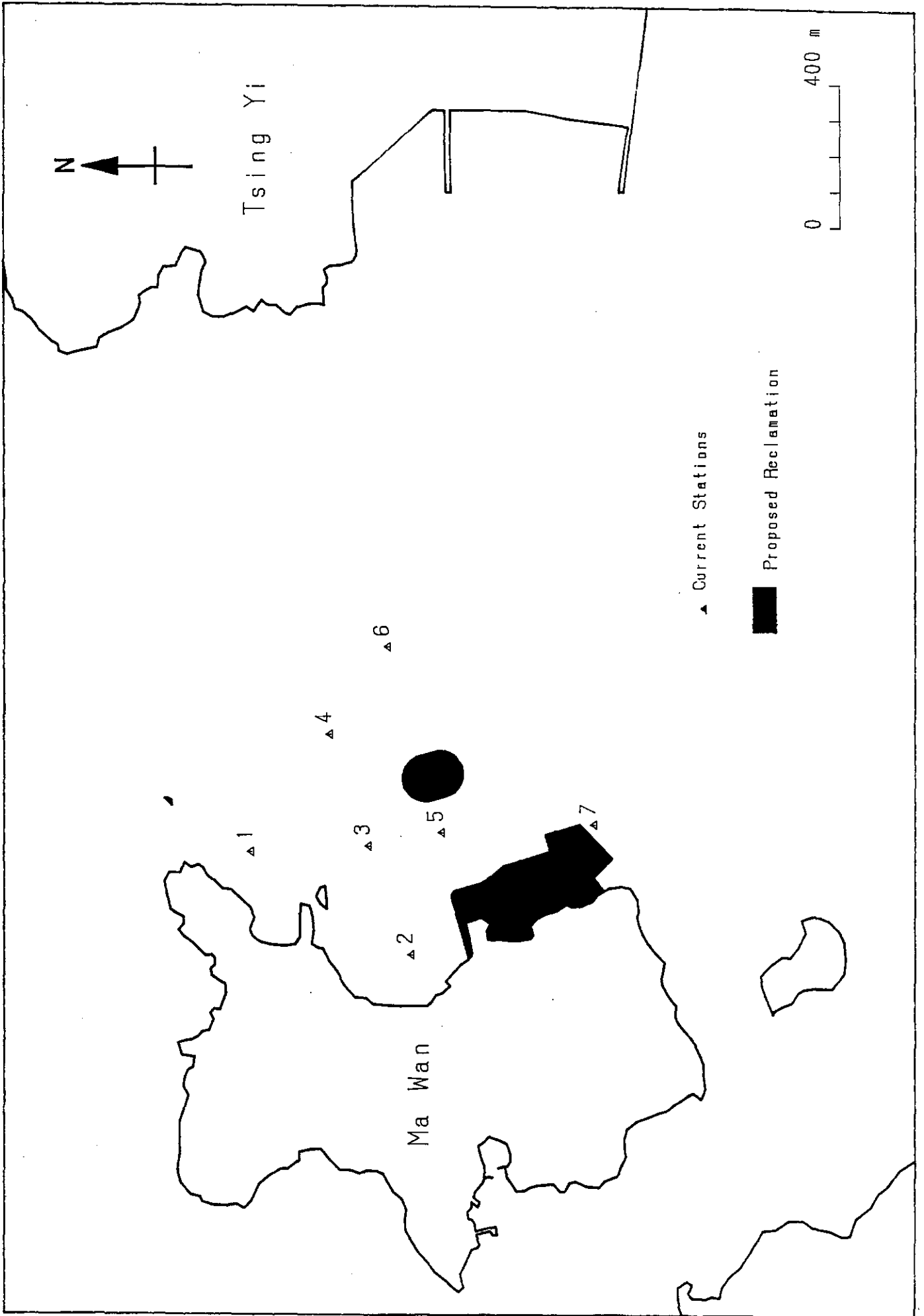

FIGURE 3.2
PENNY'S BAY WORKS SITE

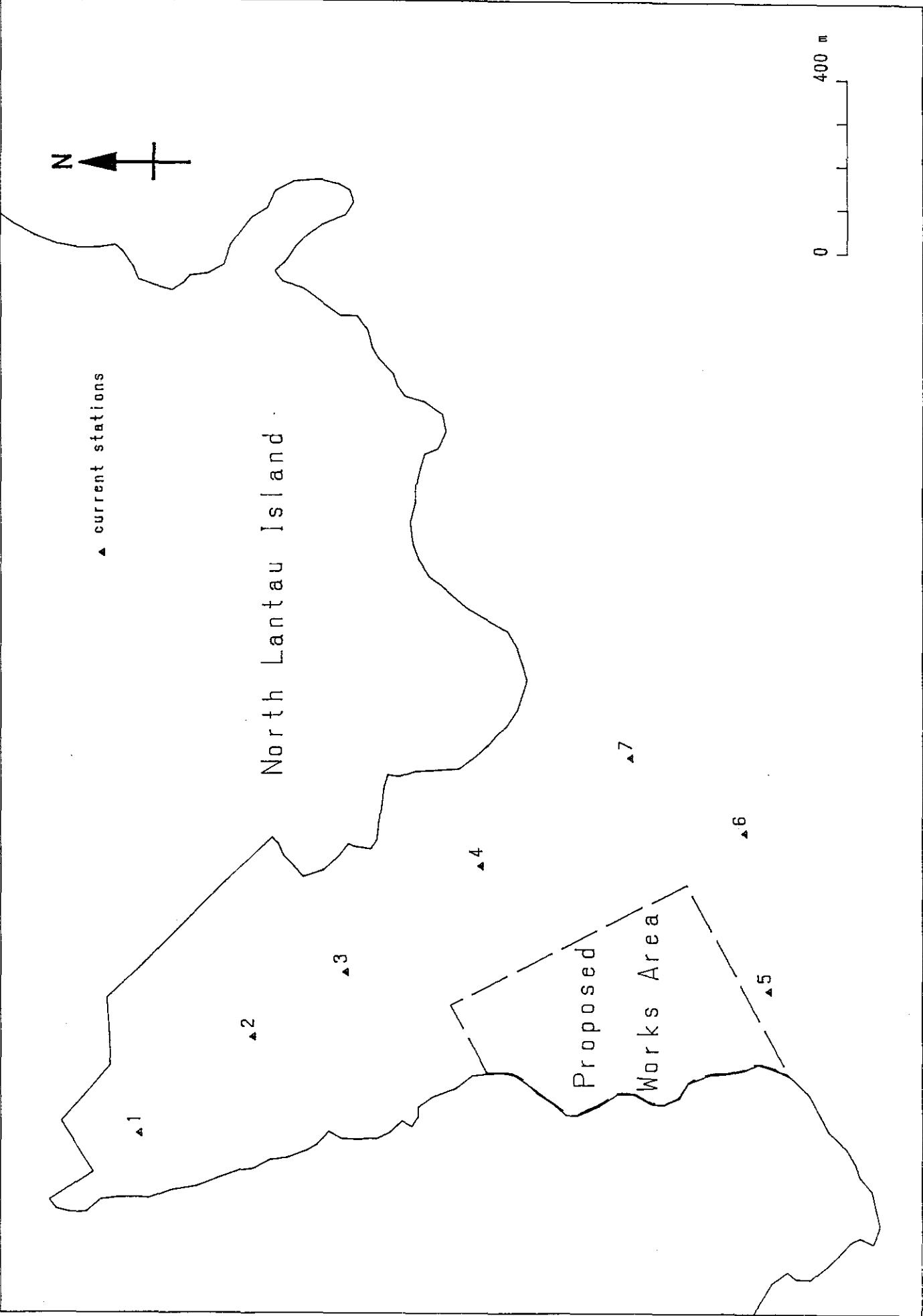
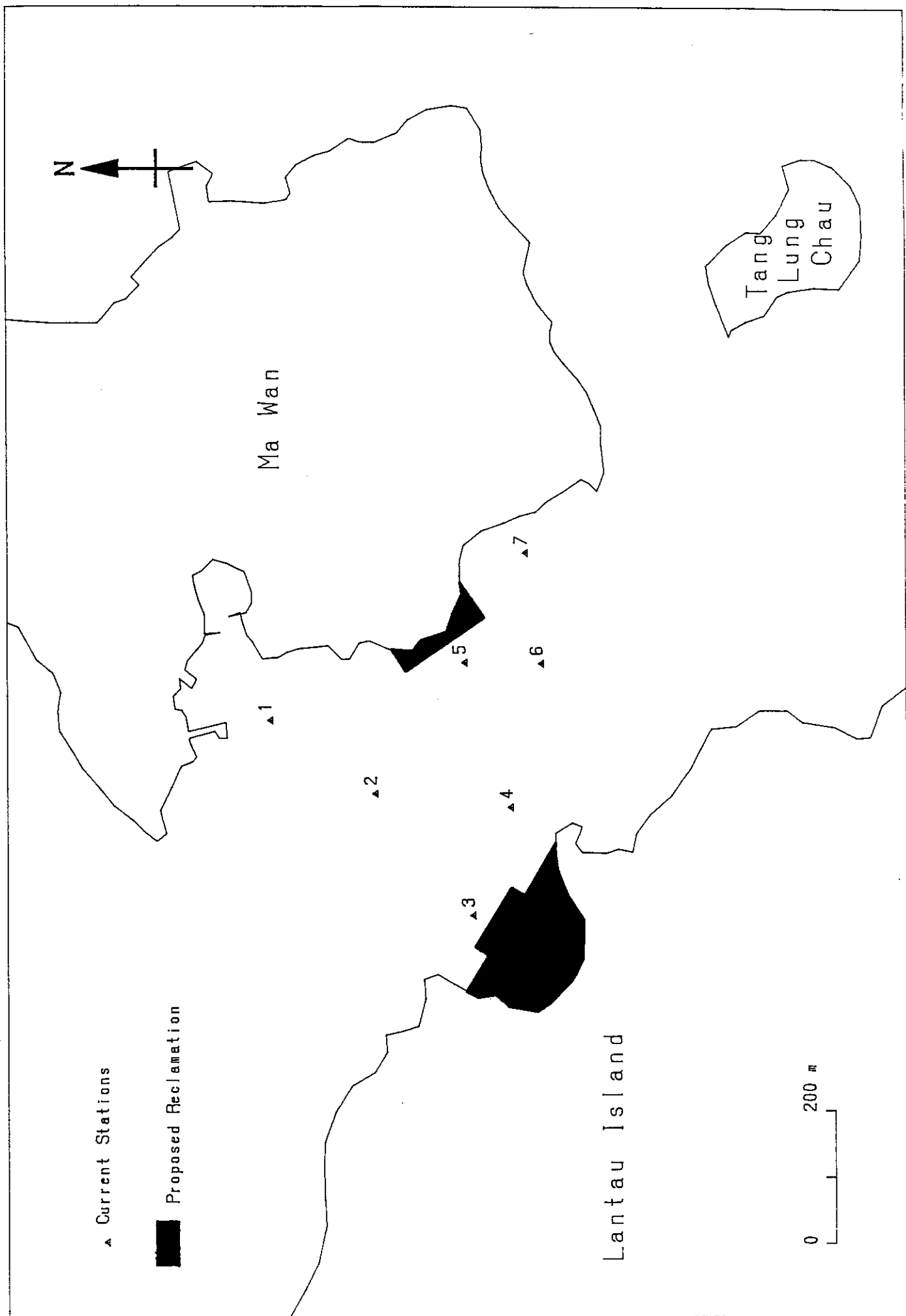

FIGURE 3.3
KAP SHUI MUN CHANNEL WORKS SITE



4. Construction Noise

4. CONSTRUCTION NOISE

4.1 Introduction

The Lantau Fixed Crossing (LFC) is a critical element leading to the opening of the New Airport at Chek Lap Kok and the development of North Lantau. A tight timescale has been set for its construction and it is essential that contractors have flexibility to work 24 hours per day to meet the contract completion dates. It is essential that these dates are met as the LFC will provide the only land access to the New Airport. A delay in the opening of the LFC would therefore result in a delay to opening of the New Airport. In addition some activities in a project of this scale and complexity can only be carried out effectively if continuous working is allowed. Working 24 hours means that there will be noise from construction activities during the night-time and other restricted periods.

Noise from construction activities is controlled under the Noise Control Ordinance (NCO). Contractors who wish to use powered mechanical equipment in the restricted hours (that is any period outside 0700 to 1900 on normal weekdays) apply for a Construction Noise Permit (CNP). This will be granted by the Noise Control Authority (Director of Environmental Protection) if prescribed noise levels (the Acceptable Noise Level) at the nearest sensitive receiver are not exceeded. The noise levels and the method of application are set out in the Technical Memorandum on Noise from Construction Work other than Percussive Piling (TM). A CNP will not be issued in this way if the noise levels are predicted to exceed those prescribed in the TM. The TM makes allowance for this for construction work having important social implications and a CNP may be issued on the advice of the Secretary (SPEL) with higher noise levels.

An alternative approach is available under Section 35 of the NCO whereby Exco exemption from the NCO may be requested. This approach has certain advantages and it has been agreed that Exco exemption will be requested for the LFC.

The purpose of this report is to present the data necessary to support the Exco application. The report includes a detailed assessment of the construction noise from powered mechanical equipment. The report considers the Tsing Ma Bridge (LFC Contract 1) and the Kap Shui Mun Bridge and Ma Wan Viaducts (LFC Contract 2).

4.2 The Exco Exemption

It has been assumed that the Exco exemption (assuming that the application is approved) will allow the contractors exemption from the provisions of the NCO relating to construction noise during the period of the construction contract. It is anticipated that the exemption will be subject to conditions which will be included in the construction contracts. This will allow the conditions to be enforced by Government through the construction contracts. Draft provisions for inclusion in the construction contracts, including monitoring and audit, have been submitted under separate cover.

It is anticipated that the contract conditions will include, inter alia, maximum noise levels from powered mechanical equipment working on the construction works for the periods defined in Section 6 of the NCO. These will be in the form of the maximum noise levels from all construction plant working on the site at any one time. It should be noted that the TM referred to above only controls the use of powered mechanical equipment and separate regulations control noise from percussive piling. It has been assumed that the Exco exemption will not include percussive piling.

The Exco exemption should also cover mitigation of noise at receivers where this is considered to be appropriate. This is discussed further below.

4.3 Methodology

Standard procedures exist for the assessment of construction noise. These are detailed in the TM and in BS 5228 'Noise Control on Construction and Open Sites'. The procedure in the TM has been adopted wherever possible but reference has been made to BS 5228 for situations not covered by the TM (mainly for sound power levels for construction equipment not included in the TM).

The process used for the noise assessment is broadly as follows:-

- (a) a schedule of key construction activities and their duration and programme has been developed based on an analysis of a possible method of working and construction programme. The schedule has been designed to describe only those activities which will generate significant noise and it is therefore not a complete construction programme for the project. There is no information on which activities would need to be carried out in restricted periods and which activities would only be carried out in the daytime. All activities have therefore been taken as night-time and daytime and the noise calculated applies equally to both periods;
- (b) an assessment has been made of the powered mechanical equipment needed for each key activity;
- (c) sound power levels have been allotted to each item of powered mechanical equipment based on the TM and BS 5228 and the total sound power level for the activity calculated;
- (d) the noise at each receiver from each activity has then been calculated and the worst case identified. An allowance has been made for attenuation due to distance and natural barriers and for acoustic reflections;

Steps (a) to (d) give the worst case for noise at the receivers due to the assumed method. It should be noted that a number of assumptions have been made in arriving at these noise levels and contractors may prefer a different method of working and programme to that assumed. The Kap Shui Mun Bridge and the Ma Wan Viaducts could be a different design to that assumed and this adds to the uncertainty. No two contractors will approach the project in the same way but an attempt has been made to estimate a reasonably severe case.

The next stage has been to consider mitigation by breaking down the estimated noise impacts into their components. Possible methods of noise mitigation include the following:-

(a) Silencing plant at source

Mobile plant may be silenced by fitting more efficient intake and exhaust silencers, acoustically dampened panels and covers to engine units, etc. Specially silenced compressors and generators are readily available on the market and therefore could be used instead of the standard types. Electric-powered equipment could be used where applicable instead of diesel-powered or pneumatic-powered equipment. According to the BS 5228 : Part 1 : 1984, the sound reduction that could be achieved by these measures is in the order of 5-10 dB(A). Clauses stating that the most effective silencers and other sound reduction must be applied to all plant likely to be used for 24 hour work will be included in the construction contract.

(b) Erecting noise enclosures around noisy plant

Pneumatic concrete breakers, rock drills and tools are mobile items of plant which are difficult to silence. Acoustic screens could be used to reduce noise emissions but there may be difficulties in moving the screens as the source moves. Total enclosure is possible for stationary equipment items. As much as 20 dB(A) noise reduction may be achieved using a properly designed machine enclosure.

(c) Reducing the number of equipment items;

Halving the number of equipment items could reduce the overall noise level by 3 dB(A). This may not be practical for all activities and has not been included as an option in calculating the noise levels.

(d) Enclosing the tunnel portal with acoustic screens

Tunnel portals are stationary noise sources and it is common to enclose the portal with a noise enclosure to reduce noise leakage from tunnelling activities. However it is not considered that this will be necessary in this case as the tunnel will commence at the bottom of a deep excavation which will have high vertical sides. The sides of the excavation will effectively screen the tunnel noise. However it has been assumed that screens will cover spoil chutes and a stockpile at the foot of the slope. The stockpile would be cleared the next morning as discussed below.

(e) Replacing noisy methods by quiet methods

Quiet techniques are available for some construction operations. For example, conventional concrete breaking and rock drilling could be replaced by quiet techniques such as the ones described in "A Practical Guide for the Reduction of Noise from Construction Works", published by the Environmental Protection Department. The construction contract will specify that appropriate quiet methods shall be used where practicable.

(f) Avoiding certain activities in restricted hours

Surface activities could be minimized during restricted hours. Overnight work could be limited to essential activities only and non-essential work could stop at 11 p.m. It has been assumed that spoil mucked out from tunnelling on Tsing Yi at night would be stockpiled for transportation in the next working day. The stockpiles would be at the barge loading site as it would be impractical to construct stockpiles close to the tunnel entrance. In this case conveyors or chutes leading to the stockpile would need to be screened.

The assessment of construction noise has assumed that appropriate mitigation will be applied at source wherever practical. Table 4.1 shows the sound power levels that have been used with and without mitigation at source. Three methods of mitigation at source have been assumed in this stage of the assessment:-

- (a) Method A - fit exhaust mufflers and an acoustic lining to the engine compartments of mobile plant;
- (b) Method B - construct an acoustic enclosure around stationary plant. It has been assumed that an acoustic enclosure would be constructed around the entrance of the tunnel for the Tsing Yi anchorage; and
- (c) Method C - construct an acoustic enclosure around the diesel engines of stationary plant.

In addition it has been assumed that an acoustic enclosure will be constructed around the Tsing Yi anchor tunnel, spoil chutes and stockpile.

Table 4.1 Noise Mitigation

Ref.* No.	Equipment Item	SPL without mitigation dB(A)	Proposed mitigation dB(A)	SPL with mitigation dB(A)
CNP002	Compressor	100	-	100
CNP022	Batch plant	108	C	101
CNP022	Batch plant (barge)	108	C	101
CNP030	Bulldozer	115	A	110
CNP044	Truck mixer	109	-	109
CNP044	Concrete truck	109	-	109
CNP047	Concrete pump	109	B	94
CNP048	Mobile crane	112	A	107
CNP048	Crawler crane	112	A	107
CNP048	Diesel crane	112	A	107
CNP049	Tower crane	95	-	95
CNP061	Derrick barge	104	-	104
CNP063	Dredger (grab)	112	A	107
CNP064	Drill platform	103	-	103
CNP065	Air tools	98	-	98
CNP065	Air wrench	98	-	98
CNP067	Truck	117	A	117
CNP081	Excavator	112	A	107
CNP081	Small excavator	112	A	107
CNP102	Generator	100	-	100
CNP121	Lifting gear	108	-	108
CNP122	Personnel lift	95	-	95
CNP122	Inclined escalator	95	-	95
CNP170	Hand held vibratory poker	113	-	113
CNP181	Drill	128	A	123
CNP221	Tug boat	110	A	105
CNP221	Safety boat	110	A	105
CNP241	Ventilator	108	-	108
CNP262	Electric winch	95	-	95
CNP262	Unreeler	95	-	95
CNP262	Pulling winch	95	-	95
CNP262	Travelling winch	95	-	95
CNP262	Lifting winch	95	-	95

Notes: (a)* Same as Identification code in the TM

(b) Methods of Mitigation are:-

- A - Fit exhaust mufflers and an acoustic lining to the engine compartments of mobile plant
- B - Construct an acoustic enclosure around stationary plant
- C - Construct an acoustic enclosure around the diesel engines of stationary plant

The last stage in the assessment has been to consider other methods of mitigation including mitigation at receivers where noise levels are predicted to exceed those defined as acceptable in the TM. These could be noise barriers near the source or near the receivers or noise insulation of the receivers. Noise barriers near receivers may pose land acquisition or maintenance problems and will be visually intrusive but nevertheless may be an acceptable solution.

4.4 Construction Activities

Figures 4.1, 4.2 and 4.3 show an outline of the design for the Tsing Ma Bridge. An assessment of the method of construction of the bridge, focusing on those activities which will produce the greatest noise impact, is included in Appendix H. The construction plant assumed for each of these activities is listed in Appendix I. It has been assumed that the construction of the bridge will start in April 1992 with completion in March 1997 and Figure 4.4 shows the assumed construction programme.

The Kap Shui Mun Bridge has been assumed to be of similar form to the Tsing Ma Bridge and a similar construction method to that described in Annex A has been assumed. The assumed programme for the Kap Shui Mun Bridge is shown on Figure 4.5 and the construction activities are shown in Appendix I.

The Ma Wan Viaduct has been assumed to be a continuous concrete structure constructed in-situ. Precast construction would also be feasible but the insitu construction would probably be noisier. The activities have been taken as being concentrated at each of the piers. The construction activities for the Ma Wan Viaduct are shown in Appendix I and the assumed programme is shown on Figure 4.6.

4.5 Sensitive Receivers

The sensitive receivers which are likely to be affected by the construction of Tsing Ma Bridge and the Kap Shui Mun Bridge/Ma Wan Viaducts are listed in Table 4.2 together with the associated land use. The locations of these receivers are given in Figure 4.7.

Table 4.2 Sensitive Receivers

NSR	I.D.	Location	Land Use
San Po Tsui	L2	North Lantau	Residential
Tai Chuen	L3	North Lantau	Residential
Yi Chuen	L4	North Lantau	Residential
Tso Wan	L5	North Lantau	Residential
Fa Peng	L6	North Lantau	Residential
Ma Wan Town	M1	Ma Wan	Community Centre
Ma Wan Town	M2	Ma Wan	Residential
Tin Liu	M3	Ma Wan	Residential
Tin Liu	M4	Ma Wan	Residential
Lau Fa Tsuen	M5	Ma Wan	Residential
Tai Lung	M6	Ma Wan	Residential
Temple	M7	Ma Wan	Place of Worship (day) Dormitory (evening and night)
Ma Wan Town	M8	Ma Wan	Residential
Ma Wan Town	M9	Ma Wan	Residential
Ma Wan Town	M10	Ma Wan	Residential
Tin Liu	M11	Ma Wan	Residential
Lau Fa Tsuen	M12	Ma Wan	Residential
Ngau Kok Wan	T1	Tsing Yi	Residential
Yau Kom Tau	T2	Tsing Yi	Residential
Proposed District Hospital and Cheung Hang Estate	T3	Tsing Yi	Residential
Ching Wah Court	T11	Tsing Yi	Residential
Tsing Lung Tau	C1	Castle Peak	Residential
Sham Tseng	C2	Castle Peak	Residential
Ting Kau	C3	Castle Peak	Residential
Ting Kau	C4	Castle Peak	Residential
Ting Kau	C5	Castle Peak	Residential
Ting Kau	C6	Castle Peak	Residential
Ting Kau	C7	Castle Peak	Residential

4.6 Acceptable Noise Levels

The method of calculating Acceptable Noise Levels (ANLs) is defined in the TM. Area Sensitivity Ratings (ASRs) are firstly assessed in accordance with Table 4.3 which is extracted from the TM. The Basic Noise Level (BNL) is then calculated in accordance with Table 4.4, again extracted from the TM, and the ANL is calculated by adjusting the BNL to allow for the duration of the activity and for multiple site situations.

Table 4.3 Area Sensitivity Ratings (ASRs)

Type of Area Containing NSR	Degree to which NSR is affected by IF		
	Not Affected	Indirectly Affected	Directly Affected
i) Rural area, including country parks or village type developments	A	B	B
ii) Low density residential area consisting of low-rise or isolated high-rise developments	A	B	C
iii) Urban Area	B	C	C
iv) Area other than those above	B	B	C

Table 4.4 Basic Noise Levels (BNLs)

Time Period	ASR		
	A	B	C
All days during the evening (1900 to 2300 hours), and general holidays (including Sundays) during the day-time and evening (0700 to 2300 hours)	60	65	70
All days during the night-time (2300 to 0700 hours)	45	50	55

✓ Sensitive receivers on Lantau and Ma Wan would fall into Area Type (i) or possibly (ii) in Table 4.3. Sensitive receivers in Castle Peak would probably fall into Area Type (ii) while those on Tsing Yi would fall into Area Type (ii) or possible (iii). ASR A would therefore apply to the area likely to be affected by construction noise with ANLs of 60 dB(A) and 45 d(A).

4.7 Noise from Construction of the Tsing Ma Bridge

4.7.1 General

The sound power levels at source for each activity with and without mitigation are listed in Tables 4.5 to 4.9. Mitigation at this stage refers to methods A, B and C discussed above. Tables 4.10, 4.11 and 4.12 list the noise at each receiver and highlight the exceedance of the ANL criteria.

The assessment of the noise has focused on the figures in Tables 4.11 and 4.12 since it has been assumed that mitigation at source (methods A, B and C as discussed above) will be applied.

Table 4.5 Sound Power Levels from Tsing Ma Bridge/Ma Wan Substructure

Activity	Sound power level		Method of mitigation
	Without mitigation dB(A)	With mitigation dB(A)	
A. MA WAN SUBSTRUCTURE			
A.1 Excavation for anchor	138	133	A
A.2 Sha Lau Tung Wan	121	118	A
A.3 Concrete for anchor	122	122	B,C
A.4 Ship impact protection	123	122	A
A.5 Concrete for piers M1 and M2	124	123	A,B,C

Table 4.6 Sound Power Levels for Tsing Ma Bridge/Tower Construction

Activity	Sound power level		Method of mitigation
	Without mitigation dB(A)	With mitigation dB(A)	
B. TOWER CONSTRUCTION			
B.1 Excavate for Tsing Yi tower	137	133	A
B.2 Concrete for Tsing Yi tower	126	126	A,B,C
B.3 Excavate for Ma Wan tower	116	113	A
B.4 Concrete for Ma Wan tower	123	122	A,B,C
B.5 Ma Wan tower leg construction	121	121	-
B.6 Tsing Yi tower leg construction	122	122	-

Table 4.7 Sound Power Levels from Tsing Ma Bridge/Tsing Yi Substructure

Activity	Sound power level		Method of mitigation
	Without mitigation dB(A)	With mitigation dB(A)	
C. TSING YI SUBSTRUCTURE			
C.1 Excavate for anchor	138	133	A
C.2 Tunnel for anchor	136	131	A
C.3 Concrete for anchor	122	121	B,C
C.4 Concrete for abutment	121	120	A,B,C
C.5 Excavate for piers T2, T3	131	127	A
C.6 Concrete for piers T2, T3	121	120	A,B,C
C.7 Excavate for pier T1	131	127	A
C.8 Concrete for pier T1	121	120	A,B,C

Table 4.8 Sound Power Levels from Tsing Ma Bridge/Suspension Cables

Activity	Sound power level		Method of mitigation
	Without mitigation dB(A)	With mitigation dB(A)	
D. SUSPENSION CABLES			
D.1 Cat walk construction	105	105	-
D.2 Main Cable Construction	106	106	-

Table 4.9 Sound Power Levels from Tsing Ma Bridge/Deck Superstructure

Activity	Sound power level		Method of mitigation
	Without mitigation dB(A)	With mitigation dB(A)	
E. DECK SUPERSTRUCTURE			
E.1 Ma Wan approach span assembly	116	113	A
E.2 Tsing Yi approach span assembly	116	113	A
E.3 Deck Raising	121	118	A

4.7.2 Impacts during Period 1

There will be exceedance of the ANL at receivers M6, M7, C2, C3 and C4 during construction of the Ma Wan substructure, Tsing Yi tower and Tsing Yi substructure. The ANLs will be exceeded at receiver M7 during nearly all the construction activities on Ma Wan.

The exceedance will be mainly due to the use of rock drills and during concreting. The following options for reducing the noise to acceptable levels could be considered:-

- (a) by using quieter rock drills. The sound power level assumed for the drills is 128 dB(A) in accordance with the TM. However similar equipment is available with a sound power level of as little as 110 dB(A);
- (b) if the contractor wished to maintain the number of powered mechanical equipment he could erect noise screens close to the source. These screens would have to be mobile and may have to be moved several times each week.

The contractor could choose to use a combination of these methods if this is more appropriate to his method of working.

The biggest exceedance will be at receiver M7 during excavation for the Ma Wan anchorage, piers and tower foundations. Noise levels from the pier and tower foundations could be reduced to acceptable levels by using quieter plant. Screens could be used as an alternative or in addition. However the noise from the anchorage excavation could not be reduced to acceptable levels without effectively prohibiting the activity.

4.7.3 Impacts during Period 2

The proposed ANLs will be exceeded during Period 2 at all receivers on Ma Wan, most receivers at Castle Peak and one receiver on Tsing Yi during excavation for the Ma Wan anchorage and piers. There will also be widespread exceedance at Castle Peak during construction of the Tsing Yi and Ma Wan towers and substructure. The largest exceedance of the proposed ANL's will be at receivers M6 and M7 on Ma Wan.

The exceedance at most receivers may be minimised using a similar approach to that for Period 1, namely using quieter plant, or by installing noise screens or enclosures. However the noise levels at many receivers cannot be reduced to acceptable levels without effectively prohibiting the excavation and concreting activities.

4.7.4 Noise Mitigation at Receivers

It has been concluded that noise at receivers cannot be reduced to acceptable levels during excavation and concreting of the bridge anchorages, pier and tower foundations and M7 in particular will be affected by nearly all construction activities on Ma Wan. It is recommended that mitigation at the receivers be considered for these receivers. This would require funding for installation and operation of air conditioners or for installation of screens close to the receivers.

Table 4.10 Tsing Ma Bridge Construction Noise - Without Mitigation

NSR/ ACT	Noise levels in dB(A)																							
	A.1	A.2	A.3	A.4	A.5	B.1	B.2	B.3	B.4	B.5	B.6	C.1	C.2	C.3	C.4	C.5	C.6	C.7	C.8	D.1	D.2	E.1	E.2	E.3
L2	56	38	40	40	41	47	36	31	39	41	52	52	48	34	34	41	34	42	33	21	23	43	30	38
L3	57	59	41	41	43	51	40	32	39	47	53	62	54	40	40	44	40	48	39	22	24	43	36	38
L4	58	39	41	41	51	52	41	33	40	47	53	62	55	41	46	45	41	49	40	22	28	49	41	44
L5	56	37	38	39	54	54	43	32	40	46	51	62	60	46	45	48	45	50	44	21	27	46	41	48
L6	53	34	36	36	47	61	50	31	38	45	49	61	59	45	44	55	45	55	44	26	28	44	40	47
M1	59	41	44	44	44	49	38	34	41	35	50	48	46	32	31	42	32	42	31	24	24	41	27	36
M2	62	44	47	46	46	49	38	35	43	34	41	49	47	33	32	43	33	42	32	27	27	39	28	36
M3	62	44	47	46	47	50	39	36	43	34	44	49	47	33	32	43	33	43	32	27	27	39	28	37
M4	63	45	48	47	48	50	39	37	44	34	43	49	47	34	33	44	33	43	33	28	28	40	28	37
M5	64	45	49	48	48	50	39	36	44	34	42	49	47	33	32	43	33	43	32	29	29	40	28	37
M6	69	48	54	50	60	65	55	53	61	50	59	65	63	49	48	59	49	58	48	34	36	58	44	53
M7	89	67	73	69	70	66	55	55	63	50	61	65	63	49	49	60	49	59	49	53	53	62	44	54
T1	49	33	34	35	35	57	46	29	36	41	35	60	58	44	43	52	42	53	43	25	25	28	37	36
T2	48	31	32	33	34	54	43	27	35	38	33	57	56	42	41	49	39	51	40	22	23	26	34	34
T3	47	31	32	33	34	54	43	27	34	38	33	57	55	42	41	49	39	51	40	22	22	26	34	34
T11	62	45	46	47	48	57	47	41	49	51	47	63	55	41	42	49	46	49	41	27	29	40	41	47
C1	50	33	35	35	44	61	50	37	44	45	48	61	58	45	44	54	44	54	44	25	27	43	39	46
C2	67	50	51	52	53	64	53	45	52	48	51	64	62	48	47	58	47	57	47	33	34	45	43	49
C3	68	51	52	53	54	67	56	47	54	51	53	67	65	51	50	61	50	60	50	34	36	46	46	52
C4	67	51	52	53	53	68	57	47	54	52	53	68	66	52	51	62	52	61	51	35	36	46	47	52
C5	65	48	49	50	51	66	55	44	51	50	50	58	49	39	40	60	49	45	43	29	31	43	45	49
C6	63	46	47	49	49	52	41	42	50	52	48	62	52	38	39	47	37	47	37	28	30	41	33	48
C7	62	46	46	48	48	51	41	41	49	51	47	53	51	38	37	46	45	47	36	27	29	40	46	42

- 4.12 -

Table 4.11 Exceedance of ANL for Period 1 - With Mitigation Methods A, B and C

NSR/ ACT	Noise levels in dB(A)																							
	A.1	A.2	A.3	A.4	A.5	B.1	B.2	B.3	B.4	B.5	B.6	C.1	C.2	C.3	C.4	C.5	C.6	C.7	C.8	D.1	D.2	E.1	E.2	E.3
L2	51	35	40	39	40	43	36	28	38	41	52	48	43	33	33	36	33	38	32	21	23	40	27	38
L3	52	36	41	39	42	46	39	28	38	47	53	57	49	39	39	40	40	44	38	22	24	40	33	37
L4	53	36	41	39	51	47	40	29	39	47	53	57	50	41	44	41	40	45	39	22	28	46	38	44
L5	51	33	38	37	53	49	42	29	39	46	51	57	55	45	44	43	45	46	43	21	27	43	37	45
L6	48	31	35	35	46	57	50	28	37	45	49	57	54	45	43	50	44	50	43	26	28	41	37	44
M1	55	38	43	42	43	44	37	30	40	35	50	44	41	32	30	38	31	37	31	24	24	37	24	34
M2	58	41	46	44	46	45	38	32	42	34	41	44	42	32	31	38	32	38	31	27	27	36	24	34
M3	57	41	46	44	46	45	38	33	42	34	44	45	42	33	31	39	32	38	32	27	27	36	25	34
M4	58	42	47	46	47	46	39	33	43	34	43	45	42	33	32	39	32	39	32	28	28	37	25	35
M5	60	42	48	46	47	45	38	33	43	34	42	45	42	33	31	39	32	38	32	29	29	37	25	34
M6	64	45	53	49	59	61	54	50	60	50	59	60	58	48	47	54	48	54	47	34	36	55	40	50
M7	64	64	73	68	68	62	55	52	62	50	61	61	58	49	47	55	48	55	48	53	53	59	41	52
T1	44	30	33	33	34	52	45	25	35	41	35	55	53	44	42	47	41	49	42	25	25	24	33	33
T2	43	28	32	32	35	50	43	24	34	38	33	52	51	41	40	44	38	46	39	22	23	23	31	31
T3	43	28	31	31	33	49	43	24	33	38	33	52	51	41	40	44	38	46	39	22	22	23	31	31
T11	57	42	46	46	47	53	46	38	48	51	47	58	50	40	41	44	45	45	40	27	29	37	38	45
C1	46	30	34	34	43	56	49	33	43	45	48	56	54	44	43	50	43	50	43	25	27	40	36	43
C2	62	47	51	51	52	59	53	42	51	48	51	59	57	47	46	53	46	53	46	33	34	42	39	46
C3	63	48	52	52	53	62	56	43	53	51	53	62	60	50	49	56	50	56	49	34	36	43	42	49
C4	63	48	51	51	53	63	57	43	53	52	53	63	61	51	50	57	51	57	50	35	36	43	43	49
C5	60	45	49	49	50	61	54	41	50	50	50	53	44	36	36	55	49	40	42	29	31	40	41	46
C6	58	43	47	47	48	48	41	39	49	52	48	57	47	37	38	42	36	43	36	28	30	38	30	46
C7	57	42	46	46	47	47	40	38	48	51	47	49	46	37	36	41	44	42	35	27	29	37	43	42

Note : Shaded figures are exceedance of 60 dB(A)

Table 4.12 Exceedance of ANL for Period 2 - With Mitigation Methods A, B and C

NSR/ ACT	Noise levels in dB(A)																							
	A.1	A.2	A.3	A.4	A.5	B.1	B.2	B.3	B.4	B.5	B.6	C.1	C.2	C.3	C.4	C.5	C.6	C.7	C.8	D.1	D.2	E.1	E.2	E.3
L2	51	35	40	39	40	43	36	28	38	41	52	48	43	33	33	36	33	38	32	21	23	40	27	38
L3	52	36	41	39	42	46	39	28	38	47	53	57	49	39	39	40	40	44	38	22	24	40	33	37
L4	53	36	41	39	51	47	40	29	39	47	53	57	50	41	44	41	40	45	39	22	28	46	38	44
L5	51	33	38	37	53	49	42	29	39	46	51	57	55	45	44	43	45	46	43	21	27	43	37	45
L6	48	31	35	35	46	57	50	28	37	45	49	57	54	45	43	50	44	50	43	26	28	41	37	44
M1	55	38	43	42	43	44	37	30	40	35	50	44	41	32	30	38	31	37	31	24	24	37	24	34
M2	58	41	46	44	46	45	38	32	42	34	41	44	42	32	31	38	32	38	31	27	27	36	24	34
M3	57	41	46	44	46	45	38	33	42	34	44	45	42	33	31	39	32	38	32	27	27	36	25	34
M4	58	42	47	46	47	46	39	33	43	34	43	45	42	33	32	39	32	39	32	28	28	37	25	35
M5	60	42	48	46	47	45	38	33	43	34	42	45	42	33	31	39	32	38	32	29	29	37	25	34
M6	64	45	53	49	59	61	54	50	60	50	59	60	58	48	47	54	48	54	47	34	36	56	40	50
M7	64	64	73	68	69	62	55	52	62	50	61	61	56	49	47	55	48	55	48	53	53	59	41	52
T1	44	30	33	33	34	52	45	25	35	41	35	55	53	44	42	47	41	49	42	25	25	24	33	33
T2	43	28	32	32	35	50	43	24	34	38	33	52	51	41	40	44	38	46	39	22	23	23	31	31
T3	43	28	31	31	33	49	43	24	33	38	33	52	51	41	40	44	38	46	39	22	22	23	31	31
T11	57	42	46	46	47	53	46	38	48	51	47	58	50	40	41	44	45	45	40	27	29	37	38	45
C1	46	30	34	34	43	56	49	33	43	45	48	56	54	44	43	50	43	50	43	25	27	40	36	43
C2	62	47	51	51	52	59	53	42	51	48	51	59	57	47	46	53	46	53	46	33	34	42	39	46
C3	63	48	52	52	53	62	56	43	53	51	59	62	60	50	49	56	50	56	49	34	36	43	42	49
C4	63	48	51	51	53	63	57	43	53	52	53	63	61	51	50	57	51	57	50	35	36	43	43	49
C5	60	45	49	49	50	61	54	41	50	50	50	53	44	36	36	55	49	40	42	29	31	40	41	46
C6	58	43	47	47	48	48	41	39	49	52	48	57	47	37	38	42	36	43	36	28	30	38	30	46
C7	57	42	46	46	47	47	40	38	48	51	47	49	46	37	36	41	44	42	35	27	29	37	43	42

Note: Shaded figures are exceedance of 45 dB(A)

4.7.5 Conclusions and Recommendations

It will not be possible to carry out 24 hour working for the construction of the Tsing Ma Bridge without exceeding the proposed ANLs. It is recommended that sound insulation be considered for all receivers likely to be affected by excessive noise.

It has agreed that an exemption to the NCO should be applied for on the basis that contractors will take all practicable steps to minimise noise and that noise insulation, comprising installation of air conditioners and window insulation, should be applied to all properties on Ma Wan and North Lantau that would be affected by excessive noise. The noise levels included in the exemption are shown in Table 4.13.

Table 4.13 Maximum Noise Levels for the Tsing Ma Bridge Contract

Time Period	Ma Wan and North Lantau dB(A)	Ting Kau Sham Tseng and Tsing Lung Tan dB(A)
Period 1	75	60
Period 2	70	55

4.8 Noise from the Construction of the Kap Shui Mun Bridge/Ma Wan Viaducts

4.8.1 General

The sound power levels from each activity with and without mitigation are listed in Tables 4.14 to 4.22 for the Kap Shui Mun Bridge and Tables 4.23 to 4.24 for the Ma Wan Viaducts. The mitigation methods refer to those listed in Section 4.3 above.

Table 4.25 shows the noise at each of the receivers from the construction of the Kap Shui Mun Bridge and Tables 4.26 and 4.27 show the predicted exceedance of the ANLs during time periods 1 and 2. Tables 4.28 to 4.30 show similar information for the construction of the Ma Wan Viaducts.

Table 4.14 Sound Power Levels from Kap Shui Mun Bridge/Lantau Works Site

Activity	Sound power level		Method of mitigation
	Without mitigation dB(A)	With mitigation dB(A)	
A. Lantau Works Site (Tai Chuen)			
A.1 Dredging	116	113	A
A.2 Place Seawalls (concrete block)	112	109	A
A.3 Reclamation	122	121	A

Table 4.15 Sound Power Levels from Kap Shui Mun Bridge/Ma Wan Works Site

Activity	Sound power level		Method of mitigation
	Without mitigation dB(A)	With mitigation dB(A)	
B. Ma Wan Works Site			
B.1 Dredging	116	113	A
B.2 Place Seawalls (concrete block)	112	109	A
B.3 Reclamation	122	121	A

Table 4.16 Sound Power Levels from Kap Shui Mun Bridge/Lantau Anchorage

Activity	Sound power level		Method of mitigation
	Without mitigation dB(A)	With mitigation dB(A)	
C. Lantau Anchorage			
C.1 Excavation	134	129	A
C.2 Concreting	120	119	B,C

Table 4.17 Sound Power Levels from Kap Shui Mun Bridge/Ma Wan Anchorage

Activity	Sound power level		Method of mitigation
	Without mitigation dB(A)	With mitigation dB(A)	
D. Ma Wan Anchorage			
D.1 Excavation	134	129	A
D.2 Concreting	120	119	B,C

Table 4.18 Sound Power Levels from Kap Shui Mun Bridge/Lantau Tower

Activity	Sound power level		Method of mitigation
	Without mitigation dB(A)	With mitigation dB(A)	
E. Lantau Tower			
E.1 Excavation for foundations	134	130	A
E.2 Concrete for foundations	121	120	A,B,C
E.3 Legs construction	120	119	B,C
E.4 Concrete for cross beams			

Table 4.19 Sound Power Levels from Kap Shui Mun Bridge/Ma Wan Tower

Activity	Sound power level		Method of mitigation
	Without mitigation dB(A)	With mitigation dB(A)	
F. Ma Wan Tower			
F.1 Excavation for foundations	134	130	A
F.2 Concrete for foundations	121	120	A,B,C
F.3 Legs construction	120	119	B,C

Table 4.20 Sound Power Levels from Kap Shui Mun Bridge/Lantau Pier

Activity	Sound power level		Method of mitigation
	Without mitigation dB(A)	With mitigation dB(A)	
G. Lantau Pier			
G.1 Excavation	128	123	A
G.2 Concrete	119	118	A,B,C

Table 4.21 Sound Power Levels from Kap Shui Mun Bridge/Ma Wan Pier

Activity	Sound power level		Method of mitigation
	Without mitigation dB(A)	With mitigation dB(A)	
H. Ma Wan Pier			
H.1 Excavation	128	123	A
H.2 Concrete	119	118	A,B,C

Table 4.22 Sound Power Levels from Kap Shui Mun Bridge/Deck Superstructure

Activity	Sound power level		Method of mitigation
	Without mitigation dB(A)	With mitigation dB(A)	
I. Deck Superstructure			
I.1 Cat walk	105	105	-
I.2 Cable spinning	106	106	-
I.3 Deck Raising	121	117	A

Table 4.23 Sound Power Levels from Ma Wan Viaducts/Piers A to H

Activity	Sound power level		Method of mitigation
	Without mitigation dB(A)	With mitigation dB(A)	
Piers A to H			
A.1 to H.1 Excavation	131	126	A
A.2 to H.2 Concrete for footing	120	120	
A.3a to H.3a Concrete for pier	121	120	A,B
A.3b to H.3b Concrete for pier	121	120	A,B
A.4 to H.4 Concrete for deck	121	120	A,B

Note: Sound power levels from each pier will be the same

Table 4.24 Sound Power Levels from Ma Wan Viaducts/Works Area and Haul Road

Activity	Sound power level		Method of mitigation
	Without mitigation dB(A)	With mitigation dB(A)	
I. Works Area			
I.1 Batch Plant	108	101	C
J. Haul Road			
J.1 Concrete trucks	118	118	-

4.8.2 Impacts during Period 1

Kap Shui Mun Bridge

Noise levels will exceed the ANL at nearly all the receivers during excavation and concreting activities (Table 4.26). The only receivers on Ma Wan which will not be affected by high noise levels from the Kap Shui Mun Bridge will be part of Tin Liu (M4). The only receiver on Lantau which will not be adversely affected will be Tso Wan (L5).

Most of the exceedance on Ma Wan is due to the excavation for the Ma Wan anchorage and tower foundations of the bridge. The excavation will be within a fairly small area and it would be possible to erect noise screens close to the noise source to protect the receivers such that work on the Kap Shui Mun bridge could proceed during Period 1 without exceeding the ANLs on Ma Wan.

The exceedance on Lantau is much higher, particularly at Tai Chuen (L3), and it is unlikely that noise screens would be sufficient to reduce the noise to acceptable levels.

Ma Wan Viaducts

There is some exceedance of the ANLs in Ma Wan Town (M1 and M2) due to activities at the Ma Wan works site and the Lantau works site and anchorage (Table 4.28). The exceedance is less than 10 dB(A) and could probably be reduced by the use of noise screens. There is, however, a much larger exceedance at Lau Fa, Tai Lung, the temple and at Lau Fa Tsuen (M5, M6, M7 and M12). The exceedance is generally 15 to 20 dB(A) but reaches nearly 25 dB(A) for some activities. It is unlikely that mitigation at source could be applied to reduce the noise to acceptable levels.

There is no exceedance of ANLs on Lantau from the construction of the Ma Wan Viaducts.

Table 4.25 Kap Shui Mun Bridge Construction Noise - Without Mitigation

NSR/ ACT	Noise levels in dB(A)																								
	A.1	A.2	A.3	B.1	B.2	B.3	C.1	C.2	D.1	D.2	E.1	E.2	E.3a	E.3b	F.1	F.2	F.3a	F.3b	G.1	G.2	H.1	H.2	I.1	I.2	I.3
L2	67	64	74	56	52	63	79	65	67	53	80	67	65	65	74	61	60	60	73	65	67	58	50	53	67
L3	67	63	74	58	54	65	87	72	69	54	100	87	85	75	76	63	62	62	88	79	69	60	58	60	71
L4	48	44	55	57	53	64	70	56	68	53	81	68	67	67	75	62	61	61	75	66	68	59	43	51	68
L5	42	38	49	40	36	47	62	48	57	43	62	48	47	47	59	45	44	44	56	47	52	43	34	37	50
M1	55	51	61	57	54	64	72	57	76	62	73	60	59	59	77	64	62	62	66	57	70	62	49	51	65
M2	44	40	51	51	48	58	61	47	83	69	63	50	49	49	72	58	57	66	56	48	71	63	54	55	56
M3	41	37	48	45	41	52	59	44	75	61	60	47	46	55	64	51	50	60	53	44	58	50	46	47	51
M4	40	36	47	44	40	51	63	48	64	50	59	46	45	55	63	50	49	59	57	49	57	49	38	39	51
M5	43	39	50	51	47	58	61	46	87	72	63	50	48	48	71	58	57	66	56	47	72	64	58	59	55
M6	41	37	48	47	43	54	59	44	79	64	61	47	46	56	66	53	52	62	54	45	66	58	50	51	52
M7	39	36	46	45	41	52	58	43	66	51	59	46	45	55	64	51	50	60	52	44	59	50	37	39	51
M8	53	49	60	56	52	63	70	56	75	61	72	58	57	57	75	62	61	61	65	56	69	60	47	50	63
M9	53	49	60	49	45	56	71	56	80	65	72	59	58	58	69	55	54	64	65	57	68	59	52	53	60
M10	42	39	49	47	44	54	60	45	78	64	62	48	47	52	67	54	53	63	55	46	72	63	50	49	57
M11	41	37	48	45	42	52	59	44	76	62	60	47	46	56	65	52	51	60	53	45	69	61	47	49	59
M12	42	38	49	49	45	56	60	45	82	67	62	48	47	52	69	56	54	64	55	46	74	65	53	48	54

Table 4.26 Exceedance of ANL for Period 1 for the Kap Shui Mun Bridge - With Mitigation Methods A, B and C

NSR/ ACT	Noise levels in dB(A)																								
	A.1	A.2	A.3	B.1	B.2	B.3	C.1	C.2	D.1	D.2	E.1	E.2	E.3a	E.3b	F.1	F.2	F.3a	F.3b	G.1	G.2	H.1	H.2	I.1	I.2	I.3
L2	65	61	73	54	49	61	74	64	62	52	75	65	65	64	70	59	59	59	68	63	62	57	50	53	63
L3	65	60	72	56	52	64	82	72	64	54	96	85	85	75	72	62	61	61	83	78	64	59	58	60	67
L4	46	42	54	55	51	62	65	55	63	53	77	67	66	66	71	60	60	60	70	65	63	58	43	51	64
L5	40	35	47	38	34	46	57	47	52	42	57	47	47	46	54	44	44	44	51	46	47	42	34	37	45
M1	52	48	60	55	51	63	57	56	71	61	59	58	58	58	72	62	62	61	61	56	65	60	49	51	61
M2	42	37	49	49	45	57	56	46	78	88	59	49	48	48	67	57	56	66	51	46	56	61	54	55	52
M3	39	34	46	43	38	50	54	43	70	60	56	45	45	55	60	49	49	59	48	43	53	48	46	47	47
M4	38	34	46	42	37	49	58	48	59	49	55	44	44	54	59	48	48	58	52	47	52	47	38	39	46
M5	41	36	48	49	45	57	56	46	62	72	58	48	48	48	67	57	56	66	51	45	67	62	58	59	51
M6	39	34	46	45	40	52	54	44	74	64	56	46	45	55	62	52	51	61	49	43	61	56	50	51	48
M7	37	33	45	43	38	50	53	43	61	50	55	45	44	54	60	49	49	59	47	42	54	48	37	39	47
M8	51	46	58	54	49	61	65	55	70	60	67	57	57	56	71	60	60	60	60	55	64	59	47	50	59
M9	51	47	58	47	42	54	66	55	76	65	66	58	57	57	64	54	54	63	60	55	63	58	52	53	55
M10	40	36	48	45	41	53	55	45	74	63	57	47	47	51	63	52	52	62	50	44	67	61	50	49	53
M11	39	35	47	43	39	51	54	44	71	61	56	46	45	55	61	50	50	60	49	43	64	59	47	49	55
M12	40	35	47	47	42	54	55	45	77	67	57	47	47	51	64	54	54	63	50	44	69	64	53	48	50

Note : Shaded figures are exceedance of 60 dB(A)

Table 4.27 Exceedance of ANL for Period 2 for the Kap Shui Mun Bridge - With Mitigation Methods A, B and C

NSR/ ACT	Noise levels in dB(A)																								
	A.1	A.2	A.3	B.1	B.2	B.3	C.1	C.2	D.1	D.2	E.1	E.2	E.3a	E.3b	F.1	F.2	F.3a	F.3b	G.1	G.2	H.1	H.2	I.1	I.2	I.3
L2	65	61	73	54	49	61	74	64	62	52	75	65	65	64	70	59	59	59	68	63	62	57	50	53	63
L3	65	60	72	56	52	64	82	72	64	54	96	85	85	75	72	62	61	61	83	78	64	59	58	60	67
L4	46	42	54	55	51	62	65	55	63	53	77	67	66	66	71	60	60	60	70	65	63	58	43	51	64
L5	40	35	47	38	34	46	57	47	52	42	57	47	47	46	54	44	44	44	51	46	47	42	34	37	45
M1	52	48	60	55	51	63	57	56	71	61	59	58	58	58	72	62	62	61	61	56	65	60	49	51	61
M2	42	37	49	49	45	57	56	46	78	68	59	49	48	48	67	57	56	66	51	46	66	61	54	55	52
M3	39	34	46	43	38	50	54	43	70	60	56	45	45	55	60	49	49	59	48	43	53	48	46	47	47
M4	38	34	46	42	37	49	58	48	59	49	55	44	44	54	59	48	48	58	52	47	52	47	38	39	46
M5	41	36	48	49	45	57	56	46	62	72	58	48	48	48	67	57	56	66	51	45	67	62	58	59	51
M6	39	34	46	45	40	52	54	44	74	64	56	46	45	55	62	52	51	61	49	43	61	56	50	51	48
M7	37	33	45	43	38	50	53	43	51	50	55	45	44	54	60	49	49	59	47	42	54	48	37	39	47
M8	51	46	58	54	49	61	65	55	70	60	67	57	57	56	71	60	60	60	60	55	64	59	47	50	59
M9	51	47	58	47	42	54	66	55	75	65	68	58	57	57	64	54	54	63	60	55	63	58	52	53	55
M10	40	36	48	45	41	53	55	45	74	63	57	47	47	51	63	52	52	62	50	44	67	61	50	49	53
M11	39	35	47	43	39	51	54	44	71	61	56	46	45	55	61	50	50	60	49	43	64	59	47	49	55
M12	40	35	47	47	42	54	55	45	77	67	57	47	47	51	64	54	54	63	50	44	69	64	53	48	50

Note : Shaded figures are exceedance of 45 dB(A)

Table 4.28 Ma Wan Viaducts Construction Noise - Without Mitigation

NSR/ ACT	Noise levels in dB(A)																			
	A.1	A.2	A.3a	A.3b	A.4	B.1	B.2	B.3a	B.3b	B.4	C.1	C.2	C.3a	C.3b	C.4	D.1	D.2	D.3a	D.3b	D.4
L2	59	47	48	58	58	58	47	48	58	58	57	46	47	57	57	57	46	47	57	57
L3	60	49	50	60	60	59	48	49	59	59	58	47	48	48	48	58	46	47	47	47
L4	59	46	49	59	59	59	47	48	58	58	58	47	48	58	58	57	46	47	57	57
L5	54	43	44	44	44	54	43	43	43	43	53	42	43	43	43	53	42	43	43	43
M1	63	52	53	63	63	63	51	52	62	62	62	51	52	62	62	66	55	56	61	61
M2	70	59	60	70	70	70	58	59	69	69	68	57	58	68	68	67	56	56	66	66
M3	63	51	52	62	62	63	52	53	63	63	63	52	53	63	63	63	52	53	53	53
M4	62	50	51	51	51	62	51	52	52	52	63	52	53	52	52	63	52	53	53	53
M5	88	77	78	76	76	92	81	82	79	79	88	76	77	76	76	83	72	73	72	72
M6	78	66	67	67	67	80	69	70	69	69	83	72	73	72	72	87	76	77	76	76
M7	64	52	53	58	58	65	54	55	60	60	67	55	56	66	66	68	57	58	68	68
M8	62	51	52	62	62	62	51	52	62	62	62	51	51	61	61	61	50	51	61	61
M9	72	61	62	67	67	73	61	62	67	67	72	61	62	67	67	71	60	61	66	66
M10	66	55	56	66	66	66	55	56	66	66	66	55	56	66	66	66	54	55	65	65
M11	64	52	53	63	63	64	53	54	59	59	65	53	54	59	59	65	53	54	59	59
M12	81	70	71	71	71	84	73	74	73	73	86	75	76	75	75	85	74	75	74	74

NSR/ ACT	Noise levels in dB(A)																					
	E.1	E.2	E.3a	E.3b	E.4	F.1	F.2	F.3a	F.3b	F.4	G.1	G.2	G.3a	G.3b	G.4	H.1	H.2	H.3a	H.3b	H.4	I.1	J.1
L2	56	45	46	56	56	56	44	45	55	55	55	44	45	55	55	55	43	44	54	54	48	43
L3	57	46	47	47	47	57	45	46	46	46	56	45	46	46	46	55	44	45	45	45	51	44
L4	57	46	46	56	56	56	45	46	56	56	56	45	45	55	55	55	44	45	55	55	39	44
L5	53	41	42	42	42	52	41	42	42	42	52	41	42	42	42	52	41	42	42	42	33	39
M1	61	49	50	60	60	60	49	50	60	60	59	48	49	59	59	58	47	48	58	58	50	49
M2	70	59	60	65	65	74	63	64	64	64	68	56	57	62	62	62	50	51	61	61	44	56
M3	63	52	53	53	53	63	52	52	52	52	62	51	52	52	52	62	50	51	61	61	37	49
M4	63	52	53	63	63	63	52	53	63	63	63	51	52	62	62	62	51	52	57	57	36	48
M5	80	69	70	69	69	78	66	67	67	67	71	59	60	65	65	69	58	59	64	64	44	73
M6	90	79	80	78	78	87	75	76	75	75	83	71	72	72	72	80	68	69	69	69	39	72
M7	70	59	60	70	70	83	71	72	72	72	80	68	69	74	74	85	73	74	74	74	37	62
M8	61	50	50	60	60	60	49	50	60	60	60	48	49	59	59	59	48	49	54	54	48	47
M9	70	59	60	65	65	64	53	54	64	64	63	52	53	62	62	62	51	51	56	56	51	57
M10	65	54	55	65	65	64	53	54	64	64	63	52	53	58	58	62	51	52	52	52	40	51
M11	64	53	54	54	54	64	52	53	53	53	63	52	53	53	53	62	51	52	52	52	38	50
M12	82	71	72	71	71	80	68	69	69	69	67	56	57	67	67	66	54	55	65	65	41	69

Table 4.29 Exceedance of ANL for Period 1 for the Ma Wan Viaducts - With Mitigation Methods A, B and C

NSR\ ACT	Noise levels in dB(A)																			
	A.1	A.2	A.3a	A.3b	A.4	B.1	B.2	B.3a	B.3b	B.4	C.1	C.2	C.3a	C.3b	C.4	D.1	D.2	D.3a	D.3b	D.4
L2	54	47	48	58	58	53	47	47	57	57	53	46	46	56	56	52	46	46	56	56
L3	55	49	49	59	59	54	48	48	58	58	54	47	47	47	47	53	46	47	47	47
L4	55	48	48	58	58	54	47	48	58	58	53	47	47	57	57	53	46	46	56	56
L5	49	43	43	43	43	49	43	43	43	43	49	42	42	42	42	48	42	42	42	42
M1	58	52	52	62	62	58	51	52	62	62	57	51	51	61	61	61	55	55	60	60
M2	68	59	59	69	69	65	58	59	68	68	63	57	57	67	87	62	56	56	66	66
M3	58	51	52	62	62	58	52	52	62	62	59	52	52	62	62	59	52	52	52	52
M4	57	50	51	51	51	57	51	51	51	51	58	52	52	52	52	58	52	52	52	52
M5	83	77	77	76	76	87	81	81	78	78	83	78	77	76	75	78	72	72	72	72
M6	73	66	87	66	66	75	89	69	69	69	78	72	72	71	71	82	76	76	75	75
M7	59	52	53	58	58	60	54	54	59	59	62	55	56	65	65	63	57	57	67	67
M8	57	51	51	61	61	57	51	51	61	61	57	51	51	61	61	56	50	50	60	60
M9	68	61	61	66	66	68	61	62	66	66	67	61	61	66	66	66	60	60	65	65
M10	61	55	55	65	65	62	55	55	65	65	61	55	55	65	65	61	54	55	65	65
M11	59	52	53	63	63	59	53	53	58	58	60	53	54	58	58	60	53	54	58	58
M12	76	70	70	70	70	79	73	73	72	72	81	75	75	74	74	80	74	74	73	73

- 4.24 -

NSR\ ACT	Noise levels in dB(A)																					
	E.1	E.2	E.3a	E.3b	E.4	F.1	F.2	F.3a	F.3b	F.4	G.1	G.2	G.3a	G.3b	G.4	H.1	H.2	H.3a	H.3b	H.4	I.1	J.1
L2	51	45	45	55	55	51	44	45	55	55	50	44	44	54	54	50	43	44	54	54	41	44
L3	52	46	46	46	46	52	45	45	45	45	51	45	45	45	45	51	44	44	44	44	44	45
L4	52	46	46	56	56	51	45	45	55	55	51	45	45	55	55	50	44	44	54	54	32	44
L5	48	41	42	42	42	48	41	41	41	41	47	41	41	41	41	47	41	41	41	41	26	40
M1	56	49	50	60	60	55	49	49	59	59	54	48	48	58	58	54	47	47	57	57	43	49
M2	65	59	59	64	64	69	63	63	63	63	63	56	57	62	62	57	50	51	61	61	37	57
M3	58	52	52	52	52	58	52	52	52	52	57	51	51	51	51	57	50	50	60	60	30	50
M4	58	52	52	62	62	58	52	52	62	62	58	51	52	62	62	57	51	51	56	56	29	50
M5	75	69	69	69	69	73	66	67	66	66	66	59	60	65	65	64	58	58	63	63	37	73
M6	85	79	79	77	77	82	75	76	75	75	78	71	72	71	71	75	88	69	68	65	32	72
M7	66	59	59	69	69	78	71	72	71	71	75	68	69	73	73	80	73	74	73	73	30	66
M8	56	50	50	60	60	55	49	49	59	59	55	48	48	58	58	54	48	48	53	53	41	48
M9	65	59	59	64	64	59	53	53	63	63	58	52	52	62	62	57	51	51	56	56	44	57
M10	60	54	54	64	64	59	53	53	63	63	58	52	52	57	57	57	51	51	51	51	33	52
M11	59	53	53	53	53	59	52	53	53	53	58	52	52	52	52	57	51	51	51	51	31	51
M12	77	71	71	71	71	75	68	69	68	68	63	56	56	66	66	61	54	55	64	64	34	69

Note : Shaded figures are exceedance of 60 dB(A)

Table 4.30 Exceedance of ANL for Period 2 for the Ma Wan Viaducts - With Mitigation Methods A, B and C

NSR/ ACT	Noise levels in dB(A)																			
	A.1	A.2	A.3a	A.3b	A.4	B.1	B.2	B.3a	B.3b	B.4	C.1	C.2	C.3a	C.3b	C.4	D.1	D.2	D.3a	D.3b	D.4
L2	54	47	48	58	58	53	47	47	57	57	53	46	46	56	58	52	46	46	56	56
L3	55	49	49	59	59	54	48	48	58	58	54	47	47	47	47	53	46	47	47	47
L4	55	48	48	58	58	54	47	48	58	58	53	47	47	57	57	53	46	46	56	56
L5	49	43	43	43	43	49	43	43	43	43	49	42	42	42	42	48	42	42	42	42
M1	58	52	52	52	62	58	51	52	62	62	57	51	51	61	61	51	55	56	60	60
M2	66	59	59	69	69	65	58	59	68	68	63	57	57	67	67	52	58	56	66	66
M3	58	51	52	62	62	58	52	52	62	62	59	52	52	62	62	59	52	52	52	52
M4	57	50	51	51	51	57	51	51	51	61	58	52	52	52	52	58	52	52	52	52
M5	83	77	77	76	76	87	81	81	78	78	83	76	77	75	75	78	72	72	72	72
M6	73	66	67	66	68	76	69	69	69	69	78	72	72	71	71	82	76	76	75	75
M7	69	52	53	58	58	60	54	54	59	59	62	56	58	65	65	63	57	57	67	67
M8	57	51	51	61	61	57	51	51	61	61	57	51	51	61	61	56	50	50	60	60
M9	68	61	61	66	66	68	61	62	66	66	67	61	61	66	66	66	60	60	65	66
M10	61	55	55	65	65	62	55	55	65	66	61	55	55	66	65	61	54	56	65	65
M11	59	52	53	63	63	59	53	53	58	58	60	53	54	58	58	60	53	54	58	58
M12	76	70	70	70	70	79	73	73	72	72	81	75	75	74	74	80	74	74	73	73

NSR/ ACT	Noise levels in dB(A)																					
	E.1	E.2	E.3a	E.3b	E.4	F.1	F.2	F.3a	F.3b	F.4	G.1	G.2	G.3a	G.3b	G.4	H.1	H.2	H.3a	H.3b	H.4	I.1	J.1
L2	51	45	45	55	55	51	44	45	55	55	50	44	44	54	54	50	43	44	54	54	41	44
L3	52	46	46	46	46	52	45	45	45	45	51	45	45	45	45	51	44	44	44	44	44	45
L4	52	46	46	56	56	51	45	45	55	55	51	45	45	65	55	50	44	44	54	54	32	44
L5	48	41	42	42	42	48	41	41	41	41	47	41	41	41	41	47	41	41	41	41	26	40
M1	58	49	50	60	60	55	49	49	59	59	54	48	48	58	58	54	47	47	57	57	43	49
M2	65	59	59	64	64	69	63	63	63	63	63	56	57	62	62	57	50	51	61	61	37	57
M3	58	52	52	52	52	58	52	52	52	52	57	51	51	51	51	57	50	50	60	60	30	50
M4	58	52	52	62	62	58	52	52	62	62	58	51	52	62	62	57	51	51	56	66	29	50
M5	75	69	69	69	69	73	66	67	66	66	66	59	60	65	65	64	58	58	63	63	37	73
M6	85	79	79	77	77	82	75	76	75	75	78	71	72	71	71	75	68	69	68	66	32	72
M7	66	59	59	59	69	78	71	72	71	71	75	68	69	73	73	80	73	74	73	73	30	68
M8	56	50	50	60	60	55	49	49	59	59	55	48	48	58	58	54	48	48	53	53	41	48
M9	65	59	59	64	64	59	53	53	63	63	58	52	52	62	62	57	51	51	56	56	44	57
M10	60	54	54	64	64	59	53	53	63	63	58	52	52	57	57	57	51	51	51	51	33	52
M11	59	53	53	53	53	59	52	53	53	53	58	52	52	52	52	57	51	51	51	51	31	51
M12	77	71	71	71	71	75	68	69	68	68	63	56	56	66	66	61	54	55	64	64	34	69

Note : Shaded figures are exceedance of 45 dB(A)

4.8.3 Impact during Period 2

Kap Shui Mun Bridge

Table 4.27 indicates that there will be widespread exceedance of the ANLs on Lantau and Ma Wan in Period 2 during construction of the Kap Shui Mun Bridge. The exceedance is predicted to be up to about 25 dB(A) for many activities and infrequently as much as 40 - 45 dB(A). Mitigation at source would not be adequate to reduce the noise to acceptable levels.

Ma Wan Viaducts

There is almost blanket exceedance of the ANLs on Ma Wan during the construction of the Ma Wan Viaducts. The exceedance is up to 45 dB(A) at receivers close to the construction work but reduces at those receivers further away.

There is also widespread exceedance on Lantau except at Tso Wan (L5).

4.8.4 Noise Mitigation at Receivers

The widespread exceedance of the ANLs during the restricted periods means that noise mitigation at the receivers must be applied if the works are to proceed 24 hours a day without causing excessive disturbance to the local residents. Sound insulation must therefore be considered for virtually all the properties on Ma Wan and the affected parts of North Lantau. This will require funding for the installation and operation of airconditioners or screens close to the receivers.

4.8.5 Conclusions and Recommendations

It will not be possible to carry out 24 hour working on the Ma Wan Viaducts or the Kap Shui Mun Bridge without causing excessive noise at dwellings on Ma Wan and Lantau. The level of noise is likely to be such that community action could be expected.

It is therefore recommended that sound insulation should be considered for these receivers. An exemption to the NCO has been granted on the same basis as the exemption for the Tsing Yi Bridge Contract, namely that noise insulation is installed at all affected properties and that the noise levels specified in Table 4.31 are not exceeded.

It should be noted that this level of noise is such that there must be some restriction on noise at source. A comparison of noise levels shown in Table 4.31 with those in Tables 4.26 to 4.30 shows that there would be some restrictions on the contractors method of working if these levels are to be specified in the construction contract.

Table 4.31 Maximum Noise Levels for the Kap Sui Mun/Ma Wan Viaducts Contract

Time Period	Ma Wan and North Lantau (Sam Po Tsui, Tai Chuen and Yi Chuen) dB(A)	North Lantau (Tso Wan and Ngong Shuen Au) and Ting Kau, Sham Tseng and Lung Tau dB(A)
Period 1	75	60
Period 2	70	55

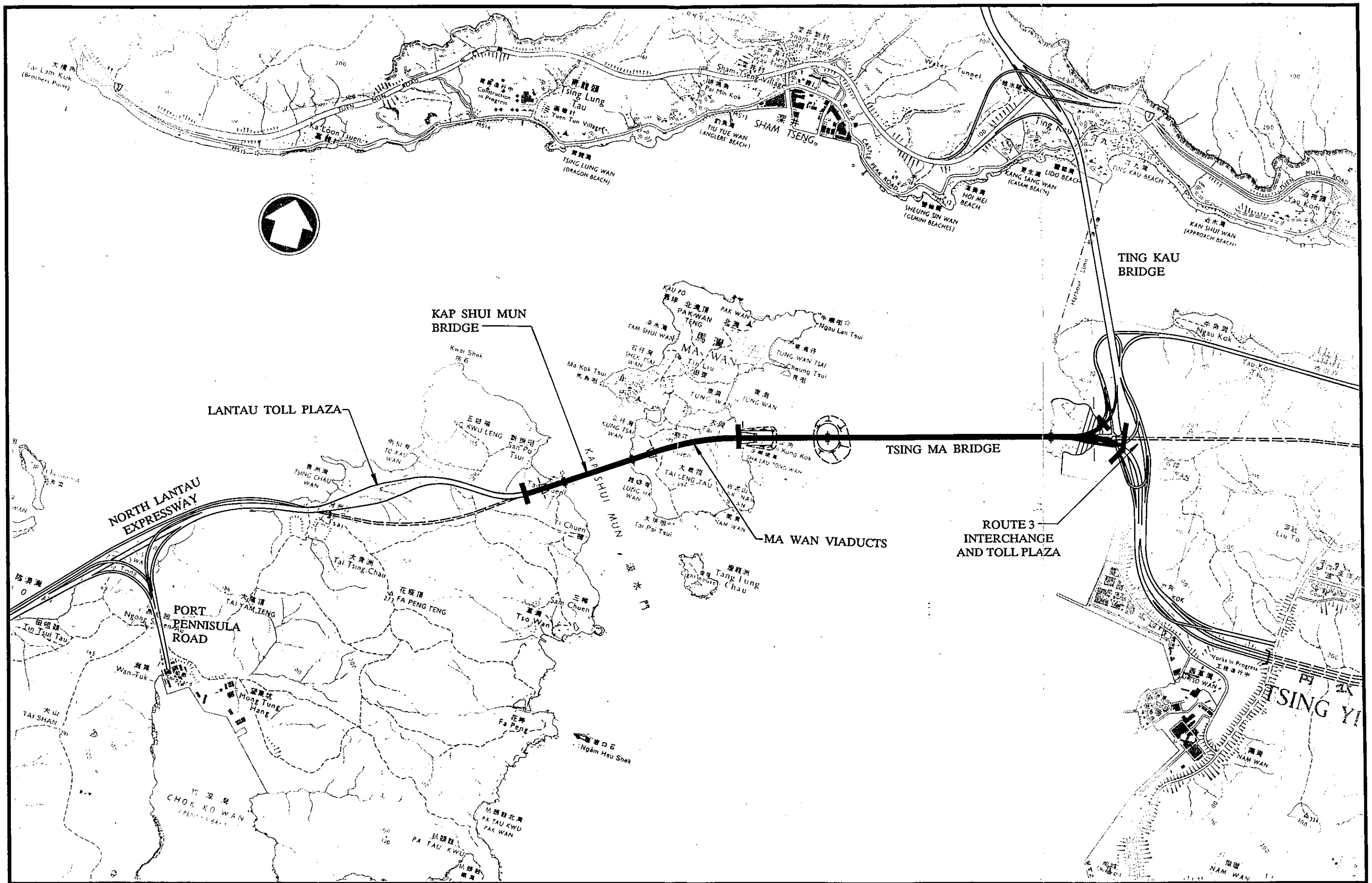

Mott MacDonald Hong Kong Ltd.
 in association with
 Harris & Sutherland (Far East)
 L. G. Mouchel & Partners (Asia)

LANTAU FIXED CROSSING

FIGURE 4.1

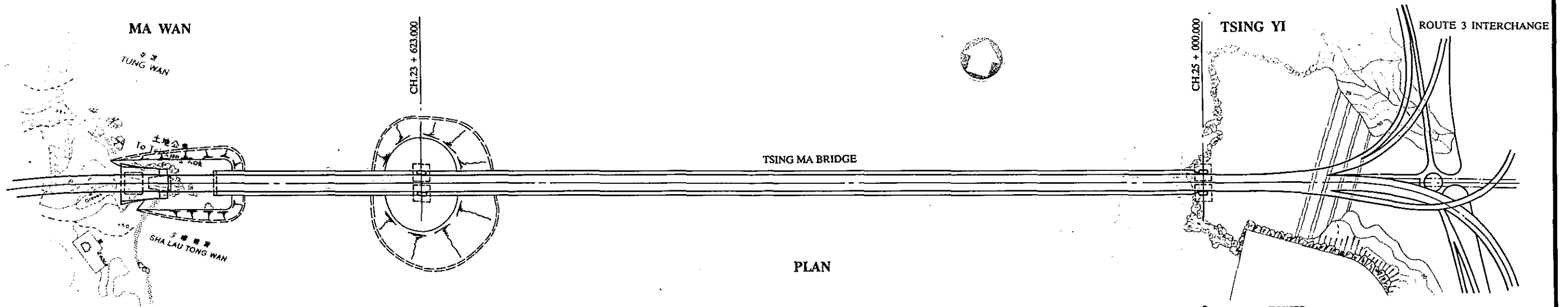

PLAN

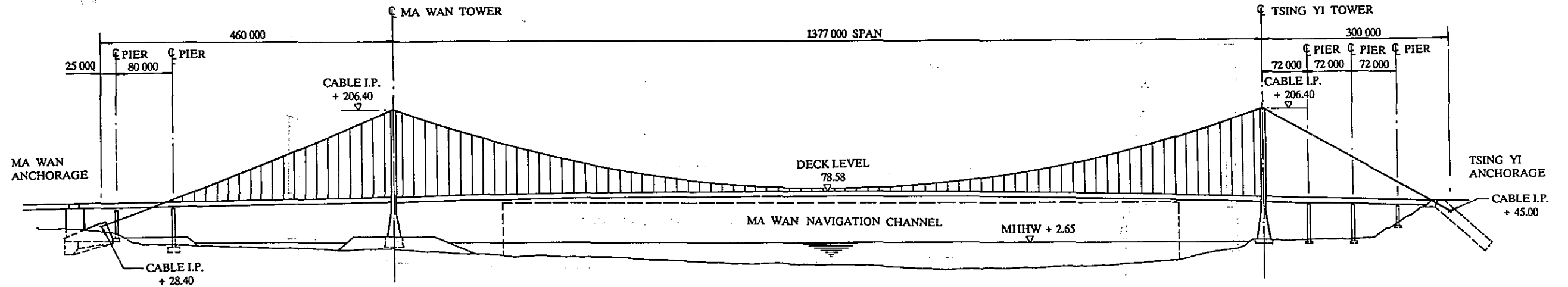

ELEVATION

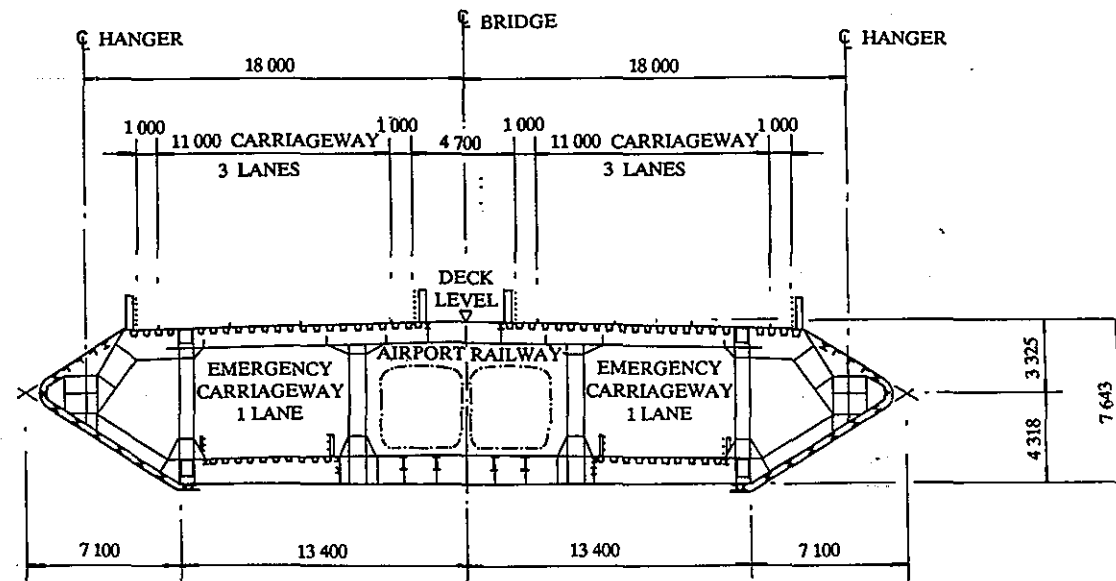
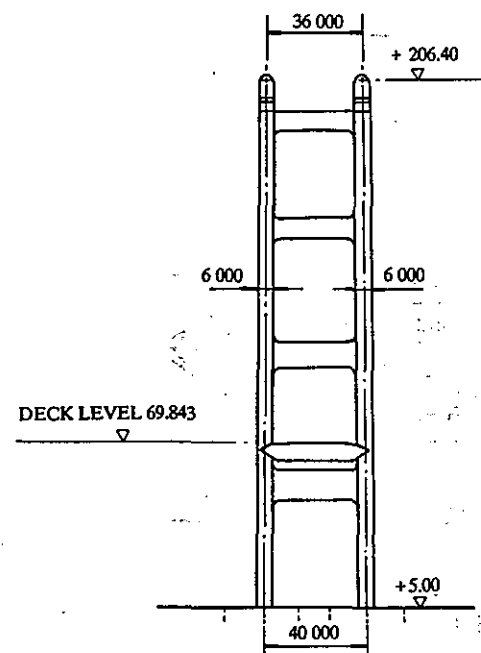

TYPICAL CROSS SECTION

Mott MacDonald Hong Kong Ltd.
in association with
Harris & Sutherland (Far East)
L. G. Mouchel & Partners (Asia)

TSING MA BRIDGE

FIGURE 4.2

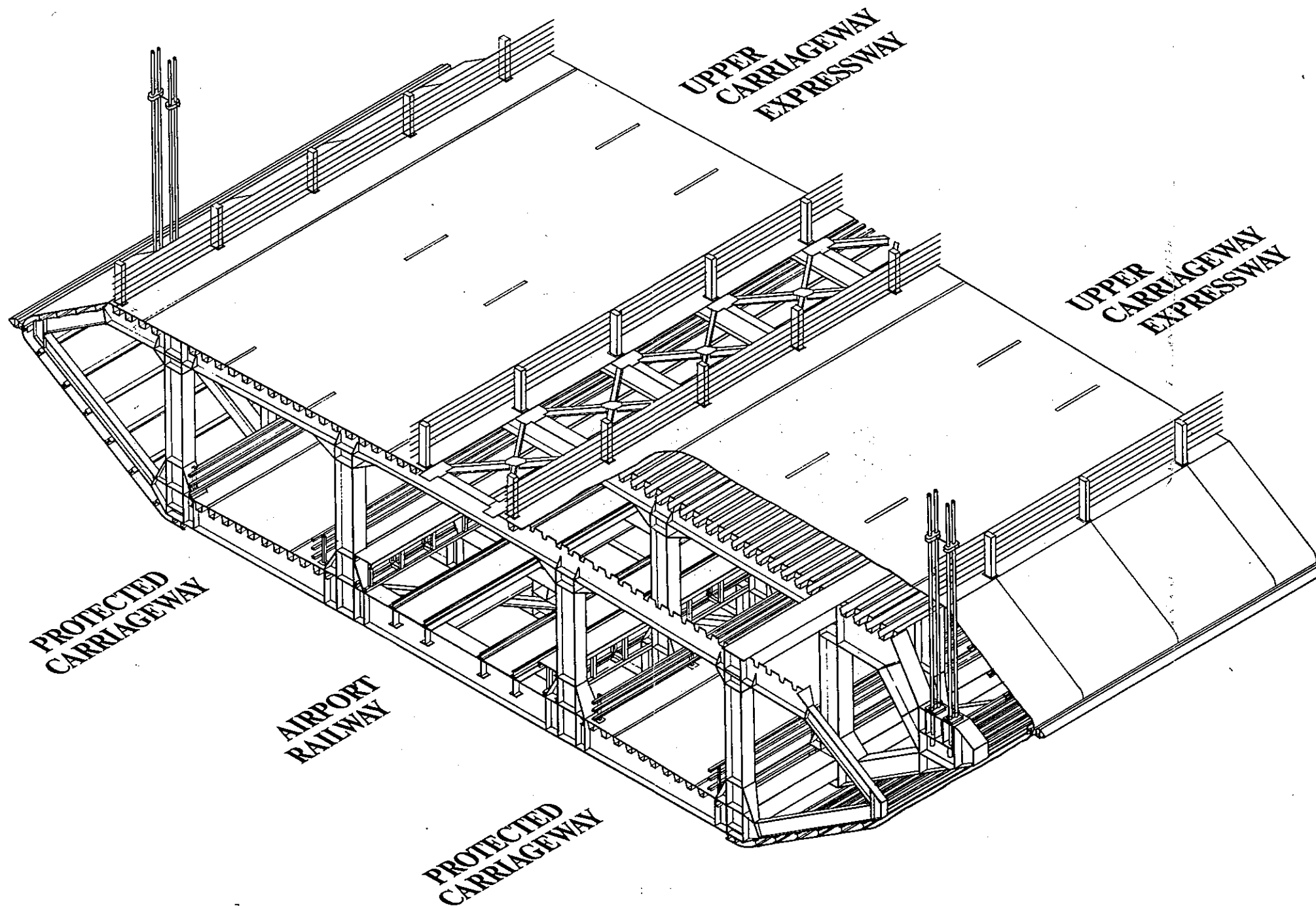

Mott MacDonald Hong Kong Ltd.
in association with
Harris & Sutherland (Far East)
L. G. Mouchel & Partners (Asia)

TYPICAL DECK LAYOUT

FIGURE 4.3

TSING MA BRIDGE

KEY CONSTRUCTION ACTIVITIES

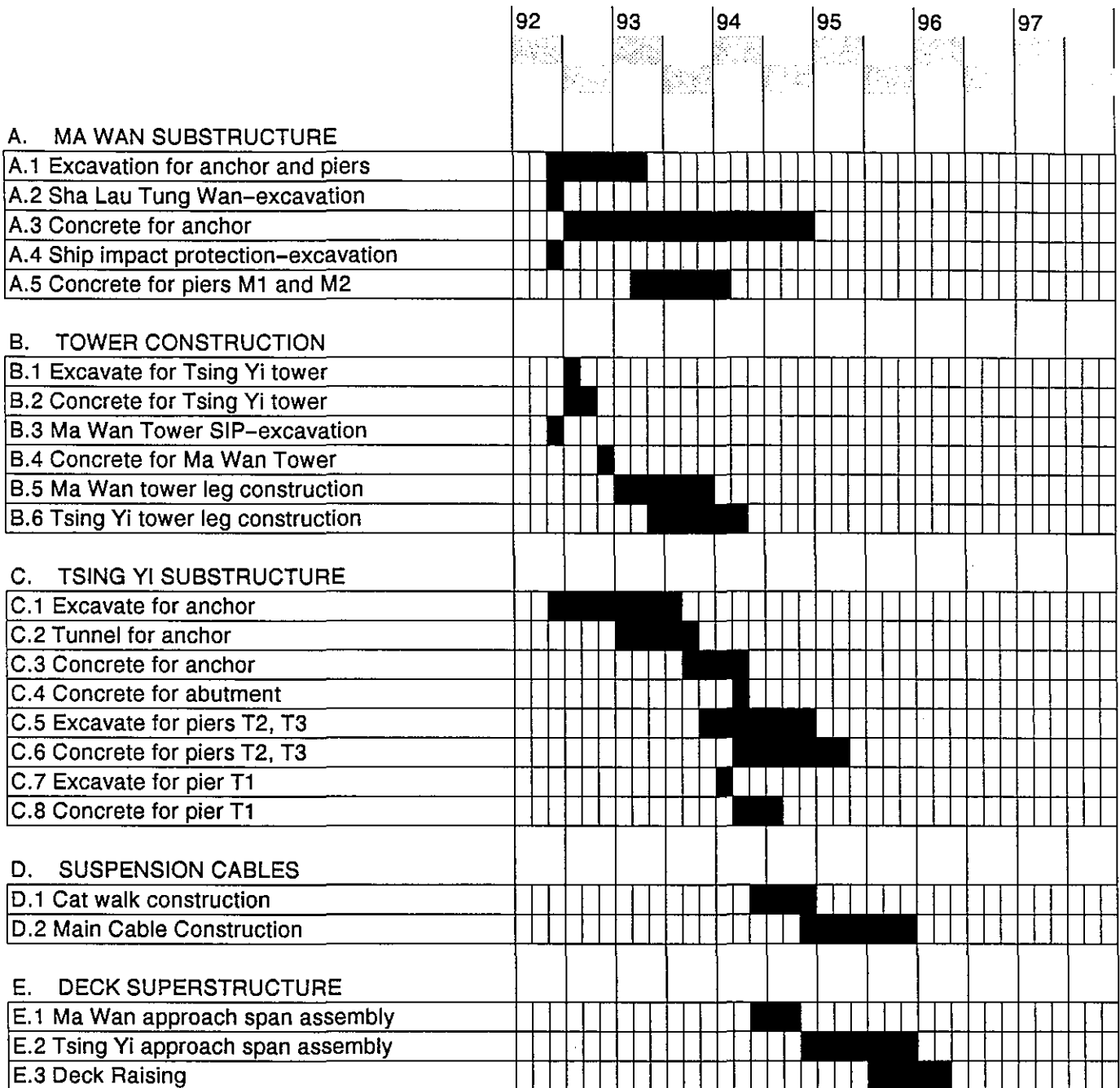

FIGURE 4.4
ASSUMED CONSTRUCTION PROGRAMME - TSING MA BRIDGE

KAP SHUI MUN BRIDGE

KEY CONSTRUCTION ACTIVITIES

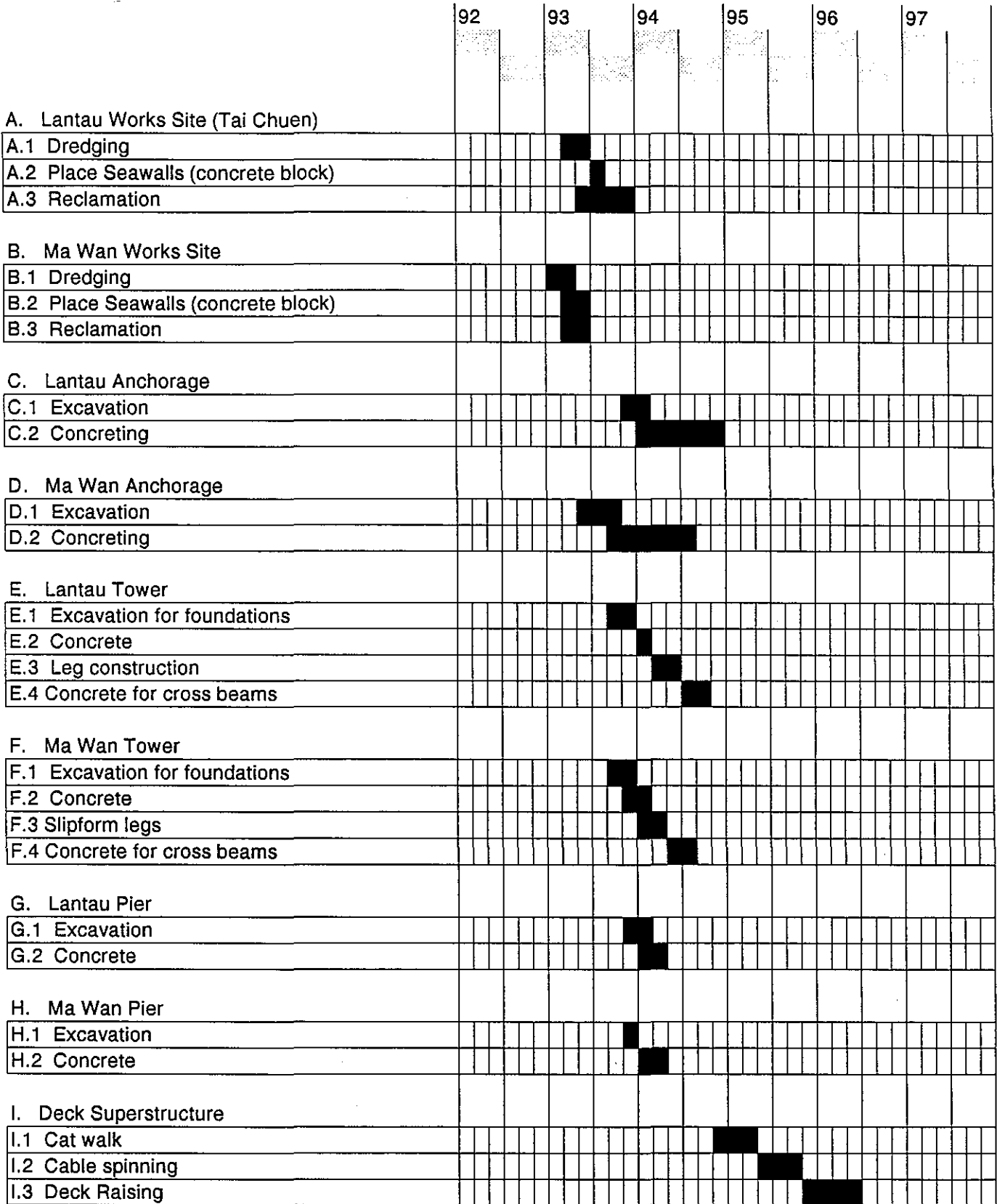

FIGURE 4.5

ASSUMED CONSTRUCTION PROGRAMME - KAP SHUI MUN BRIDGE

MA WAN VIADUCTS

KEY CONSTRUCTION ACTIVITIES

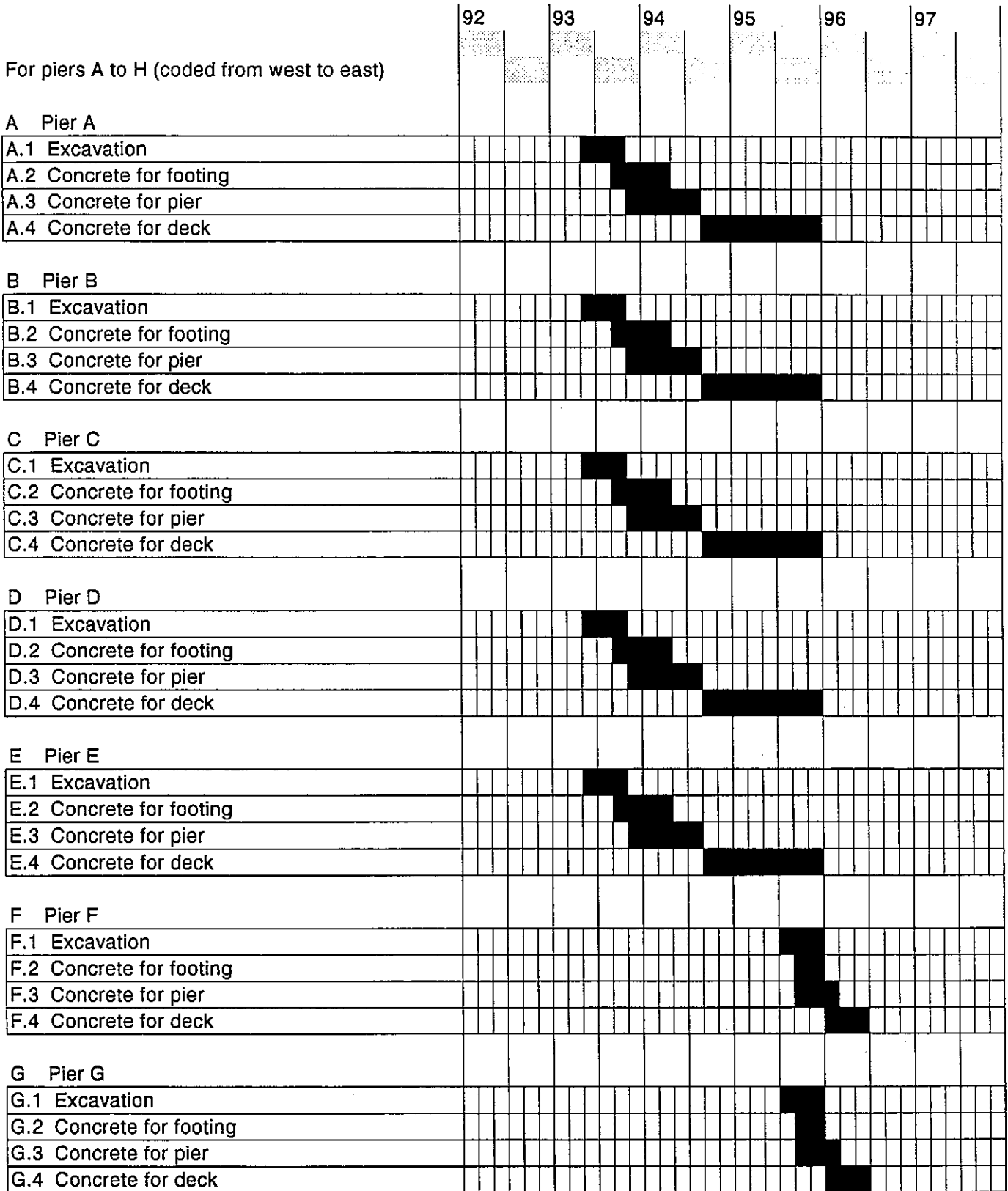

FIGURE 4.6a
ASSUMED CONSTRUCTION PROGRAMME - MA WAN VIADUCTS

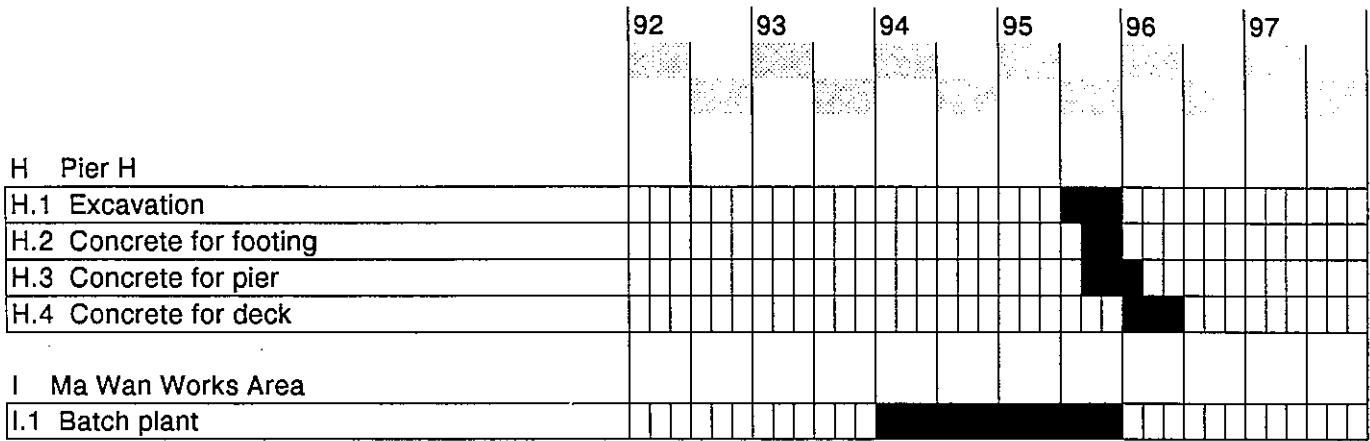

FIGURE 4.6b
ASSUMED CONSTRUCTION PROGRAMME - MA WAN VIADUCTS

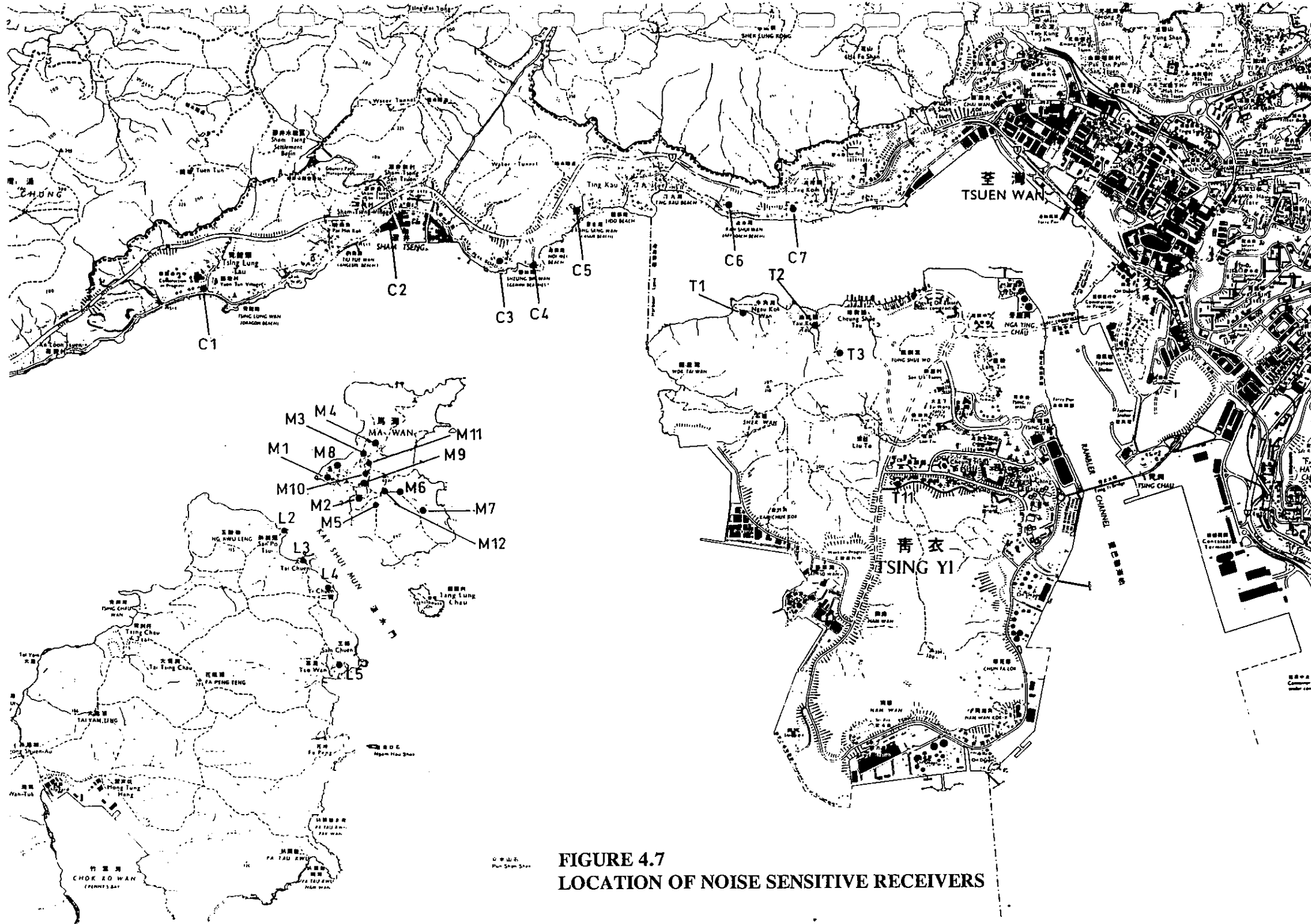

FIGURE 4.7
LOCATION OF NOISE SENSITIVE RECEIVERS

5. Railway Noise

5. RAILWAY NOISE

5.1 Introduction

The EPA considered noise from road traffic from trains crossing the LFC. It was concluded that road traffic should not cause significant impacts but that there could be an impact from noise from trains, partly due to noise transmitted through the structure. This effect could cause trains on the LFC to be noisier than similar trains running at-grade.

Provisions were included in the design of the Tsing Ma Bridge to reduce noise at source and the efficiency of these has been reviewed in the present stage of the assessment. The following sections describe the conclusions of this review and provisions made in the Kap Shui Mun Bridge and Ma Wan Viaduct contracts to minimise noise from trains.

5.2 Tsing Ma Bridge

5.2.1 Introduction

A trackform using 'Cologne Eggs' was specified in the tender documents for this bridge and this was subsequently analysed to determine its acoustic performance. The 'Cologne Egg' is a resilient rail fastener specially designed to reduce the vibrations which cause groundborne and secondary airborne noise. The vibration isolation is provided by an elliptical rubber pad bonded to the upper and lower surfaces of the fastener. The rubber pad takes both shear and compression loads and may be made stiffer or softer according to the application. This analysis showed that improvements were possible which would reduce the noise without detracting from the engineering performance of the bridge or trackform.

Each of the twin railway tracks across the Tsing Ma Bridge is intended to be carried on a waybeam structure the width of whose deck is fixed at 2.100m for weight and aerodynamic reasons. A study from British Rail Research (BRR) into the probable acoustic behaviour of such a structure in the context of the suspended deck of Tsing Ma Bridge was commissioned and in the light of the report resulting from that study four main options for the trackform on Tsing Ma Bridge have been considered. In order of development these are:

- Case I Direct fastenings using "Cologne Eggs" as specified in the Tender Specification;
- Case II "Cologne Egg" type baseplates on an inverted channel type steel plinth or rail bearer rigidly secured to the waybeam deck plate;
- Case III Plain baseplates on precast concrete blocks on resilient pads;
- Case IV As Case II but with plain baseplates and with the rail bearer separated from the waybeam deck plate by resilient bearings.

5.2.2 Trackform Options Considered

Case I

This consists of the design of the Trackform of the Tsing Ma Bridge as it was included in the Specification, featuring UIC 60 rail, "Cologne Egg" type baseplates, and UIC 33 guard rails. It is shown on drawings issued as part of the Tender documentation.

Case II

Whilst Case I complies with the previously agreed criteria, MTRC have expressed concern about its routine maintenance and inspection. This concern turns on the need to be able to retighten bolts and/or to detach one or more baseplates from the deck without going under the waybeams, even though this may not need to be done very frequently. Accordingly, in the Tender documentation a proposal was adopted to fasten down the "Cologne Egg" baseplates and the guard rail brackets by studs to a lower baseplate. By this means the "Cologne Egg" baseplates etc could be removed and replaced from on top of the deck. MTRC continued to express concern however that the studs could become a maintenance liability, and also that the lower baseplates were still proposed to be secured to the deck by bolts the heads of which are only accessible from beneath the track carrying structure.

An alternative which in principle solves these problems was discussed at meetings with MTRC on 15th and 16th July 1991, and forms Case II. The "Cologne Egg" baseplates in this proposal are fixed to a secondary system of supports (ie a rail bearer), by through bolts rather than studs, and are completely accessible from the track. The rail bearers are seen as an integral part of the bridge deck which should never need to be interfered with by track maintenance staff. By the same token, the holding down bolts for the rail bearers, although of necessity passing through the deck plate, are protected from accidental damage and should not require any more attention during the life of the bridge than any other structural fastening. This scheme is shown on Figures 5.1 and 5.2.

For such a scheme to be possible it was necessary to confirm that:

- (a) additional constructional depth was available for the trackform over and above the 300mm originally specified, within the limitations of the main bridge deck design; and
- (b) additional weight could be carried by the structure as a whole.

This was confirmed, and the scheme developed included "Cologne Egg" type baseplates as in Case I, supported on the upper surface of a rail bearer in the form of an inverted channel formed from welded steel plates.

No change from Case I was required in principle to the form of guard rail or guard rail supporting bracket, and the assembly was shown to be able to be adequately insulated for signalling and stray current protection.

Case III

Detailed investigation of the potential acoustic behaviour of the track and bridge indicated that significant noise energy would be transmitted into the main bridge structure in both Case I and II. This, coupled with the knowledge that extra weight and depth were available led to the development of Case III which incorporates what are considered to be the best noise attenuation measures possible within the constraints of the design of the suspended structure of the Tsing Ma Bridge. It consists, of;

- (a) baseplates secured by anchor bolts cast or screwed into concrete blocks long enough to support two adjacent baseplates under one rail;
- (b) gauge maintained by two encastre tie bars per block;

- (c) blocks supported on resilient configured or multi-cellular rubber pads nominally 40mm thick, and restrained from lateral and longitudinal movement by vertical rubber pads and steel retaining boxes permanently attached to the bridge deck; and
- (d) similar arrangements for guard rails and guard rail supports as in previous schemes.

Figures 5.3 to 5.5 show two possible variants of this arrangement.

Case IV

The difficulties encountered in developing sound engineering details for Case III, led to consideration being given to a modification of the Case II design. In this modification, the rail bearer becomes a rectangular steel box with its bottom surface open. The space within the box is filled with concrete. The rail bearer supports non-resilient baseplates (based upon the BR PAN 6 baseplate), with an intermediate layer of insulation and steel packings for height adjustment. The rail bearers are carried on resilient bearings over each waybeam diaphragm and cross girder. The two lines of rail bearers are maintained at the spacing required to ensure correct track gauge by rigid tie bars aligned on alternate baseplate positions. The all-important lateral fixity is provided by a combination of the tie bars and locating brackets aligned on every third tie bar.

This arrangement means that the combination of the two rail bearers and tie bars of either track form a horizontal Veerendeel girder. To provide optimum acoustic separation of the rail bearers from the waybeams, resilient pads are provided between the rail bearers and the external locating brackets. Traction and braking forces are resisted by traction rods attached to braces at the mid points of each continuous length of rail bearer. The arrangement is shown in Figures 5.6 to 5.10.

5.2.3 Acoustic considerations

Methodology

Improved acoustic performance will depend on:-

- (a) increase track mass; and
- (b) isolation of the track from the bridge.

These depend on there being some flexibility in the design of the bridge as follows:

- (a) an increased track mass of 1.5 tonnes per metre run of the bridge, (0.75 tonnes per metre run of track), is possible; and
- (b) a track depth from bridge deck plate to rail head of 765mm was available rather than the originally specified 300mm.

Analysis

It was considered essential to obtain further advice before proceeding towards a tender addendum and therefore Rupert M. Taylor, Consultant in Acoustics, Noise and Vibration Control was commissioned to analyse and identify the trackform that would have the most benefit in reducing vibration input to the bridge and the consequent radiation of noise to the environment.

His work entailed the establishment of a simplified finite difference analysis model which takes account of the propagation of vibration along the track and into the suspended bridge deck and assesses the influence of discrete support of the rails.

The analysis assumed the same type of rolling stock as had been assumed for the previous work. A 17 tonne axle load and a maximum permissible vertical deflection of the rail of 4mm were assumed.

Preliminary findings confirmed earlier assessments to the effect that:

- (a) It is not possible to design a trackform which will completely prevent emission of additional noise from the bridge. This is because of the large number of potential resonance frequencies produced by the complex structural nature of the suspended bridge deck.
- (b) Significant noise reduction can be obtained by providing a trackform comprising elements as follows:
 - (i) rail;
 - (ii) relatively stiff rail pad (forming an upper spring);
 - (iii) baseplate and block (together forming an intermediate mass); and
 - (iv) thick and soft resilient pad (forming a lower spring).

The theoretical characteristic of such a system is that since the heavy intermediate mass on its soft lower spring support only reacts relatively slowly to forces imposed from above, if the force is periodically oscillating at a high frequency compared with the natural frequency of oscillation of the intermediate mass, these high frequency oscillations will be reflected back into the wheel rather than be transmitted downwards into the structure.

Results of analysis

This theoretical prediction was confirmed by the finite difference analysis, which was carried out for five basic types of trackform, viz:

- (a) Case I;
- (b) individual blocks under each baseplate, connected by cross ties;
- (c) continuous beams;
- (d) beams of varying length; and
- (e) double blocks (Case III).

Note that (c) and (d) are both effectively alternative ways of looking at Case IV.

The findings of the assessment (Appendix J) put the various alternatives in the following order of effectiveness in reducing the penetration of wheel/rail interaction noise to the bridge members:

- (a) Case III;
- (b) Case IV - (it may be noted that the performance appears to improve as the beam length is shortened, ie Case IV optimises when it becomes Case III);
- (c) Individual blocks under each baseplate, connected by cross ties. This configuration is problematical in the Tsing Ma context because the blocks have too many degrees of freedom which sets up large numbers of coupled natural frequencies above the fundamental vertical mass-spring resonance; and
- (d) Case I.

A significant feature in achieving good attenuation was the need to have thick soft side pads to prevent vibrations entering the substructure from rotation of the block about its own longitudinal axis.

5.2.4 Engineering Aspects

General Principles

The starting point for the analysis of any trackform is the necessity to comply with the following two principles:

- (a) Rail rollover, track gauge and longitudinal alignment must remain within the already established tolerances under the worst anticipated conditions of normal traffic operation. These conditions have recently been identified as full speed train operation with the straight track canted at 65mm due to the most unfavourable combination of wind and road traffic conditions; and
- (b) The track must remain serviceable under potential derailment or overturning conditions. It is to be noted that, whilst overturning due to excessive speed on the LFC bridge alignment is plainly impossible, it could occur as a result of vandalism, sabotage, or the penetration of the track compartment of the bridge by debris from an accident on the roadway.

Case II

The Case II scheme possesses many advantages. It achieves the object of accessibility; it uses only well proven devices; it allows as good a standard of control over gauge and alignment as was possible in any of the cases described; and it incorporates as much resilience as is compatible with any scheme which involves securing the baseplates directly and positively to the track base. Its disadvantage is that it will not isolate the trackform from the trackbed sufficiently to prevent resonance between vibrations produced at the wheel-rail interface, and various elements of the bridge structure, at relatively high frequencies in the audible range.

Faced with this situation it appeared prima facie that the only way to achieve worthwhile improvement in acoustic performance would be to allow the trackform to oscillate freely in the vertical plane, as is the case with ballasted track, without positive retention against vertical movement. Various non-ballasted trackforms have been designed on this principle including the SNCF twin-block sleeper version of non-ballasted track, known as the STEDEF system, and this is the principle behind Case III. It was possible to predict from an available model for vibration on two levels of resilience, that the efficiency of the system could be improved by making the weight of the block much larger, and this led to the proposal of a trackform in which two baseplates under one rail would be supported by the one large block.

Case III

When Case III was analysed with the principles outlined above in mind it was found that to prevent rail rollover and gauge widening a substantial encastre tie-bar would be necessary, and preliminary indications suggested that a Tee section of say 100mm by 100mm by 10mm would be required.

In order to satisfy the first principle, considerably more side restraint is needed than is concomitant with the thick soft side pads required for acoustic purposes. The acoustic performance of the double block assembly would be appreciably degraded if the side pads were sufficiently stiff to meet the stringent track alignment tolerances laid down.

In considering the implications of the second principle it was found that even with a rigid tie bar the resultant of the forces on the rail in the overturning configuration came too close to the outer edge of the block as originally conceived (Figures 5.3 and 5.4). To meet this difficulty consideration was given to making the block much shallower (see Figure 5.5) but it was considered impractical to give such a block the necessary bending strength.

A further problem was perceived in that the critical components of the acoustically preferred trackform are not at present commercially available. Considerable development work would be needed in order to arrive at pad designs which would be soft enough to meet the requirements for acoustic performance, whilst yet providing stability under track loading. The performance of the pads when saturated with water, and their durability are also matters for concern. Finally means must be found of manufacturing the blocks. The possibility exists that the engineering development of Case III may ultimately prove non-viable. It was considered that such a risk was not justifiable if there was any other possible way forward, and accordingly a compromise proposal has been examined in which a continuous or semi-continuous rail bearer is supported at intervals on discrete resilient pads. This proposal is Case IV.

Case IV

Permanent way engineering

From a permanent way engineering point of view Case IV presents a much more workable design than Case III. Rail rollover and gauge control are achieved by the use of rigid tie-bars as before. Since all the resilient pads (ie bearings and side supports) are so much smaller in aggregate area than with the double block scheme, and they are all in freely drained situations where they are unlikely to become waterlogged, it is anticipated that commercially available items would be applicable. The lateral strength and stability of the combination of rail bearers and tie-bars in Case IV on the 2.100 m wide waybeam deck is considered to be adequate, particularly since it is possible to take advantage of the cross girders to support external brackets.

Excellent control of braking/traction forces can be obtained without interfering with the acoustic performance of the arrangement.

The rail bearers are demountable for replacement or if access is required to the upper surface of the underlying deck plate, and all the resilient pads are in locations where they are immediately visible for inspection. Side pads will be removable without interfering with the rail bearers themselves.

Rail bearer design

Consideration has been given to the question whether a steel box filled with concrete should be specified, or whether a pretensioned prestressed concrete beam would be adequate. Steel and concrete is preferred for these reasons:-

- (a) it is easier to attach tie bars etc to a steel box than to a concrete beam; and
- (b) a steel box enables the units to be joined together to suit constructional requirements and/or to optimise acoustic considerations.

Construction

It is proposed that the railbearers will be fabricated in lengths nominally of 4.5 metres. They will be positioned on the deck plates before the latter are lifted from their fabrication bays and as part of the fixing process will be jointed into lengths which will be determined by a combination of acoustic and engineering optimisation.

Conclusion

The Case IV trackform has been selected as the best practical means of minimising noise from the structure and a Tender Addendum has been issued to incorporate this in the Contract.

5.3 Kap Shui Mun Bridge and Ma Wan Viaducts

5.3.1 Environmental Reference Scheme

The Kap Shui Mun Bridge and Ma Wan Viaducts will be contractor's designs and the approach to minimisation of noise adopted for the Tsing Ma Bridge cannot be used. The requirement for the tenderer's proposed design to be of a "quiet" form must therefore be set out in the tender documents.

One way to attempt to achieve this would be to include in the tender documents acceptable noise levels at various locations. The document would require the tenderers to submit an EIA predicting noise levels arising from their proposed designs. Unfortunately the value of such an EIA would be doubtful since, from our experience to date, such predictions would be based to a large degree on judgement and no two experts in the field are likely to agree entirely.

Tenderers themselves would have great difficulty estimating the noise that would be generated by their proposed structure and would face considerable uncertainty in developing their designs. Tender evaluation would be very complicated since it will be very difficult to assess the compliance with the noise levels defined in the tender. It is most likely that tenderers will use different approaches to the noise calculations and the tender evaluation could develop into a technical discussion on the validity of the different approaches. Quiet structures are likely to be more expensive than noisy structures and it is probable that contractors will go to great

lengths to demonstrate that their structures are quiet even if this proves not to be the case. It will be very difficult to refute such arguments given the uncertainty inherent in the calculations. Furthermore, a tender design when accepted on contract award cannot be altered without contract variation. If the change is required by the Employer, for whatsoever reason other than faulty design, the contractor will be entitled to compensation in time and money.

The usefulness of such predictions would be further in doubt since railway noise is likely to become a problem some years after opening of the Airport Railway when services start to reach saturation. The noise generated will be influenced by the choice of rolling stock, the actual operating procedures and the degree of maintenance carried on both the track and rolling stock by the operator. Thus while the operator may well maintain the highest standards it is doubtful that any action could be taken against the contractor should noise levels exceed those predicted at the time of tender.

As a solution to these difficulties the tender documents have included an Environmental Reference Scheme (ERS). This defines the scheme in relation to factors affecting the attenuation of train noise and requires that these aspects are included in the tenderer's proposals.

The ERS has been developed by making and refining outline engineering proposals for the scheme and checking predicted noise levels at sensitive receivers. The objectives of the ERS has been to design for noise levels which are the lowest that Government can expect to be achieved within practical engineering and cost criteria. The salient components of the ERS have been incorporated as Employer's requirements in the tender documents, in the form of description and report style drawings.

The fundamental advantage of the ERS approach is that a clear statement of Government's requirements has been included in the tender documents. This has been previously agreed within Government and the possibility of uncertainty during the preparation and evaluation of tenders will be reduced. In addition this approach is likely to result in a quieter structure as there will be no possibility of contractors 'manipulating' noise calculations.

5.3.2 Technical Decisions

The following technical decisions have been made in the development of the ERS.

Ma Wan Viaduct to be of concrete

An acoustically well designed large concrete railway bridge will be quieter than a steel one.

Of the three structures of the Lantau Fixed Crossing the Ma Wan Viaduct is the most noise-sensitive. It will be close to the little village of Lau Fa and will not be far from Ma Wan township. It is proposed that Lau Fa Village will be resumed.

The design is expected to be based on spans of 50m or so. At such spans the costs of a steel viaduct and a concrete one will probably not be dissimilar.

The contract therefore specifies that the viaducts shall be of concrete.

Choice of trackslab

It is very difficult to design a large railway bridge so that if it vibrates as a whole some individual components will not resonate noisily. In the case of Ma Wan Viaducts and Kap Shui Mun Bridge, both of which will have large panels to shield the lower deck from high winds, it was found not to be practicable to draw up design specification clauses which would prevent such noise emission. It was therefore necessary to arrange for the track to be vibrationally isolated from the rest of the structures by the provision of a fairly heavy "floating" track support system.

Supporting members to be defined

When a railway bridge rumbles the vibration originates in the members which support the trackform, so their design is acoustically important, even if they are isolated as much as possible from the trackform. In a big bridge their design can be a balance between cost and acoustic performance. It is also important for other reasons, e.g. it affects inspection and maintenance of the trackbed.

Accordingly, the contract not only specifies the design of the slabs themselves, it also controls the design of the members supporting them.

Design of trackslab and supporting members

The existing MTR system uses trackslabs successfully in tunnels. Space requirements in the tunnels necessitate the use of slabs resting on bearings which themselves are mounted directly onto the tunnel invert concrete. As a result the tunnel invert, the bearings and the underside of the slabs cannot be inspected. A large number of bearings are used so that an isolated bearing failure will not have serious consequences.

Ma Wan Viaducts and Kap Shui Mun Bridge do not have stringent height restrictions so it will be possible to design the slabs to have space beneath. The space will allow:

- (i) a high quality of bearing installation and first inspection;
- (ii) easy routine inspection of all parts; and
- (iii) straightforward maintenance (including steelwork painting).

Support for the bearings could be provided by longitudinal or transverse walls, either of which could be designed by the Contractor to function as useful structural members. Transverse beams were chosen because they will make access much easier. Their spacing and vibrational characteristics were limited to control resonance.

The weights of the floating slabs themselves were chosen to give good acoustic performance, but without losing sight of cost implications.

Quality of track maintenance

The level of noise emitted will be sensitive to the quality of track maintenance in general and the avoidance of corrugation in particular. High standards of track maintenance are a straightforward means of keeping down noise levels.

The calculations upon which this paper is based assume a high standard of track maintenance - higher than perhaps would always be carried out on a railway of this type. In particular they assume that the rails will be lightly ground monthly to forestall incipient corrugation. Any reduction in the assumed maintenance standards could result in an increase in noise emission.

5.3.3 Predicted Noise Levels

The following predictions are of noise due to trains. They do not include ambient noise, noise from road traffic using the LFC or noise from aircraft using the new airport.

The computer model showed that trains will cause both bridges to give out unpleasant low frequency noise. Such noise is often perceived as being more troublesome than noise at higher frequencies. However it also indicated that, in terms of L_{Aeq24h} :

- (a) Kap Shui Mun Bridge may be only about 2 dB(A) noisier than the base case of trains on an embankment (ie excluding any structural effects).
- (b) Ma Wan Viaducts may make about the same amount of noise as the base case.

The predicted noise levels are shown in Table 5.1. The locations of the receivers are shown on Figure 5.11. These assume that only one train would be on the bridge at one time. If two trains crossed the noise at any receiver would increase by upto 3 dB(A) although the L_{eq} would not change.

The predictions have been made using the following assumptions:-

- (a) the Tsing Ma Bridge will have resilient rail bearers;
- (b) the Ma Wan Viaducts will be of concrete, with concrete trackslabs;
- (c) the Kap Shui Mun Bridge will be of steel with concrete trackslabs;
- (d) train frequencies will be as in the Airport Rail Feasibility Study for 2011; and
- (e) rolling stock would have dynamic mass and suspension characteristics (i.e. stiffness) similar to that presently used on the MTR.

Table 5.1 Predicted Facade Noise Levels

Property			Amount of Noise dB(A)			
No.	Location	Distance from bridge	L _{max}	L _{eq24h}	Daytime L _{eq(30 min)}	Nighttime L _{eq(30 min)}
1	Lau Fa	20m	82	67	70	64
2	Lau Fa	45m	80	65	68	61
3	Lau Fa	67m	77	63	66	60
4	Lau Fa	75m	77	63	66	60
5	West coast	150m	71	60	63	57
6	Ma Wan town	235m	77	63	71	65
7	East coast	75m	78	64	70	64
8	Tin Liu village	360m	73	61	64	58
9	East coast	335m	74	62	71	63
10	San Po Tsui	235m	71	60	63	57

The above predictions are subject to three sources of inaccuracy:

- (a) unavoidable approximations in the mathematical modelling;
- (b) incomplete knowledge of the form that the bridges will take; and
- (c) incomplete knowledge concerning railway operation and maintenance.

Taking these in turn

- (a) the mathematical techniques are fairly new and their applicability to railway bridges is unproven. Nevertheless they have been applied successfully in other branches of engineering. They were recently applied to an existing railway bridge for which full details of construction, rail condition, rolling stock, railway operation etc. were known. In that case the predictions were correct to ± 3 dB above 100 Hz;
- (b) the bridges will be designed by the Contractor. His designs will be constrained by the ERS, but the Specification is a compromise between acoustic ideals and reasonable, practicable, contractual stipulations. Numerous decisions taken by the Contractor within the constraints of the Specification could each make differences of 2-3 dB;
- (c) the largest source of error lies in the assumptions concerning railway operation and maintenance. The BRR report points out that corrugation alone can increase noise by 20 dB.

These could increase or decrease the tabulated levels. If it is conservatively assumed that the combined effect of the many unknown and/or uncontrollable factors would be to increase the tabulated values by a few decibels, then it would appear that the passage of trains will result in L_{eq24h} levels of 70 dB or more at houses within 100m of the viaduct and in excess of 65 dB at some properties on the southern side of Ma Wan township and elsewhere. However, the sound levels will be far lower than they might have been -- at the majority of the houses most affected by the crossing L_{eq24h} may well be 14 dB or so better than if the hypothetical bridge considered in previous reports had been built.

5.3.4 Conclusions

The conclusions concerning Kap Shui Mun Bridge and Ma Wan Viaducts are that:

- (a) the level of noise emitted by a large railway bridge can not be predicted with confidence, but it is possible (although theoretically complex) to predict noise reductions;
- (b) it is difficult for the designer of a large railway bridge to control noise emission and it is even more difficult to do so in the case of a competitive design-and-build contract;
- (c) a method of achieving an acceptable, albeit imperfect, level of control has been developed. It depends largely on specifying in the contract the type of trackform and associated structure. It is considered to be the best practicable means of controlling train noise emission from the two bridges;
- (d) it has not been possible to prevent both bridges giving out low frequency noise during the passage of trains, but noise levels have been reduced considerably; and
- (e) computations indicate that the designs currently proposed would result in L_{Aeq24h} at the majority of the houses most affected being about 14 dB lower than would have been the case with the hypothetical bridge of the BRR report. Put another way, they indicate that at those houses, 25 trains crossing the bridges now proposed would sound as if they were together making about the same amount of noise as one train crossing the hypothetical bridge.

Clauses specifying the ERS which have been included in the tender documents are included in Appendix K. In addition the Contractor will be required to carry out a comprehensive acoustic analysis of his design.

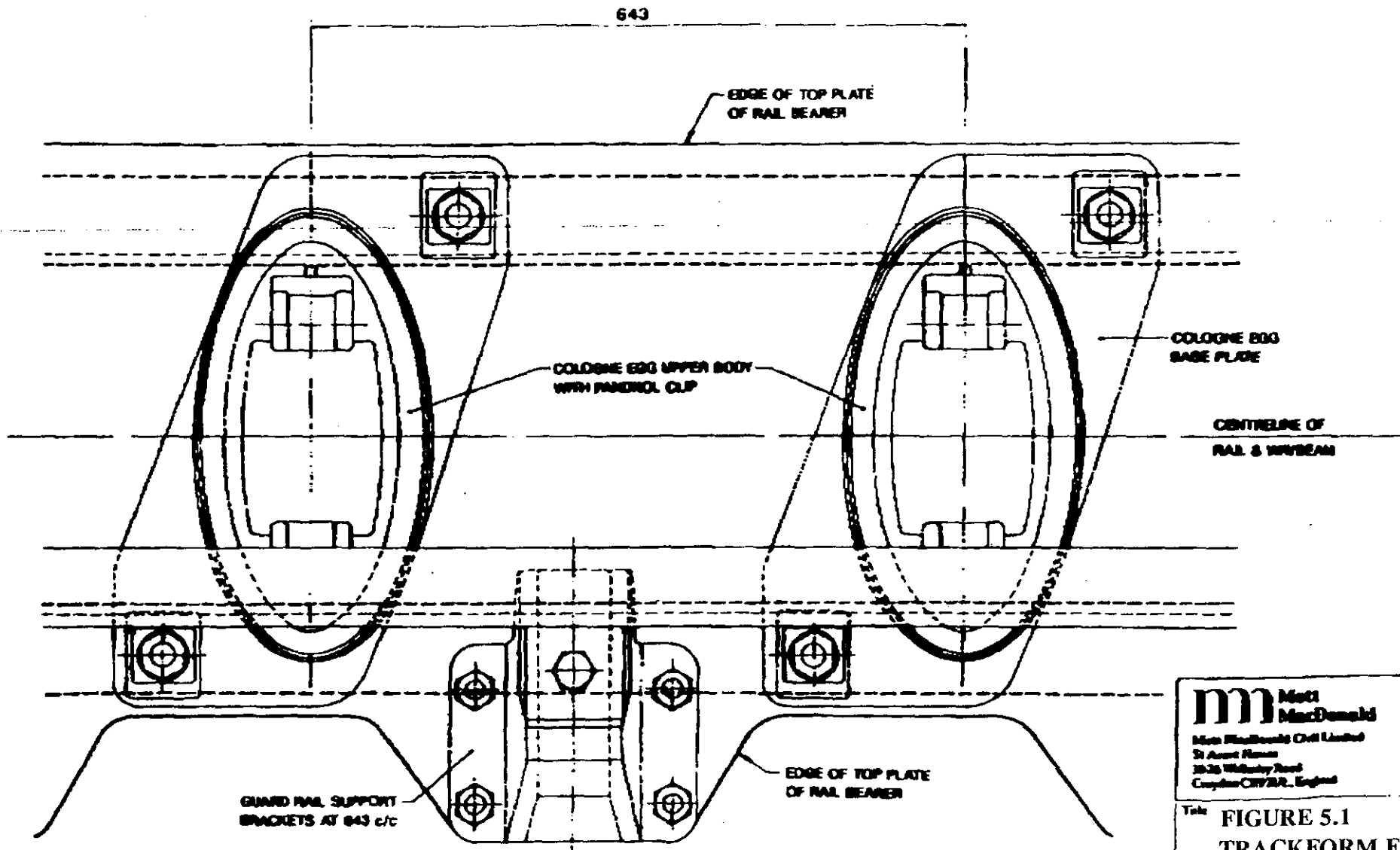



m Maci MacDonald
 Main Roadworks Civil Limited
 21 Azzurri Place
 20/20 Wilby Road
 Croydon CR7 2RL, England

Telephone 01-489 2044
 Fax 01-489 5785 / 01-489 2864
 Telex 95748 MOTTAV G

Title **FIGURE 5.1**
TRACKFORM FOR
TSING MA BRIDGE - CASE 1
PLAN

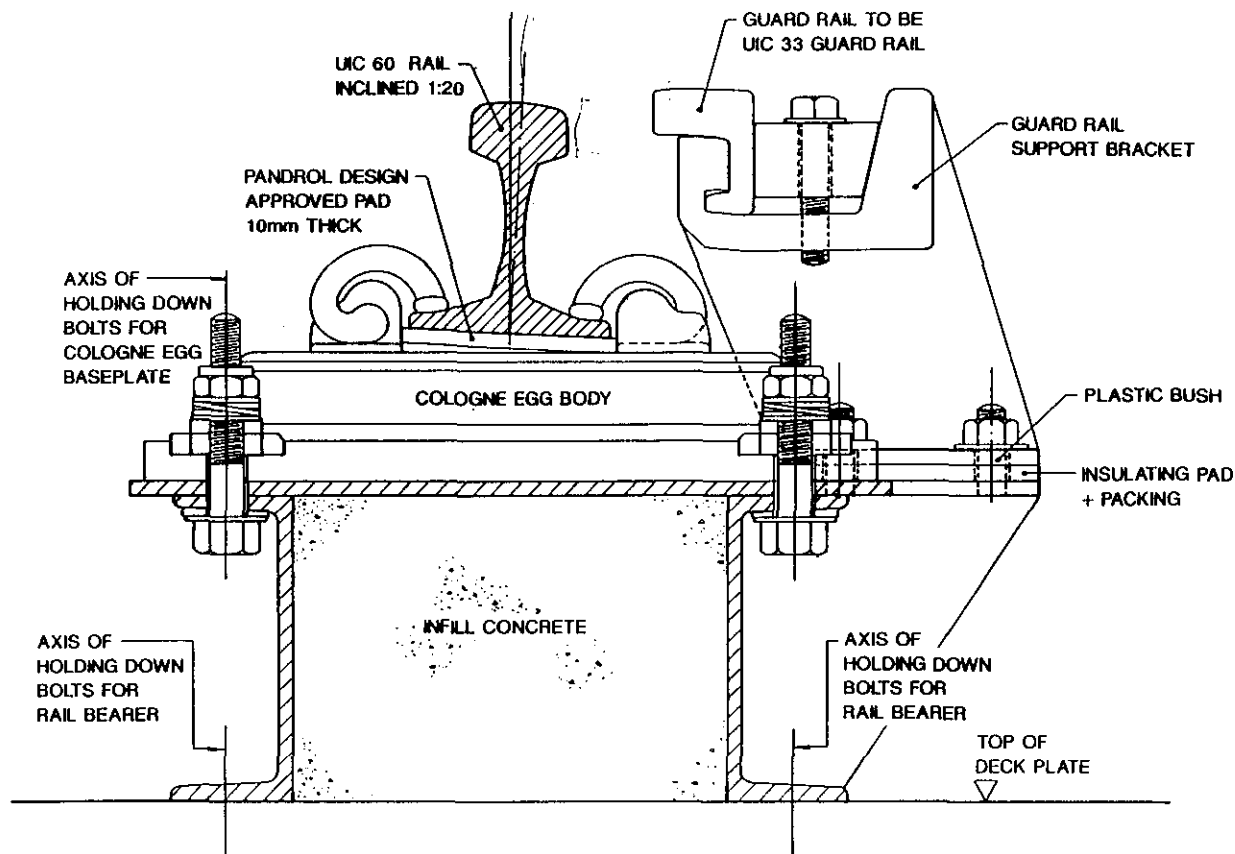
Drawn	Checked	Approved	Scale
Drawing			Rev



				
Mott MacDonald Civil Limited St Anne House 20-26 Wellesley Road Croydon CR9 2UJ, England				
			Telephone 01-686 5041 Fax 01-681 5706 / 01-688 1814 Telex 917241 MOTTAY G	
Title FIGURE 5.2 TRACKFORM FOR TSING MA BRIDGE - CASE II TYPICAL SECTION				
Date	Drawn	Checked	Approved	Scale
Drawing				Rev

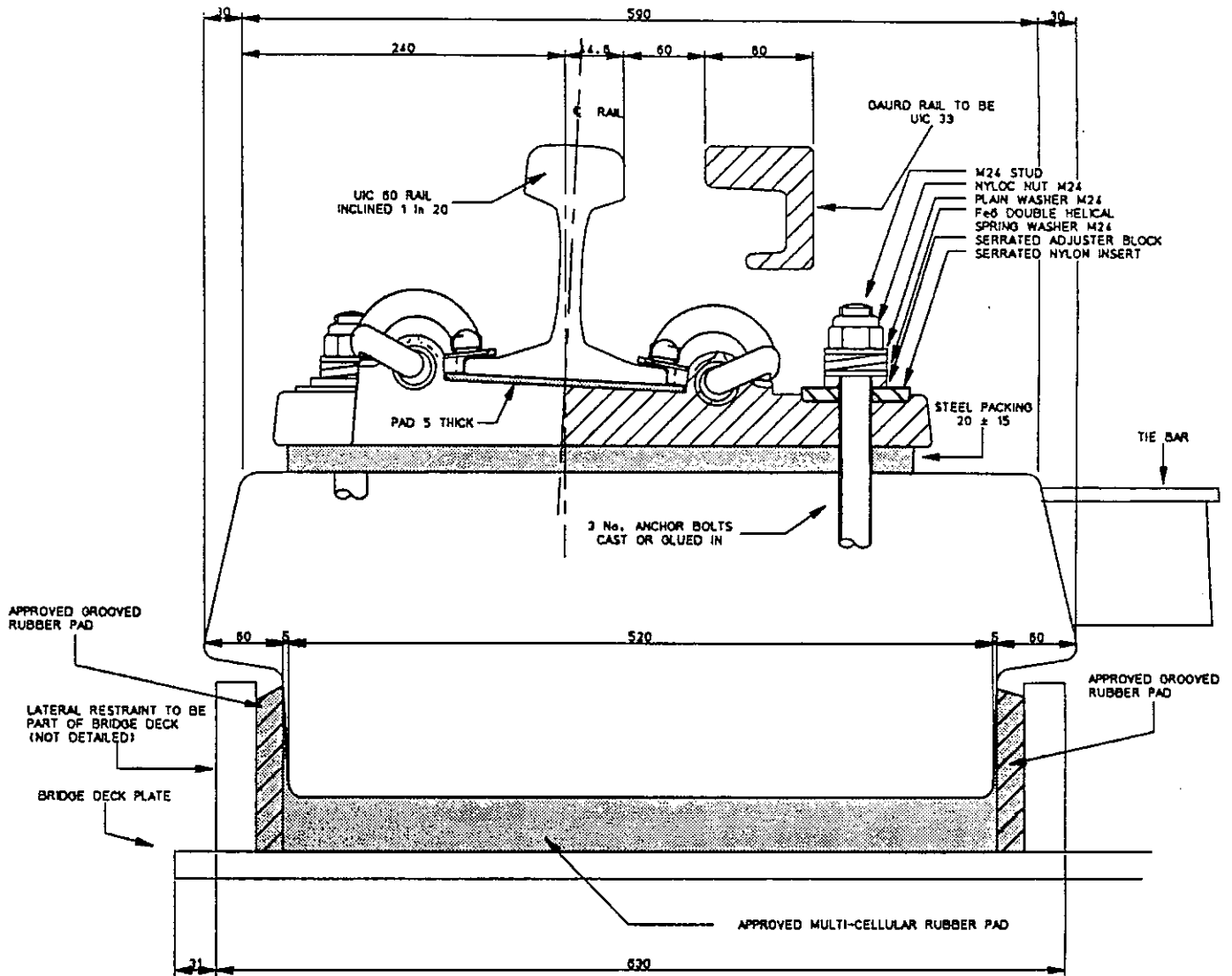

Title **FIGURE 5.3**
LANTAU FIXED CROSSING
PROPOSED BASEPLATE AND
BLOCK ASSEMBLY

m Mott
 MacDonald
 Mott MacDonald Civil Limited
 St Anne House, 20-26 Wellesley Road
 Croydon CR9 2UL, England

Telephone 081-686 6041
 Fax 081-681 5706 / 081-688 1814
 Telex 917241 MOTTAY G

Date	Drawn MFD	Checked	Approved	Scale 1 : 5	Drawing no. 3811/RT/0004	Rev
------	--------------	---------	----------	----------------	-----------------------------	-----

DRG:LBROJ.3811E20J0005.FGB.1.MFD/CAD.02SEP91.15.08.40

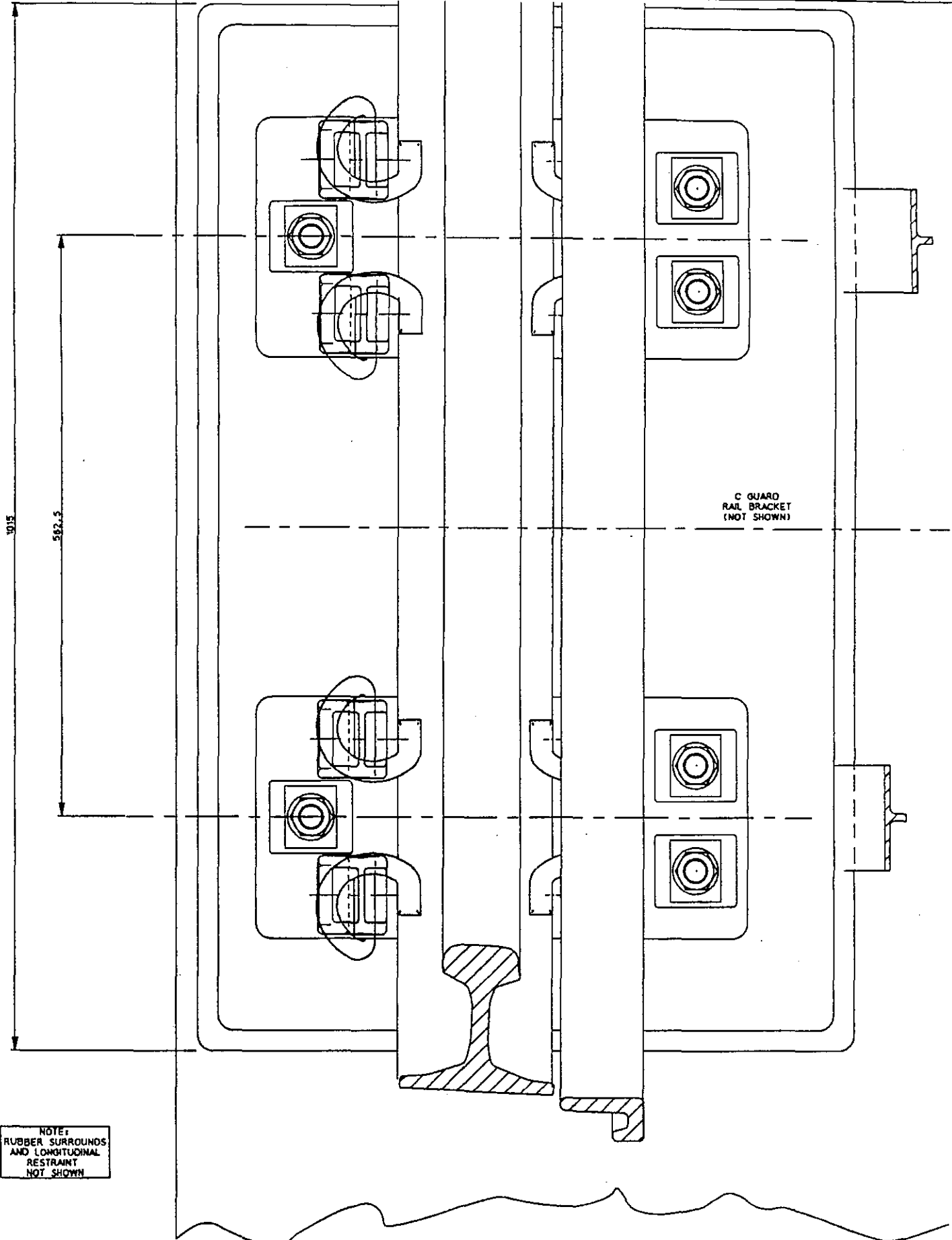

NOTE:
RUBBER SURROUNDS
AND LONGITUDINAL
RESTRAINT
NOT SHOWN

C GUARD
RAIL BRACKET
(NOT SHOWN)

Title FIGURE 5.4 LANTAU FIXED CROSSING PROPOSED BASEPLATE AND BLOCK ASSEMBLY					 Mott MacDonald Mott MacDonald Civil Limited St Anne House, 2026 Wellesley Road Croydon CR9 2UL, England		Telephone 081-686 6041 Fax 081-681 5706 / 081-688 1814 Telex 917241 MOTTAY G	
Date	Drawn MFD	Checked	Approved	Scale 1 : 5	Drawing no. 3811/RT/0005		Rev	

DR8-LB0J, 3A1E20]000A.FG3,1 MFD CAD - 07SEP91-12.59.30

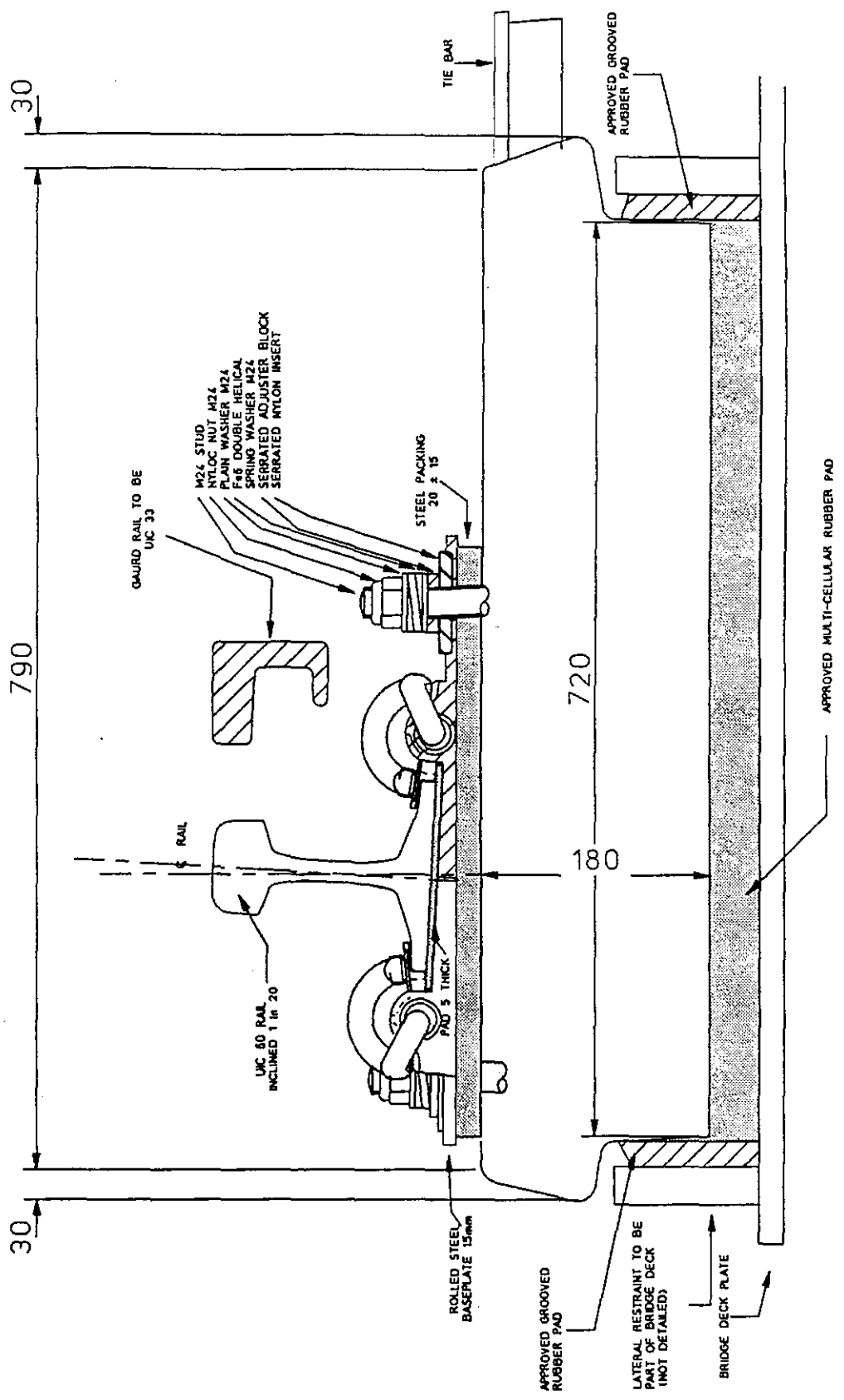

Title FIGURE 5.5
**LANTAU FIXED CROSSING
 PROPOSED BASEPLATE AND
 BLOCK ASSEMBLY**

m Mott
 MacDonald
 Mott MacDonald Civil Limited
 St Anne House, 20-26 Wellesley Road
 Croydon CR9 2UL, England

Telephone 081-666 5041
 Fax 081-681 5706 / 081-688 1814
 Telex 917241 MOTTAY G

Date	Drawn MFD	Checked	Approved	Scale 1 : 5	Drawing no. 3811/RT/0008	Rev
------	--------------	---------	----------	----------------	-----------------------------	-----

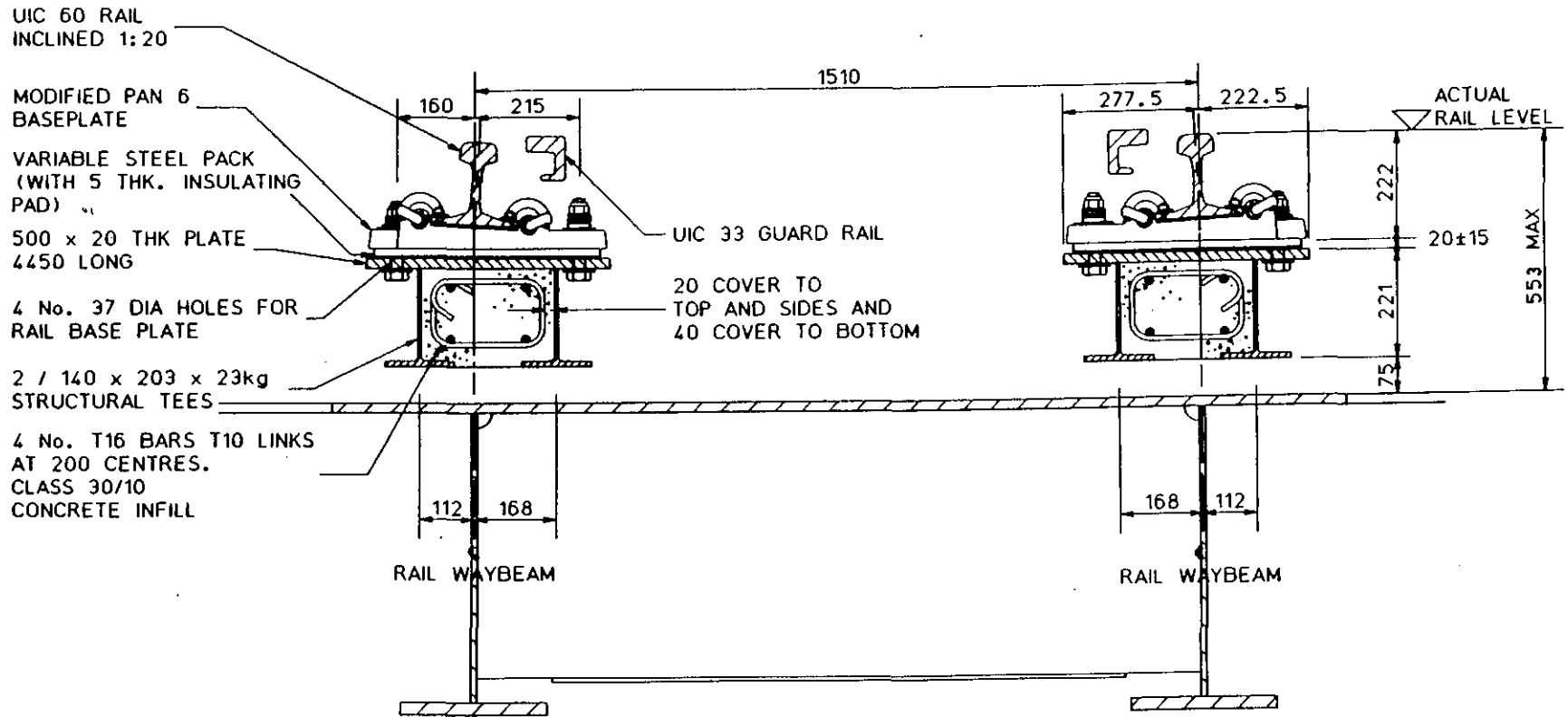

FIGURE 5.6
TYPICAL SECTION THROUGH RESILIENTLY MOUNTED RAIL BEARER

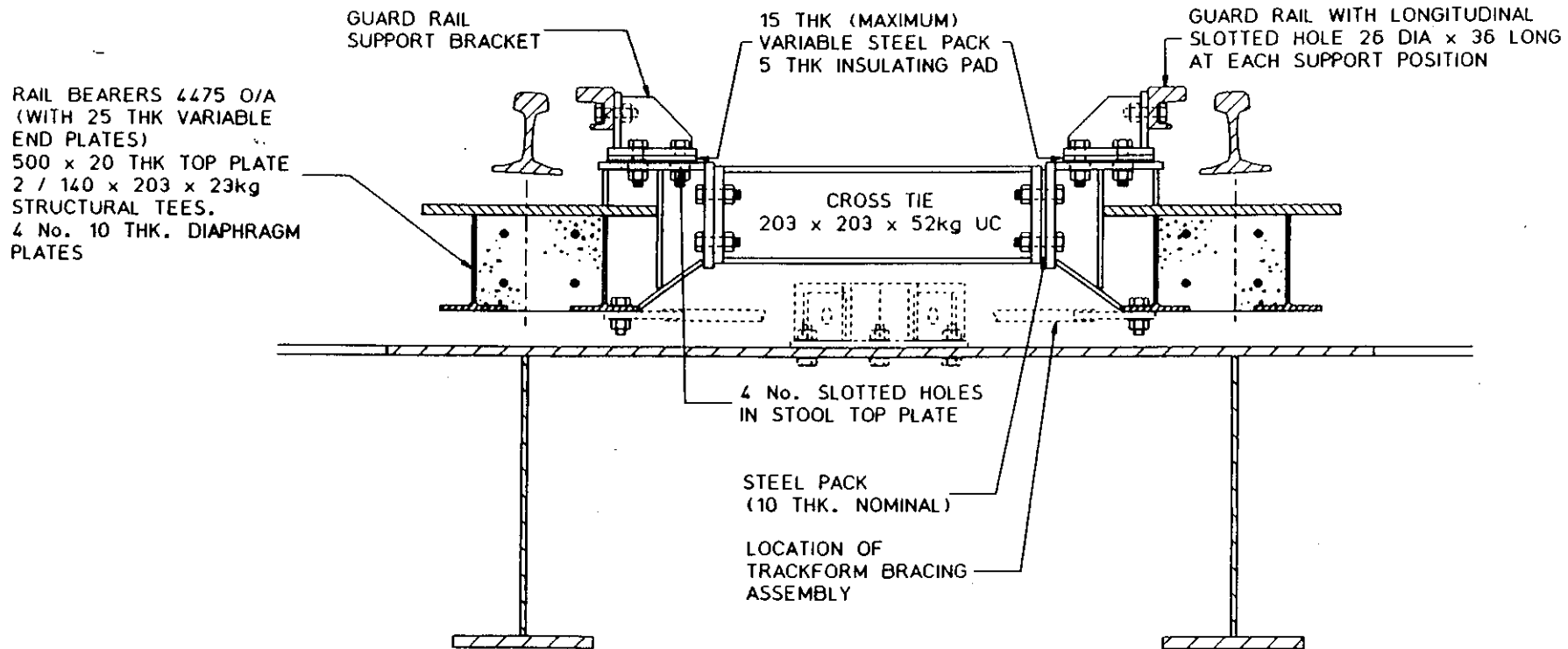

FIGURE 5.7
SECTION ON GAUGE TIE

RAIL BEARERS 4475 O/A
 (WITH 25 THK VARIABLE
 END PLATES)
 500 x 20 THK TOP PLATE
 2 / 140 x 203 x 23kg
 STRUCTURAL TEES.
 4 No. 10 THK. DIAPHRAGM
 PLATES

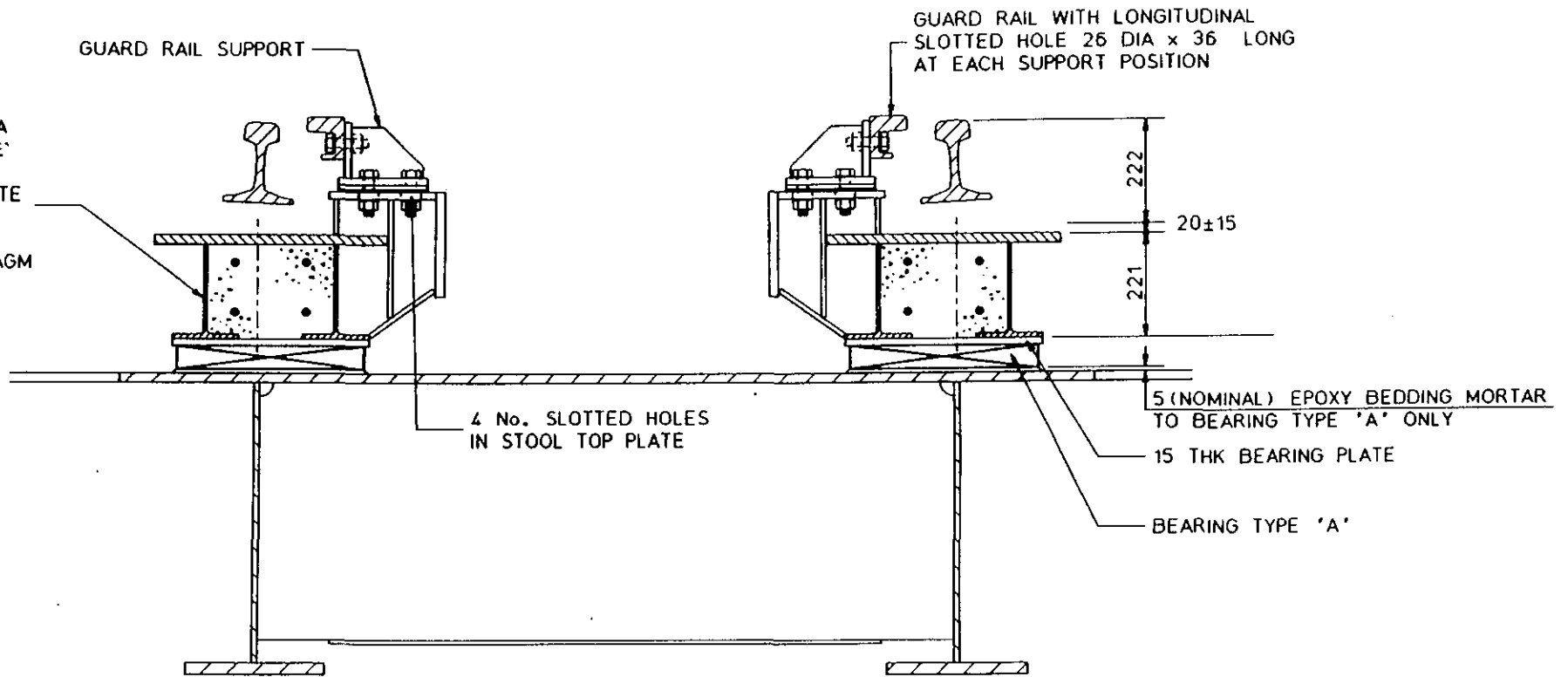

FIGURE 5.8
CROSS SECTION ON WAYBEAM DIAPHRAGM

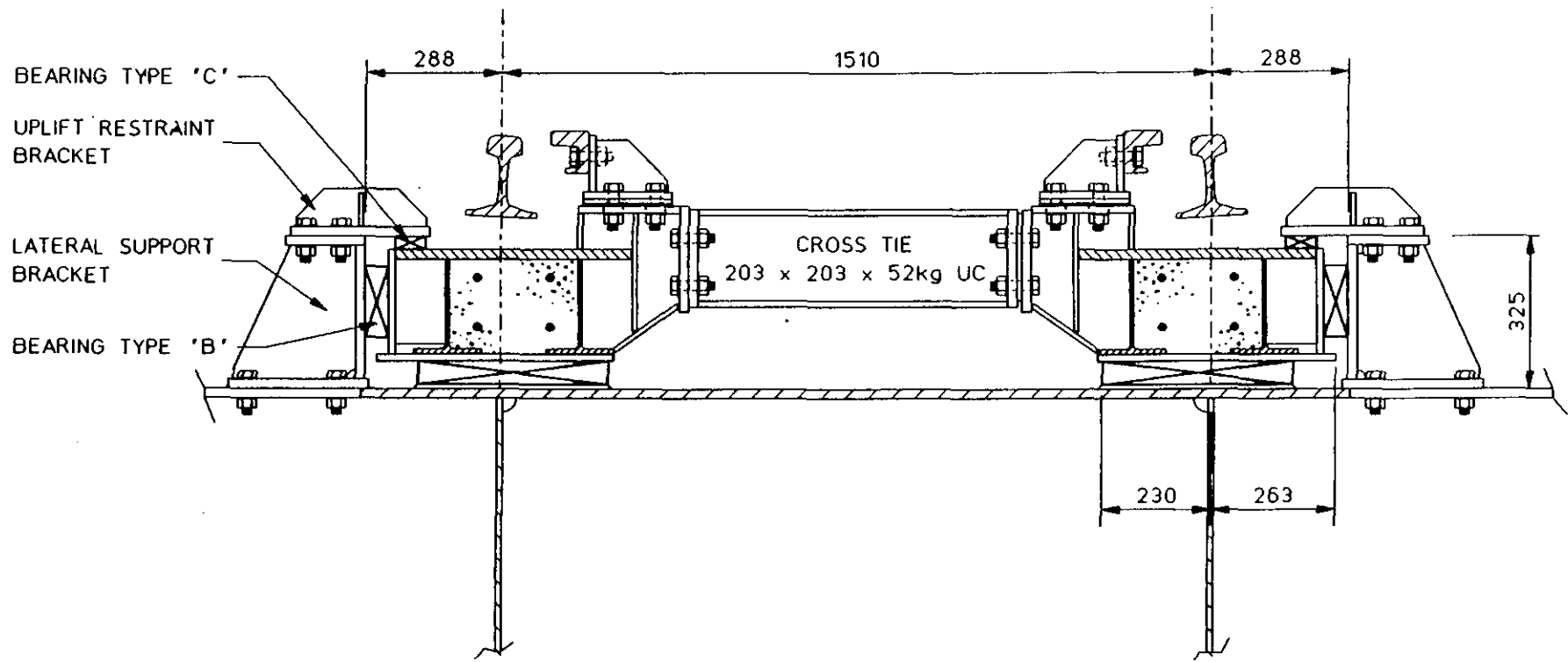

FIGURE 5.9
SECTION THROUGH MAIN/INTERMEDIATE FRAME SHOWING ARRANGEMENT
FOR LATERAL RESTRAINT OF RAIL BEARERS

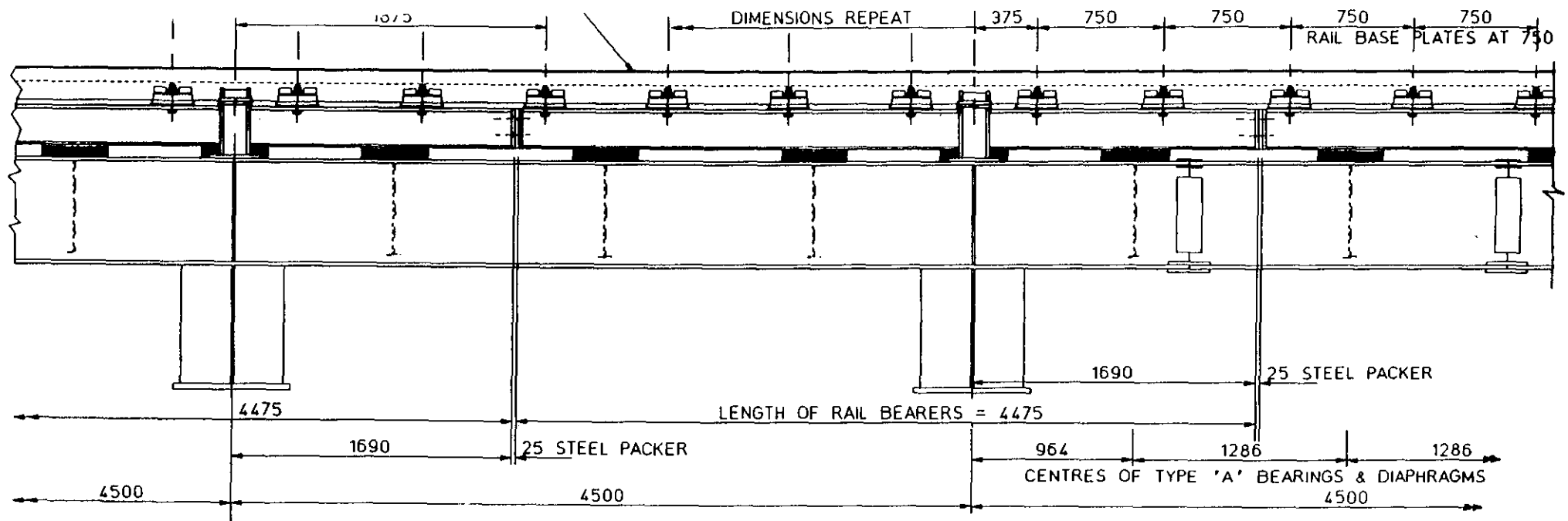

FIGURE 5.10
ELEVATION ON RAIL WAYBEAMS
SHOWING DETAILS OF RAIL BEARERS AND SUPPORTS

6. Land Use

6. LAND USE

6.1 Afteruse of Project Works Sites

Several works areas will be required for the construction of the Lantau Fixed Crossing. These works areas will have a coastal frontage in order to cater for barge loading and unloading. The works areas currently being planned include the following:

a) **Northwest Tsing Yi**

This is an area of formed land beneath the Tsing Yi tower structure of the bridge, and directly below the toll plaza area on Tsing Yi.

b) **Ma Wan Island**

The works area includes a major area on south east Ma Wan, a strip of land across the island adjacent to the Ma Wan Viaduct, and a smaller works area on the west coast.

c) **Lantau Island**

Directly north of the Kap Shui Mun Bridge tower, the small valley and bay at San Po Tsui will be developed as a works site. Also the small bay at Tsing Chau Wan will be reclaimed for use as a works area. A site in Penny's Bay may be used as a works site.

6.2 Potential Afteruses

Consultation has taken place with District Planning Office, Tsuen Wan and Lantau & Islands to discuss potential and planned after uses for the works areas once the bridges are complete. The Regional Services Department has stated that at this time they have no plans or intentions for these sites. The main points arising from these consultations are as discussed below:-

Tsing Yi Island

The Tsing Yi O.D.P., plan no D/TY/1^B currently shows an access road along the west coast, through the works area to the future shipyards on the northern coast. This road is meant to become the only access to north Tsing Yi Industrial areas, relieving residents on the northeast corner of Tsing Yi from traffic noise and pollution generated by industrial traffic.

For the remaining work site area, a proposal has been put forward for a small exhibition centre below the bridge structure. This concept is still under review.

In general, the works area can accommodate small carpark areas, passive open space and landscape reinstatement.

Ma Wan Island

There is no proposal as yet to provide a vehicular access to Ma Wan which limits the potential afteruse of the area. The works area on the southeast corner of the island has been earmarked for a possible site for the relocation of Ma Wan Village which may become necessary if and when the second bridge to Lantau begins construction. No decision on this issue is anticipated prior to 2006.

The anticipated road noise will preclude uses such as residential development close to the road and this would include all the works sites. However, recreation facilities have been discussed for the areas as a future permanent or temporary use.

Until a decision is forthcoming in the future it is recommended that landscape reinstatement be carried out such that, should no use be found for the areas, the planting would completely cover the site over time.

North Lantau

The works areas at San Po Tsui and at Tsing Chau Wan area as yet difficult to associate with an afteruse due to uncertainties with the Port Peninsula Development. Aside from general landscape reinstatement required for both sites, it is possible that the San Po Tsui area can be a passive recreation area, being directly across the water from Ma Wan Village.

Recreation uses for Tsing Chau Wan are more heavily restricted due to the likelihood of the area being incorporated into berthing and dock development in the long term future. Vegetation re-establishment is recommended for these sites.

No comment can be made regarding the after-use of the Penny's Bay works site, should this be formed for the LFC. The use of this area will be considered in the Port Peninsula Study.