

# Code of Practice for Means of Access for **Firefighting** and **Rescue**

Fireman's  
Lift



**CODE OF PRACTICE**  
**FOR**  
**THE PROVISION OF MEANS OF ACCESS**  
**FOR**  
**FIREFIGHTING AND RESCUE PURPOSES**  
  
**2004**

**BUILDING AUTHORITY**  
**HONG KONG**

**First issue : October 1989**

**This revision : December 2004**

## **FOREWORD**

Fire safety in a building is determined by a number of factors one of which is the means of access to it to enable firefighting personnel to effect rescue and fight fire. Requirements for means of access to buildings are laid down in regulations 41A, 41B, 41C and 41D of the Building (Planning) Regulations (B(P)R).

B(P)R 41D deals with the means of access for emergency vehicles to a building. It requires every building to be provided with an emergency vehicular access which is so designed and constructed as to allow safe and unobstructed access of a vehicle of the Fire Services Department to the building and to provide for the safe operation of such a vehicle, in the event of a fire or other emergency. B(P)R 41D(2) provides that the design and construction of an emergency vehicular access shall be in accordance with such requirements as may be specified by the Building Authority from time to time having regard to the intended use of the building. Part VI of this Code of Practice specifies such requirements.

B(P)R 41A, 41B and 41C deal with the means of access to inside of the building. They provide that every building shall be provided with an adequate number of access staircases, fireman's lifts and/or firefighting and rescue stairways having regard to the intended use of the building, its height and size. These staircases, lifts or stairways shall be so designed and constructed or installed as to allow firemen safe and unobstructed access to various floors of the building in the event of a fire. Part II to V of this Code of Practice provide guidance on compliance with these requirements.

This Code is issued by the Building Authority and will be reviewed regularly. The Building Authority welcomes suggestions for improving the Code.

## CONTENTS

Paragraph	Page
<b>Part I – GENERAL PROVISIONS</b>	
1. Use of the Code	1
2. Objectives	1
3. Alternative Approach to Fire Safety	1
4. Interpretations	3
<b>Part II – PROVISIONS OF ACCESS STAIRCASE, FIREMAN’S LIFTS AND FIREFIGHTING AND RESCUE STAIRWAYS</b>	
5. Number of Access Staircases, Fireman’s Lifts and Firefighting and Rescue Stairways Required	5
<b>Part III – ACCESS STAIRCASE</b>	
6. Escape Staircase as Access Staircase	5
7. Firefighting and Rescue Stairway as Escape Staircase	5
<b>Part IV – FIREMAN’S LIFT</b>	
8. Designation of Fireman’s Lift	6
9. Access to a Fireman’s Lift at Ground Level	6

10. Floors Served by a Fireman’s Lift	7
11. Liftwell of a Fireman’s Lift	8
12. Lift Car of a Fireman’s Lift	8
13. Lobby to a Fireman’s Lift	8
14. Doors of a Fireman’s Lift	9
15. Control and Operation of a Fireman’s Lift	9

**Part V – FIREFIGHTING AND RESCUE STAIRWAY**

16. Access to a Firefighting and Rescue Stairway at Ground Level	10
17. Floors Served by a Firefighting and Rescue Stairway	11
18. Access to a Floor from a Firefighting and Rescue Stairway	12
19. Protection of a Firefighting and Rescue Stairway	14
20. Construction of Access Staircase in a Firefighting and Rescue Stairway	15
21. Ventilation of Access Staircase in a Firefighting and Rescue Stairway	15
22. Fireman’s Lifts in a Firefighting and Rescue Stairway	16
23. Mechanical Ventilation of a Firefighting and Rescue Stairway	16

**Part VI – PROVISION OF EMERGENCY VEHICULAR ACCESS**

24. Emergency Vehicular Access to Virgin Sites	16
25. Emergency Vehicular Access to Redevelopment Sites	18

26. Emergency Vehicular Access Signs	19
27. Exemption and Modification	20
28. Enhanced Fire Safety Measures	21
<b>Annex A</b>	23
<b>Table 1</b>	25-26
<b>Diagrams 1 to 12</b>	27-39

## **Part I - GENERAL PROVISIONS**

### **1. Use of the Code**

- 1.1 Authorised persons, registered structural engineers and other persons responsible for the design of buildings may find this Code useful in establishing the requirements of the Building Authority for adequate access to buildings for the purpose of rescue and firefighting.
- 1.2 Adherence to the provisions contained in this Code may be taken to mean compliance with the Building Authority's requirements. Departure from these provisions will necessitate an alternative approach to be adopted and proved to the satisfaction of the Building Authority as to compliance with his requirements.

### **2. Objectives**

- 2.1 This Code seeks to achieve the objective of assisting in firefighting and in saving life of people in buildings by ensuring adequate access for firefighting personnel in the event of fire and other emergencies.
- 2.2 Other fire-safety objectives, for example, preventing the outbreak of fire, limiting the spread of fire, abating fire hazards, fire suppression, prevention of loss of property, providing means of escape, and ensuring fire resisting construction and structural integrity of buildings are not dealt with in this Code.

### **3. Alternative Approach to Fire Safety**

- 3.1 The Building Authority recognizes that fire safety may be approached in a number of ways the best of which is not necessarily prescriptive. This is particularly pertinent to buildings of special hazards which, because of their size, height, use, design, construction or location, may necessitate special consideration of the fire-safety objectives and the standards to be set.
- 3.2 The Building Authority assesses the acceptability of any alternative or complementary approach to fire safety in a building by reference to such criteria as the means of escape, the means of access, the fire services installations, the fire resisting construction, the size, the height, the use, the location, and the management

of the building. As an alternative to relying on the prescriptive provisions of the Buildings Ordinance, the Regulations made thereunder and codes of practices, the Building Authority accepts a fire-safety engineering approach that takes into account these criteria and at the same time, applies scientific and engineering principles to the protection of people and property from fire. This approach may be the only viable way to achieve a satisfactory standard of fire safety in some large and complex buildings.

3.3 Factors that should be taken into account include :

- the anticipated risk of a fire occurring in a building;
- the anticipated fire severity;
- the ability of a structure to resist the spread of fire and smoke; and
- the consequential danger to people in and around the building.

3.4 A wide variety of measures could be considered and adopted to a greater or lesser extent, as appropriate in the circumstances. These include :

- the adequacy of means to prevent fire;
- early fire warning by an automatic detection and warning system;
- the standard of means of escape;
- provision of smoke control;
- control of the rate of growth of a fire;
- the adequacy of the structure to resist the effects of a fire;
- the degree of fire containment;
- fire separation between buildings or parts of buildings;
- the standard of active measures for fire extinguishment or control;



- facilities to assist the fire service;
- the effectiveness of property management to minimise the growth and spread of fire;
- the availability of personnel trained in fire safety and fire routines; and
- the availability of any continuing control that could ensure continued maintenance of such systems.

3.5 It is possible to use quantitative techniques to evaluate risk and hazard. Some factors in the measures listed above can be given numerical values in some circumstances. The assumptions made when quantitative methods are used need careful assessment.

#### **4. Interpretations**

4.1 In this Code, unless otherwise stated, words and expression have the meaning attributed to them by the Buildings Ordinance, the Building (Planning) Regulations, the Code of Practice for Fire Resisting Construction and the Code of Practice for Means of Escape.

4.2 For ease of reference, the relevant definitions are reproduced below :

“access staircase” means a staircase so designed and constructed as to allow firemen safe and unobstructed access to all floors of a building in the event of a fire;

“basement” means any storey of a building below the ground storey and from which any exit route required by or under the Building (Planning) Regulations is in an upward direction;

“cubical extent” means the space contained within the external surfaces of the walls and roof of a building and the upper surface of the floor of its lowest storey, excluding any space within any enclosure on the roof used exclusively for accommodating a water tank or lift gear or any other services, and, if any side of the building is not enclosed by a wall, that side shall be deemed to be enclosed by a wall extending downwards from the outer edge of the roof;

“element of construction” means :

- (a) any floor, beam, column or hanger;
- (b) any load-bearing wall or load-bearing member other than a member forming the roof or part of the roof;

“emergency vehicular access”, in relation to a building, means a vehicular access used or to be used for access of a vehicle of the Fire Services Department to the building in the event of a fire or other emergency;

“firefighting and rescue stairway” means a stairway accommodating an access staircase and a fireman’s lift;

“fireman’s lift” means a lift designed and installed to be used by firemen in the event of a fire;

“FRP” means the period for which any element of construction, wall, fixed light, door, fire shutter or other building components is capable of resisting the action of fire when tested in accordance with BS 476 : Parts 20 to 24 : 1987 or as specified in the schedule to the Code of Practice for Fire Resisting Construction;

“ground storey” means the storey in which is situated an entrance from a street to a building and, where a building fronts or abuts on more than one street and due to difference in street levels there are 2 or more entrances serving different streets and situated in different storeys, means each such storey;

“refuge floor” means a protected floor that serves as a refuge for the occupants of the building to assemble in case of a fire;

“required staircase” means an access staircase, whether in a firefighting and rescue stairway or not, or a staircase required for means of escape in case of a fire.

## **Part II - PROVISION OF ACCESS STAIRCASE, FIREMAN'S LIFT AND FIREFIGHTING AND RESCUE STAIRWAY**

### **5. Number of Access Staircases, Fireman's Lifts and Firefighting and Rescue Stairways**

- 5.1 Such numbers of access staircases, fireman's lifts and firefighting and rescue stairways should be provided in a building as required by Building (Planning) Regulations 41A, 41B and 41C. The number of these means of access for firefighting and rescue as required are summarised in Table 1.
- 5.2 In any building which the Building Authority considers to be likely to bear a special hazard, i.e. high fire and life risk, such as buildings used or intended to be used wholly for entertainment, exhibition and the like, additional number of fireman's lifts and/or firefighting and rescue stairways may be required.

## **Part III - ACCESS STAIRCASE**

### **6. Escape Staircase as Access Staircase**

The escape staircases in every building provided in accordance with Building (Planning) Regulation 41(1) and the Code of Practice for Means of Escape can be taken as access staircases for the purposes of Building (Planning) Regulation 41A but can only be taken as access staircases in firefighting and rescue stairways if the requirements of Building (Planning) Regulation 41C and this Code are also complied with.

### **7. Firefighting and Rescue Stairway as Escape Staircase**

Every access staircase in a firefighting and rescue stairway provided in accordance with Building (Planning) Regulation 41C and this Code may be taken as a staircase for means of escape for the purposes of Building (Planning) Regulation 41(1) if the requirements for escape staircases specified in the Code of Practice for Means of Escape are also complied with.

## **Part IV – FIREMAN’S LIFT**

### **8. Designation of Fireman’s Lift**

- 8.1 Where more than one lift is installed in a building required to have a fireman’s lift, the lift which is to be the fireman’s lift should be that designated by the Director of Fire Services.
- 8.2 A lift mainly intended for the transport of goods in a building, in which an industrial undertaking is being, or is intended to be carried on or which is used, or is intended to be used for bulk storage or as a warehouse should not be designated as a fireman’s lift.

### **9. Access to a Fireman’s Lift at Ground Level**

- 9.1 Access to a fireman’s lift (“fire service access point”) should be available at ground level in the perimeter of the building either directly from a street which is accessible by fire service appliances or through an open area having a minimum dimension of 1.5m and having access free from any permanent obstruction to such a street. Such access should not be closed with doors or gates unless they are capable of being readily opened from the inside without the use of a key.
- 9.2 A fireman’s lift may be set back from the fire service access point at ground level in the perimeter of the building provided that the horizontal distance from the fire service access point to the doors of the fireman’s lift is not more than 18m. In cases where the physical characteristics and constraints of a site render it desirable, the Building Authority may allow a longer horizontal distance provided that fire safety standards are not adversely affected.
- 9.3 The passage from the fire service access point to the fireman’s lift should:
- (a) have a clear width of not less than 1500 mm and a clear height of not less than 2000 mm;
  - (b) be separated from the remainder of the ground storey by walls having an FRP not less than that required for the elements of construction in the ground storey. Any opening in these walls for communication with the ground storey should be through a protected lobby with walls having an FRP of not

less than that of the wall of the passage and doors having an FRP of not less than half that of the wall and complying with the same requirements for fire resisting doors specified in the Code of Practice for Fire Resisting Construction.

- 9.4 A notice in the following form indicating the fire service access point should be displayed at a conspicuous position outside the building near the point:

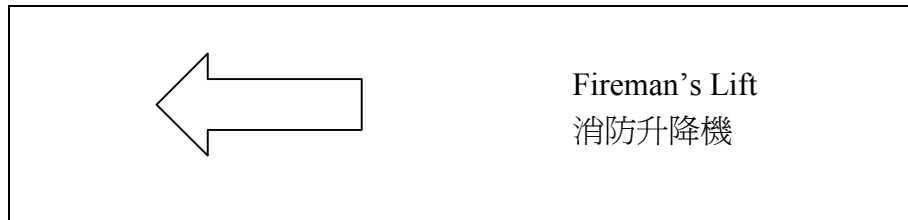

The height of the letters on the notice should be not less than 20 mm. Such notice should be either illuminated by two separate systems of electric light or a type of safety sign which is self-energized in respect of luminosity and which requires no external source of power.

## **10. Floors Served by a Fireman's Lift**

- 10.1 Fireman's lifts should be provided to enable firemen to reach any floor that may be on fire in the building without having to traverse more than two floors and should be arranged in such a way that:
- (a) in the case of a single fireman's lift, it serves at least the alternate floors;
  - (b) in the case of multiple fireman's lifts within a common lift shaft, the lifts may serve different zones of the building provided that the zones to be served are clearly indicated;
  - (c) in all cases, subject to para. 10.1(d), the pattern of service should be uniform and regular, i.e. a lift serves either the odd floors, even floors or all floors; and
  - (d) where refuge floors are provided, every such refuge floor should be served by at least one fireman's lift. The lift doors opening onto the refuge floors should be locked during normal operation but the locking device should be automatically released on actuation of the fireman's switch.

- 10.2 Where the pattern of service adopted for a fireman's lift is such that the top floor is to be served, the top floor should be served unless the lift machine room has to be located at the top floor due to statutory height restrictions.
- 10.3 The lowest landing of a fireman's lift serving the storeys above ground level or the topmost landing of a fireman's lift serving the basement, as the case may be, should be situated at the level of the fire service access point referred to in paragraph 9. If this is not possible due to site constraints or other special reasons acceptable to the Building Authority, such landing may be situated not more than one floor above or below the level of the fire service access point.
- 10.4 No part of the floor served by a fireman's lift should be more than 60 m from the door of the lift lobby measured along actual passages. If the internal layout is not known at the design stage or is not shown on plan, a direct line measurement of 40 m may be used for design purposes, provided that the layout of the floor when occupied satisfies the 60 m requirement.

## **11. Liftwell of a Fireman's Lift**

- 11.1 Separate liftwell should be provided for each fireman's lift and up to three fireman's lifts may share the same liftwell.
- 11.2 A notice should be displayed outside the liftwell indicating the fireman's lift by the words 'FIREMAN'S LIFT' and “(消防升降機)” in English and Chinese and the floors served. The height of the letters and characters on the notice should be not less than 15 mm.

## **12. Lift Car of a Fireman's Lift**

The car of a fireman's lift should have a minimum internal dimension of 1.1 m, a net internal floor area of not less than 1.35 m<sup>2</sup> and a rated load of not less than 680 kg.

## **13. Lobby to a Fireman's Lift**

- 13.1 Each point of discharge from a fireman's lift to the floor served, except at the fire service access point referred to in paragraph 9, should be through a lobby having a floor area of not less than 2.25 m<sup>2</sup> and a minimum dimension of 1.5 m. The lobby

should be separated from the floor served by walls having an FRP of not less than that required for the elements of construction in that floor, subject to a maximum of 2 hours, and doors having an FRP of not less than half that of the wall and complying with the same requirements for fire resisting doors specified in the Code of Practice for Fire Resisting Construction.

- 13.2 Openings for lighting and/or ventilation may be made in an external wall enclosing the lobby provided that the same requirements as specified in the Code of Practice for Fire Resisting Construction for openings in the external wall of a lobby to a required staircase are complied with.
- 13.3 Where only one or some of the lifts in a bank of lifts are fireman's lifts, they may share a common lift lobby, provided that such lobby is provided on every floor served by any of these lifts.
- 13.4 Every lobby to a fireman's lift should have access, without any obstruction and lockable door, to an exit route.

#### **14. Doors of a Fireman's Lift**

The door opening of a fireman's lift should not be less than 800 mm wide and 2000 mm high. The doors should be fitted with power operated automatic self-closing device.

#### **15. Control and Operation of a Fireman's Lift**

A fireman's lift should be designed and installed in accordance with the special control, operational, electrical and mechanical requirements for fireman's lifts specified in the Code of Practice on the Design and Construction of Lifts and Escalators published by the Director of Electrical and Mechanical Services.

**Part V – FIREFIGHTING AND RESCUE STAIRWAY****16. Access to a Firefighting and Rescue Stairway at Ground Level**

- 16.1 Access to a firefighting and rescue stairway (“fire service access point”) should be available at ground level in the perimeter of the building either directly from a street which is accessible by fire service appliances or through an open area having a minimum dimension of 1.5 m and having access free from any permanent obstruction to such a street. Such access should not be closed with doors or gates unless they are capable of being readily opened without the use of a key.
- 16.2 A firefighting and rescue stairway may be set back from the fire service access point at ground level in the perimeter of the building provided that the horizontal distance between the fire service access point and the doors of the fireman’s lift or the first step of the access staircase in the stairway is not more than 18 m. In cases where the physical characteristics and constraints of the site render it desirable, the Building Authority may allow a longer horizontal distance provided that fire safety standards are not adversely affected. In any case, both the fireman’s lift and the access staircase in the stairway should be accessible from the same street.
- 16.3 A firefighting and rescue stairway and the passage from the fire service access point to the stairway should be separated from the remainder of the ground storey (including a lobby or hall to cargo lifts) by walls having an FRP of not less than that required for the perimeter enclosing walls of the stairway. Any opening in these walls for communication with the ground storey should be through a protected lobby with walls having an FRP of not less than that required for the perimeter enclosing walls of the stairway and doors having an FRP of not less than half that of the wall and complying with the same requirements for fire resisting doors specified in the Code of Practice for Fire Resisting Construction.
- 16.4 The passage from the fire service access point to the firefighting and rescue stairway should have a clear width of not less than 1500 mm and a clear height of not less than 2000 mm.
- 16.5 A notice in the following form indicating the fire service access point should be displayed at a conspicuous position outside the building near the point.





The height of the letters on the notice should be not less than 20 mm. Such notice should be either illuminated by two separate systems of electric light or a type of safety sign which is self-energized in respect of luminosity and which requires no external source of power.

## **17. Floors Served by a Firefighting and Rescue Stairway**

- 17.1 Both the access staircase and the fireman's lift in firefighting and rescue stairway should serve every floor, including a refuge floor, and every part of the building. When the roof of the building is served by other staircases, the access staircase in the firefighting and rescue stairway should also serve the roof. For the avoidance of doubt, the fireman's lift is not required to serve the roof but it should serve the top floor unless the lift machine room has to be located at the top floor due to height restriction.
- 17.2 Where a building is required to have a firefighting and rescue stairway, areas for ancillary uses such as car parking and loading and unloading in the building, whether occupying the whole floor or part of a floor, shall also be served by the firefighting and rescue stairway.
- 17.3 The lowest landing of the fireman's lift in a firefighting and rescue stairway serving the storeys above ground level or the topmost landing of that serving the basement, as the case may be, should be situated at the level of the fire service access point referred to in paragraph 16. If this is not possible due to site constraint or other special reasons acceptable to the Building Authority, such landing may be situated not more than one floor above or below the level of the fire service access point.
- 17.4 Every access staircase in a firefighting and rescue stairway serving the upper floors should not continue directly to serve the basement floors.
- 17.5 Every access staircase in a firefighting and rescue stairway passing through a refuge floor should discontinue at such level so that the access route is diverted to pass over

the area for refuge before it is continued to access upwards. The doors of the fireman's lift opening onto the refuge floor should be locked during normal operation but the locking device should automatically release on actuation of the fireman's switch.

- 17.6 No part of the floor served by a firefighting and rescue stairway should be more than 60 m from the door of the lobby to the stairway measured along actual passages. If the internal layout is not known at the design stage or is not shown on plan, a direct line measurement of 40 m may be used for design purposes, provided that the layout of the floor when occupied satisfies the 60 m requirement.

## **18. Access to a Floor from a Firefighting and Rescue Stairway**

- 18.1 In every floor, except the ground storey, served by a firefighting and rescue stairway, access from the stairway to that floor should be through a lobby which should –
- (a) have a floor area of not less than 5 m<sup>2</sup> and not more than 10 m<sup>2</sup> with a minimum dimension of 1.5 m;
  - (b) in storeys above ground level, have an external wall as one of its enclosing walls;
  - (c) in storeys above ground level, be provided with natural ventilation by means of openings on the external wall provided in accordance with paragraph 18.1(b). Such openings –
    - (i) should have a total area of not less than 25 per cent of the floor area of the lobby;
    - (ii) should be situated as near the ceiling as is practicable and in no case should the top of such openings be less than 1.9 m above the level of the lobby floor;
    - (iii) should face directly into the external air which has a horizontal area of not less than 21 m<sup>2</sup> and is vertically uncovered and unobstructed above. If it is enclosed on all sides, it should have an area of not less than 1 m<sup>2</sup> per 1 m height of the enclosing walls and have a minimum dimension of 1.5m.

- (iv) may be provided with windows which should be side hung, open outward a minimum of 30°, be openable from inside without the use of a key and be fitted with simple lever handles or rotary drives to simple rack or gear operated devices; and
- (d) in storeys below ground level, be provided with natural ventilation by -
- (i) unobstructed smoke outlets having a cross-sectional area of not less than 1 m<sup>2</sup> for each lobby and ventilating into the outside air above ground level. Lobbies at basement levels should be individually ventilated by separate smoke outlets provided at the ceiling of the lobby. Such smoke outlets may be covered at or above ground level with breakable covers and should be located at least 5 m clear of the final point of discharge of an exit route or a fire service access point. This distance may be reduced to not less than 2.5 m if, and only if, any smoke from such smoke outlets is directed away from and is not likely to affect, by natural convection, any exit route or fire service access point. The smoke outlet shafts should have an FRP or be enclosed by construction having an FRP not less than that of the perimeter walls of the firefighting and rescue stairway. An unenclosed smoke outlet shaft should be capable of resisting accidental mechanical damage and should satisfy the hard body impact test in accordance with BS 5669; or
  - (ii) openings complying with paragraph 18.1(c)(i), (ii) and (iv) and ventilating into an open well having an area of not less than 1 m<sup>2</sup> per 1 m height of the wall enclosing the open well and having a minimum dimension of 1.5 m;

provided that natural ventilation to the lobby is not required if the access staircase to which the lobby leads is a staircase which is open on 3 sides for a height of not less than 900 mm between the top of the balustrade or parapet and the underside of the flight of stair immediately above, and which is open to a void having an area of not less than 10 m<sup>2</sup> and a minimum dimension of 1 m and being unobstructed above to provide adequate ventilation.

18.2 Every fireman's lift in a firefighting and rescue stairway should open into the lobby provided in accordance with paragraph 18.1.

18.3 The access staircase and the fireman's lift in a firefighting and rescue stairway should communicate with each other at every floor served by the stairway.

## **19. Protection of a Firefighting and Rescue Stairway**

19.1 Every firefighting and rescue stairway should be enclosed by walls and these walls, the landings, flights, balustrades and partition walls in the stairway should be constructed wholly of non-combustible materials. No finishing, including wall and ceiling lining and floor finishing, in the stairway should be combustible.

19.2 The perimeter enclosing walls that separate the access staircase, the fireman's lift and the lobby in a firefighting and rescue stairway from the floor served by the stairway, together with any supporting structure and floor slabs forming the enclosures of the stairway, should have an FRP twice that required for the elements of construction in that floor, subject to a maximum of 4 hours.

19.3 Within the perimeter walls of a firefighting and rescue stairway, walls or partitions which separate the access staircase and the lobby from each other should have an FRP of not less than 1 hour.

19.4 The doors of the lobby to a firefighting and rescue stairway should -

- (a) have an FRP of not less than 1 hour;
- (b) comply with the same requirements for fire resisting doors specified in the Code of Practice for Fire Resisting Construction; and
- (c) not be fitted with any bolts, locks or other fastenings except that, if for security reasons, the door between the lobby and the floor served may be fitted with a lock which is openable from the floor side without the use of a key.

19.5 Openings formed in the external walls of a firefighting and rescue stairway for the purposes of this Code should also comply with the relevant provisions in the Code of Practice for Fire Resisting Construction and in no case should such openings be

formed within 450 mm measured horizontally from any opening in the external walls of the same building.

## **20. Construction of Access Staircase in a Firefighting and Rescue Stairway**

Every access staircase in a firefighting and rescue stairway should -

- (a) have a clear width of not less than 1050 mm and a clear height of not less than 2000 mm;
- (b) be arranged in straight flights without winders and each flight should consist of not more than 16 risers nor less than 2 risers. Treads should be not less than 225 mm wide, measured clear of nosings, and risers should be not more than 175 mm high;
- (c) be provided with landings at the top and bottom of each flight with a minimum dimension of not less than the width of the flight and no door should at any part of its swing reduce the effective width or effective radius of such landings; and
- (d) be provided with handrails on each side of the staircase at a height of not less than 850 mm and not more than 1100 mm above the steps or landings. The handrails should not project so as to reduce the clear width of the staircase by more than 90 mm for each handrail and should be continuous throughout each flight of the staircase but need not be carried round a landing or half landing.

## **21. Ventilation of Access Staircase in a Firefighting and Rescue Stairway**

Every access staircase in a firefighting and rescue stairway should be provided with natural ventilation -

- (a) at each storey above the ground storey, by openings in the external enclosure wall having a total area of not less than 15 per cent of the internal area on plan of the access staircase. Such openings may be provided with windows which should be side hung, open outward a minimum of 30°, be openable from inside without the use of a key and be fitted with simple lever handles or rotary drives to simple rack or gear operated devices; and

- (b) at its highest point, by a vent capable of being opened manually or automatically by a remote control switch and having an area of not less than 5 per cent of the internal area on plan of the access staircase. The remote control switch should be situated in a conspicuous position at the fire service access point of the stairway at ground level.

## **22. Fireman's Lifts in a Firefighting and Rescue Stairway**

- 22.1 Up to three fireman's lifts, but no other lifts, may be installed and may share the same liftwell in a firefighting and rescue stairway. A lift mainly intended for the transport of goods should not be designated as a fireman's lift.
- 22.2 Every fireman's lift in a firefighting and rescue stairway should comply with the requirements specified in paragraphs 11.2, 12, 14 and 15 of this Code.

## **23. Mechanical Ventilation of a Firefighting and Rescue Stairway**

Any natural ventilation to a firefighting and rescue stairway and its lobby required in this Code may be omitted where a mechanical system to control the ingress of smoke into the stairway or lobby, such as pressurisation, is provided to the satisfaction of the Director of Fire Services.

## **Part VI - PROVISION OF EMERGENCY VEHICULAR ACCESS**

### **24. Emergency Vehicular Access to Virgin Sites**

- 24.1 For the purpose of Building (Planning) Regulation 41D, this paragraph specifies the design and construction requirements of emergency vehicular access (EVA) serving buildings erected or to be erected on virgin sites. A "virgin site" means a site where there is no temporary or permanent building, including a building exempted from the Buildings Ordinance under the Buildings Ordinance (Application to the New Territories) Ordinance, in existence before. For the avoidance of doubt, the requirements in this paragraph should also apply to all subsequent redevelopments on virgin sites.
- 24.2 Every EVA to which this paragraph applies should be designed and constructed in accordance with the following requirements, unless otherwise specified in this

paragraph :

- (a) The width of an EVA in the form of a carriageway should be not less than 7.3m. An EVA that is not in the form of a carriageway should be hard-paved, not less than 6 m wide and well demarcated on site.
- (b) If there is any overhead structure over any part of the EVA, a clear headroom of not less than 4.5 m should be maintained.
- (c) The gradient of the EVA should not be steeper than 1 in 10. For such portion of the EVA that is not serving any major facade of any building, the gradient may be increased to not steeper than 1 in 6. Wherever there is a change in gradient, the EVA should be designed and constructed in accordance with the requirements illustrated in Diagram 5 so as not to cause any obstruction to the fire appliances.
- (d) The EVA should allow safe and unobstructed access and safe operation of a fire appliance having the following specifications :

Gross weight	30,000 kg
Turning circle	26 m
Length	12 m

Turning space for fire appliances should be provided at all dead-end EVA.

- (e) The EVA should serve at least one major facade of the building. For this purpose, a major facade of a building is the facade having not less than one-fourth of the total length of all the perimeter walls of the building. In case the major facade is less than one-fourth of the total length of all the perimeter walls of the building, the EVA should serve this major facade and, in addition, other facades of the building such that the aggregate length of the facades served is not less than one-fourth of the total length of all the perimeter walls of the building. A part of the building facade is deemed to be served by the EVA if the horizontal distance between the EVA and such part of the facade does not exceed 10m. This requirement on horizontal distance from the EVA shall not apply to the level of the building facade more than 60 m high measuring from the level of the EVA serving the facade. The part of the EVA serving a building facade should not be covered.

24.3 Subject to paragraph 24.2 above, every EVA should comply with the following requirements according to the usage or occupancy of the building it serves :

- (a) For an industrial building, EVA should be provided to serve two opposite facades that are remote from each other and each having a length of not less than one-fourth of the total length of all the perimeter walls of the building. If access to the site from more than one street is available, the EVA serving the two facades should gain access from different streets. The EVA should be in the form of a two-way carriageway and the width of the carriageway should be not less than 13.5 m if there is no central divider. If there is a central divider, the width of each carriageway should not be less than 7.3 m. If any such EVA is outside the site, a reserve area of not less than 6 m wide measured from the building boundary alongside that EVA should be provided as an additional EVA (see illustration in Diagram 6).
- (b) For a cinema or theatre, the EVA should comply with the requirements of thoroughfares stipulated in paragraph 22 in Part III of the Code of Practice for the Provision of Means of Escape in Case of Fire. This paragraph is extracted at Annex A for reference.
- (c) For a building with mixed usages or occupancies, the EVA should meet the most stringent requirements for any particular type of usage or occupancy specified in this paragraph.

24.4 For an EVA which is not normally used as access for other vehicles to the building, an emergency crash gate conforming to or equivalent to the Highways Department standards as illustrated in Diagram 7 should be provided perpendicular to the centre line of the EVA. A clear space should be provided in front of the crash gate in accordance with the illustration in Diagram 8.

## **25. EVA to Redevelopment Sites**

25.1 For the purpose of Building (Planning) Regulation 41D, this paragraph specifies the design and construction requirements of EVA serving buildings erected or to be erected on redevelopment sites, i.e. not virgin sites.



- 25.2 Every EVA to which this paragraph applies should be designed and constructed in accordance with the requirements prescribed in paragraph 24.2(b), (c) and (d). An EVA that is not in the form of a carriageway should be hard-paved and well demarcated on site.
- 25.3 Subject to paragraph 25.2 above, every EVA should comply with the following requirements according to the usage or occupancy of the building it serves :
- (a) For an industrial building, the EVA should serve at least one major facade of the building in accordance with paragraph 24.2(e). Such EVA should have a minimum width of 7.3 m.
  - (b) For a cinema or theatre, the EVA should comply with the requirements of thoroughfares stipulated in paragraph 22 in Part III of the Code of Practice for the Provision of Means of Escape in Case of Fire. This paragraph is extracted at Annex A for reference.
  - (c) For a building of any other types of usage or occupancy, the EVA should serve at least one major facade of the building in accordance with paragraph 24.2(e). Such EVA should have a minimum width of 6 m.
  - (d) For a building with mixed usages or occupancies, the EVA should meet the most stringent requirements for any particular type of usage or occupancy specified in this paragraph.
- 25.4 Emergency crash gates should be provided to the EVA in accordance with paragraph 24.4.

## **26. EVA Signs**

- 26.1 For the purpose of Building (Planning) Regulation 41D, this paragraph specifies the requirements of signage for EVA to indicate the extent of the designated EVA within a site.
- 26.2 For an EVA in the form of a carriageway :
- (a) A sign showing the layout of the EVA should be erected at the entrance of the EVA (see sample at Diagram 9);

- (b) EVA indication signs should be erected at an interval of not more than 100 m along the EVA (see sample at Diagram 10); and
- (c) "No Parking" signs conforming to standards stipulated in the Road Traffic (Parking on Private Roads) Regulations and the Code of Practice for Private Roads issued by the Transport Department should be erected at an interval of not more than 50 m along the EVA except where designated carparks are marked (see sample at Diagram 11).

26.3 For an EVA which is not in the form of a carriageway :

- (a) A sign showing the layout of the EVA should be erected at the entrance of the EVA (see sample at Diagram 9); and
- (b) EVA indication signs should be provided in accordance with paragraph 26.2(b) above. Alternatively, emergency route signs should be fixed to kerbstones, planters, or other similar objects as appropriate at an interval of not more than 100 m to mark the EVA. Such signs could be painted or engraved and should be made of durable materials such as metal (see sample at Diagram 12).

## **27. Exemption and Modification**

27.1 A building may be exempted from any or all of the design and construction requirements of EVA stipulated in paragraphs 24, 25, and 26 under Building (Planning) Regulation 41D(3) in the following cases :

- (a) when the purpose for which the building is to be used constitutes a low fire risk;  
or
- (b) when the site is situated in an area the topographical features of which make the provision of an EVA or the compliance with requirements in paragraphs 24, 25 and 26 above impracticable.

27.2 When the circumstances in paragraph 27.1 arise that an EVA will not be provided or when the EVA provided cannot meet the standards as stipulated in this part of the code, an application for exemption from Building (Planning) Regulation 41D(1) or (2) should be submitted and, if required by the Building Authority, justified by a fire-safety report. The report should assess the probability of occurrence and the

likely consequence of a fire incident. Factors such as fire load, spread of fire and density of population in different parts of the building, the behavior of the occupants in case of panic and the impact of topographical constraints (in case of paragraph 27.1(b) only) to the ingress and egress to and from the building should be analyzed. The Building Authority in consultation with the Director of Fire Services will consider such an application on its individual merits.

27.3 Examples of buildings that may be considered as having low fire risk under paragraph 27.1(a) include a microwave transmitter station, a beach house, seawall or a pylon supporting cables. Factors mentioned in paragraph 27.2 above should be analyzed to determine whether a building is of low fire risk.

27.4 Examples of sites that may be considered as having topographical constraints under paragraph 27.1(b) include a site abutting a stepped street or abutting a road or street that is not up to the standards specified in this part of the code and the owner of the site has no control over such road or street. For sites locating in remote areas or in outlying islands where fire appliances of smaller size can be deployed, the access requirements will be specified by the Building Authority in consultation with the Director of Fire Services on a case-by-case basis.

## **28. Enhanced Fire Safety Measures**

28.1 Under Regulation 41D(4) of the Building (Planning) Regulations, the Building Authority may require the provision of enhanced fire safety measures to compensate for the non-provision or deficiency of EVA when exemption is granted as stipulated in paragraph 27. The enhanced fire safety measures so required may include enhanced provisions of means of escape, means of access, fire resisting construction, fire service installations or a combination of these measures.

28.2 Based on the consideration of protection of means of escape and adequacy of water supply for fire suppression, additional fire service installations in pursuance of the Code of Practice for Minimum Fire Service Installations and Equipment issued by the Director of Fire Services may be required as enhanced fire safety measures for the building in case of non-provision or deficiency of EVA. The following typical enhancements on fire safety measures may be varied according to special circumstances of each case :

(a) Sprinkler system of light hazard group under the Loss Prevention Council Rule

should be provided to protect all common areas of domestic buildings including lift lobbies, staircases, common corridors and all exit routes leading to ground level. An independent sprinkler tank of appropriate capacity should be provided. For composite (domestic and commercial) buildings, sprinkler system of appropriate hazard group should be provided to protect the entire commercial portion (irrespective of the floor area) and all common areas of the domestic portion. Sprinkler heads should be of the approved fast response type.

- (b) Pressurisation of staircase or natural venting of staircase should be provided in accordance with the standards and specifications as laid down in the Code of Practice for Minimum Fire Service Installations and Equipment.
- (c) A direct line to the Fire Services Communication Centre of the Fire Services Department should be provided and connected to the sprinkler alarm system and manual fire alarm system. Despite the provision of such direct line, the capacity of the sprinkler water tank, with both ends fed water supply, is not allowed to be reduced to 2/3.
- (d) Enhanced size of water tank/inflow rate for sprinkler or fire hydrant/hose reel system tank.
- (e) Any combination of the above items.

## **Annex A**

For the purpose of paragraphs 24.3(b) and 25.3(b) of this code, every EVA to a cinema or theatre should comply with the requirements on thoroughfares for places of public entertainment in paragraph 22 of the Code of Practice for the Provision of Means of Escape in Case of Fire. The paragraph is extracted below for reference :

### **22. Site**

- 22.1 The site of a place of public entertainment should abut upon and have frontages to 2 or more thoroughfares.
- 22.2 The frontages of a building having a place of public entertainment should, subject to paragraph 22.7, form at least one-half of the total boundaries of the site on which the building is situated, excluding recesses and projections which do not prejudicially affect exit routes, and should permit of the provision of exit routes in accordance with this Code from each tier or floor direct to 2 or more thoroughfares.
- 22.3 The thoroughfares referred to in paragraph 22.2 should be of such widths as will enable persons who are to be accommodated in the place of public entertainment to disperse rapidly in the event of fire or panic and as will afford reasonable facilities for the approach of fire appliances.
- 22.4 In the case of a place of public entertainment which is capable of accommodating more than 500 but not more than 2,000 persons one of the thoroughfares referred to in paragraph 22.2 should be at least 12 m wide.
- 22.5 In the case of a place of public entertainment which is capable of accommodating more than 2,000 but not more than 3,000 persons one of the thoroughfares referred to in paragraph 22.2 should be at least 12 m wide and the other one should be at least 9 m wide if a carriageway or 6 m wide if a footway.
- 22.6 In the case of a place of public entertainment which is capable of accommodating more than 3,000 but not more than 5,000 persons one of the thoroughfares referred to in paragraph 22.2 should be at least 15 m wide and the other should be at least 9 m wide.
- 22.7 In the case of a place of public entertainment which is capable of accommodating

more than 5,000 persons such further frontage to the thoroughfares referred to in paragraph 22.2 should be provided as the Building Authority may require.

- 22.8 In the case of a place of public entertainment which is capable of accommodating not more than 500 persons, the Building Authority should determine the number and width of thoroughfares required to be provided as access to the places of public entertainment.

**Table 1**  
**Number of Access Staircases, Fireman's Lifts and Firefighting and Rescue Stairways Required**

Type of Building		No. of Access Staircases required	No. of Fireman's Lifts Required	No. of Firefighting and Rescue Stairways Required
(1) All buildings and all basements	not exceeding 1 storey	---	---	---
(2) Domestic buildings for single household	not exceeding 3 main storeys	---	---	---
(3) Domestic buildings or offices with G/F shop or carport	(a) exceeding 1 storey but not exceeding 6 storeys and uppermost floor not exceeding 13m above ground and usable floor area not exceeding 250m <sup>2</sup> per floor	one	---	---
	(b) exceeding 1 storey but not exceeding 6 storeys and uppermost floor exceeding 13m but not exceeding 17m above ground and usable floor area not exceeding 150m <sup>2</sup> per floor	one	---	---
(4) Domestic buildings or domestic part of composite buildings, other than buildings in (2) and (3)	(a) exceeding 1 storey but not exceeding 30m above mean level of lowest street, irrespective of cubical extent	two or more (as many as escape staircases)	---	---
	(b) exceeding 2 storeys and exceeding 30m above mean level of lowest street, irrespective of cubical extent	two or more (as many as escape staircases)	one within 60m of any part of floor	---
(5) Non-domestic buildings or non-domestic part of composite buildings other than industrial undertakings, bulk storage, warehouses, places of public entertainment, hotels, hospitals or buildings in (3)	(a) exceeding 1 storey but not exceeding 15m above mean level of lowest street, irrespective of cubical extent	two or more (as many as escape staircases)	---	---
	(b) exceeding 1 storey and exceeding 15m but not exceeding 30m above mean level of lowest street and not exceeding 7000m <sup>3</sup> in cubical extent including basements	two or more (as many as escape staircases)	---	---
	(c) exceeding 2 storeys and exceeding 15m but not exceeding 30m above mean level of lowest street and exceeding 7000m <sup>3</sup> in cubical extent including basements	two or more (as many as escape staircases)	one within 60m of any part of floor	---

	(d) exceeding 2 storeys and exceeding 30m above mean level of lowest street, irrespective of cubical extent	two or more (as many as escape staircases)	one within 60m of any part of floor	---
(6) Places of public entertainment, hotels or hospitals	(a) exceeding 1 storey but not exceeding 2 storeys	two or more (as many as escape staircases)	---	---
	(b) exceeding 2 storeys, irrespective of height above mean level of lowest street and cubical extent	two or more (as many as escape staircases)	one within 60m of any part of floor	---
(7) Industrial undertakings, bulk storage or warehouses	(a) exceeding 2 storeys but not exceeding 30m above mean level of lowest street and not exceeding 7000m <sup>3</sup> in cubical extent including basements	two or more (as many as escape staircases)	one within 60m of any part of floor	---
	(b) exceeding 1 storey but not exceeding 30m above mean level of lowest street and exceeding 7000m <sup>3</sup> in cubical extent including basements	two or more (as many as escape staircases)	one within 60m of any part of floor	one within 60m of any part of floor
	(c) exceeding 1 storey and exceeding 30m above mean level of lowest street but not exceeding 7000m <sup>3</sup> in cubical extent including basements	two or more (as many as escape staircases)	one within 60m of any part of floor	one within 60m of any part of floor
	(d) exceeding 1 storey, 30m above mean level of lowest street and 7000m <sup>3</sup> in cubical extent including basements	two or more (as many as escape staircases)	one within 60m of any part of floor	one within 60m of any part of floor
(8) All basements	(a) exceeding 2 storeys and exceeding 7000m <sup>3</sup> in cubical extent	two or more (as many as escape staircases)	one within 60m of any part of floor	one within 60m of any part of floor
	(b) exceeding a depth of 9m from the floor level of the ground storey above the basement to the floor level of the lowest storey in the basement and exceeding 7000m <sup>3</sup> in cubical extent	two or more (as many as escape staircases)	one within 60m of any part of floor	one within 60m of any part of floor

### Note



An access staircase in a firefighting and rescue stairway will be counted as one access staircase for the purpose of Building (Planning) Regulation 41A and a fireman's lift in a firefighting and rescue stairway will be counted as one fireman's lift for the purpose of Building (Planning) Regulation 41B.

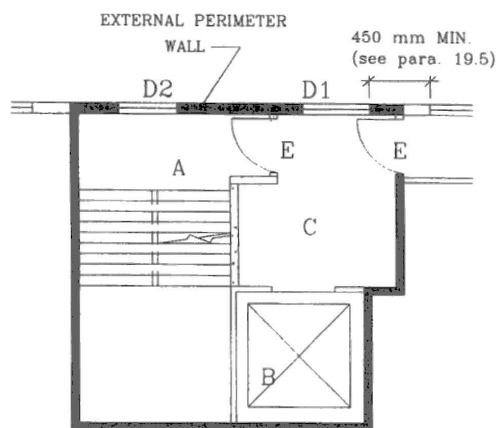

Diagram 1 Requirements of a firefighting and rescue stairway above ground level



## KEY

	Perimeter enclosure walls (FRP=2xFRP of storey, max.4 Hrs.)
	Lobby walls (minimum 1 Hr. FRP)
A	Access Staircase --min. width 1.05m (see para. 20(a))
B	Fireman's Lift --min. car size 1.35m <sup>2</sup> and rated load 680 kg (see para. 12)
C	Ventilated Lobby --size 5m <sup>2</sup> --10m <sup>2</sup> . min. dimension 1.5m (see para. 18.1(a))
D1	Lobby Openings --min. size 25% of lobby floor area (see para. 18.1(c))
D2	Staircase Windows --min. size 15% of staircase area (see para. 21(a))
E	Lobby Doors --self-closing with min. 1 Hr. FRP (see para. 19.4)

N.B. Ventilation may be omitted where a suitable mechanical system, such as pressurisation, is provided to the satisfaction of the Director of Fire Services (see para. 23)

Diagram 2 Ventilation of lobby of firefighting and rescue stairway below ground level

Alternative 1 (smoke outlets)

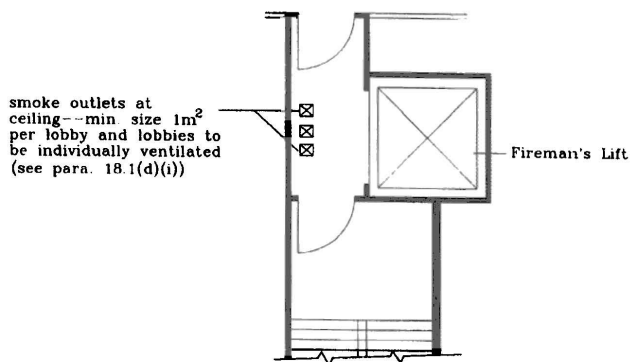

Alternative 2 (open well)

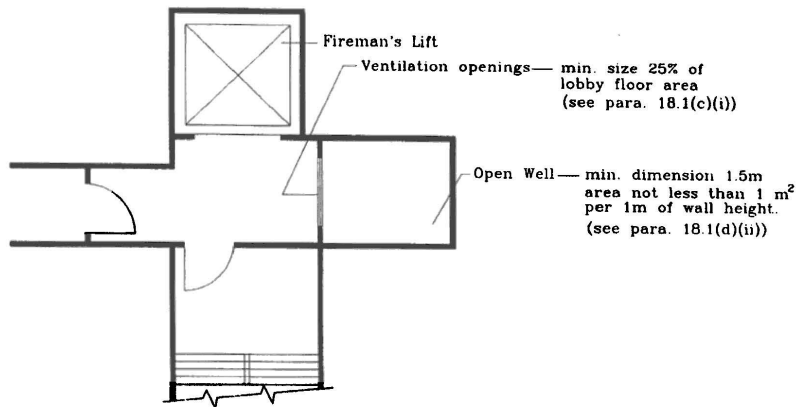

Alternative 3 (open staircase)

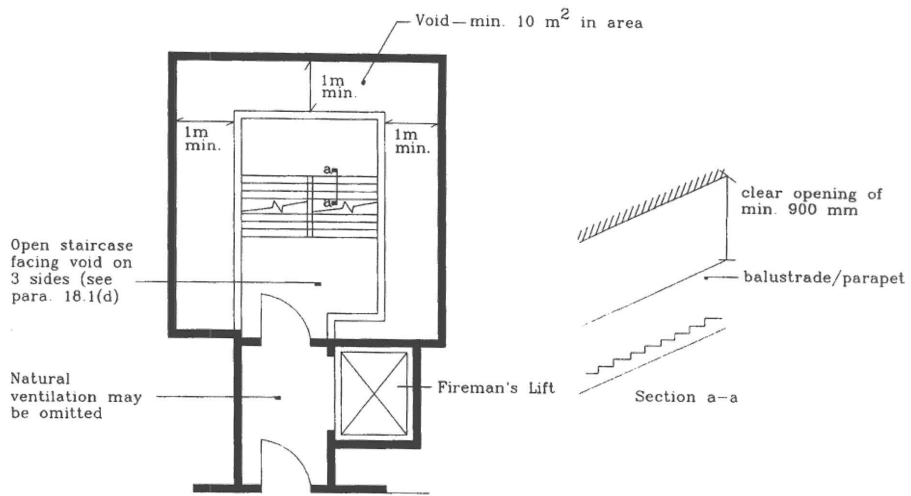

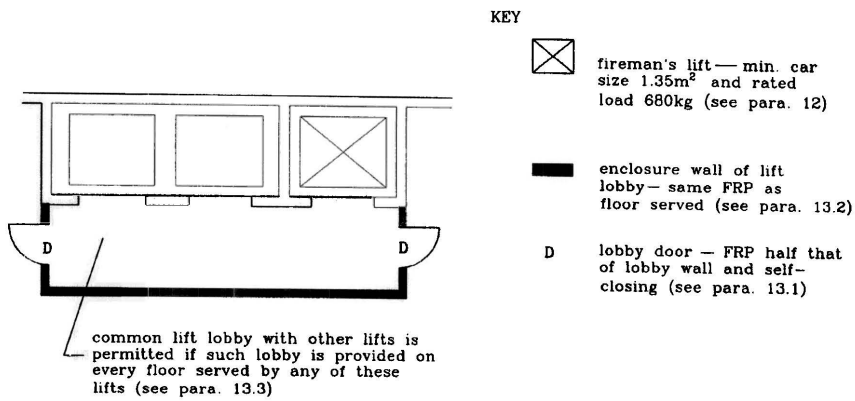
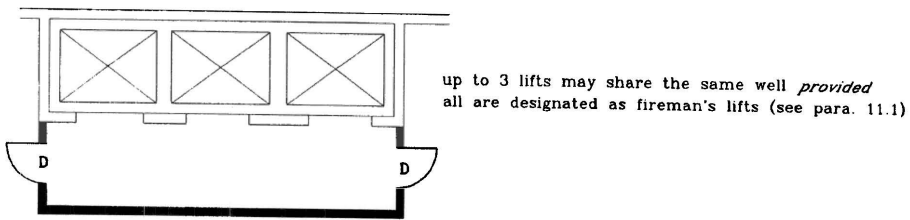
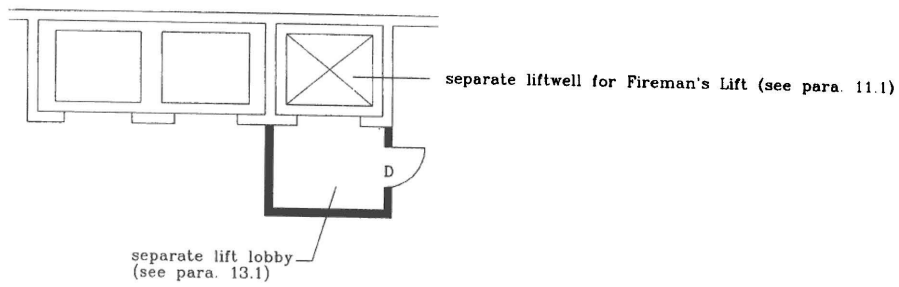

N.B. Ventilation may be omitted where a suitable mechanical system, such as pressurisation, is provided to the satisfaction of the Director of Fire Services (see para. 23)

Diagram 3 Fireman's lift



KEY

-  fireman's lift—min. car size 1.35m<sup>2</sup> and rated load 680kg (see para. 12)
-  enclosure wall of lift lobby—same FRP as floor served (see para. 13.2)
- D lobby door — FRP half that of lobby wall and self-closing (see para. 13.1)

N.B. Where more than one lift is installed, the Director of Fire Services shall designate the fireman's lift (para. 8.1)

Diagram 4 Access to a Fireman's Lift at Ground Level  
(see paragraph 9.2)

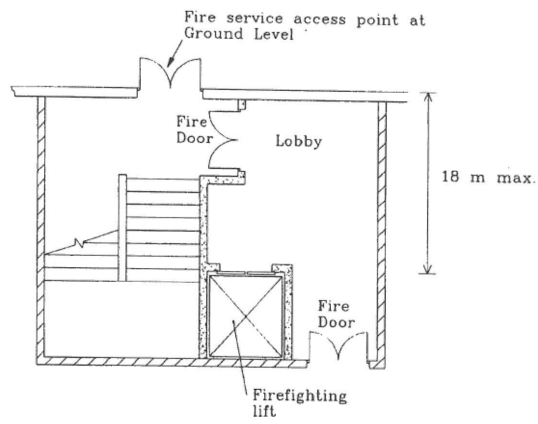

KEY



Minimum fire resistance of 2 h from outside the firefighting shaft and 1 h from inside the firefighting shaft



Minimum fire resistance of 1 h from both sides

**Diagram 5 Requirement on change in gradient of EVA (paragraph 24.2(c))**

Notes:

1. For any change in gradient of EVA, the acute angle  $\alpha$  between the two adjoining planes shall not be greater than 6 degrees.
2. In the case of a change in gradient of EVA where the acute angle between the two planes is larger than 6 degrees, there should be provided an intermediate plane of a minimum length of 10m such that the requirement in note 1 above is complied with, i.e. all the acute angles  $\alpha$  between the adjoining planes shall not be greater than 6 degrees.
3. If the intermediate plane is a bend, the plane should be of a minimum length of 12m measured along the centerline of the plane.

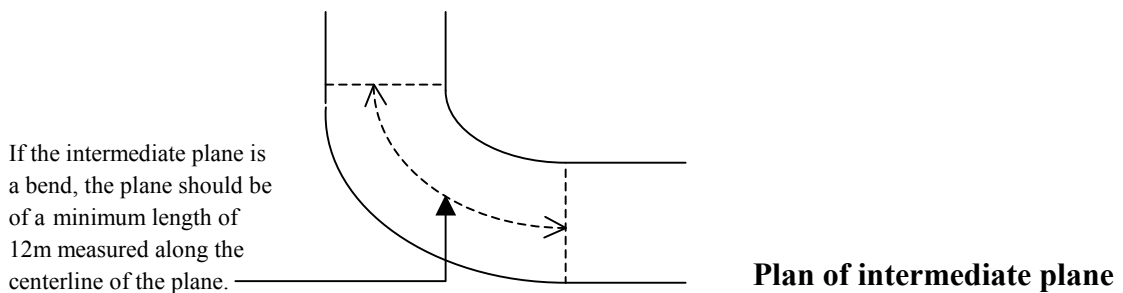
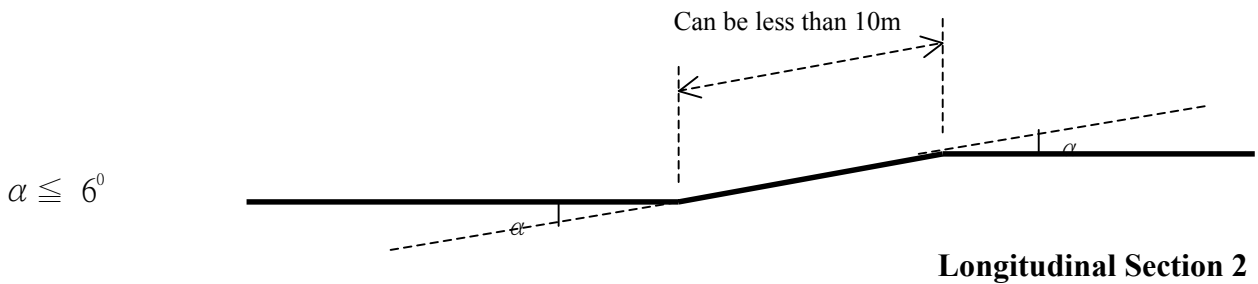
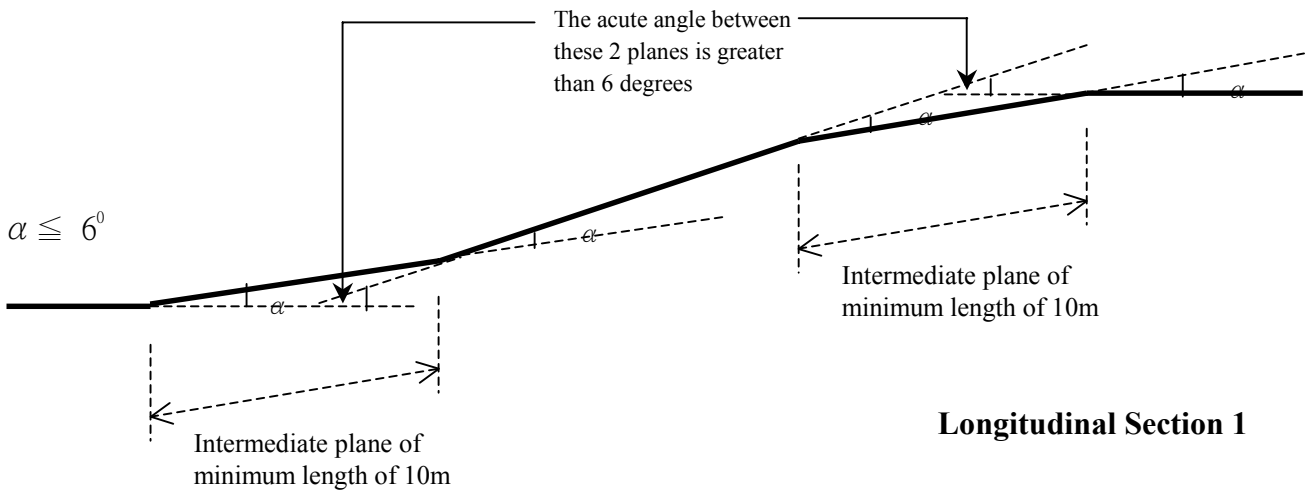

**Diagram 6 Requirements of EVA for industrial buildings in virgin sites (Paragraph 24.3(a))**

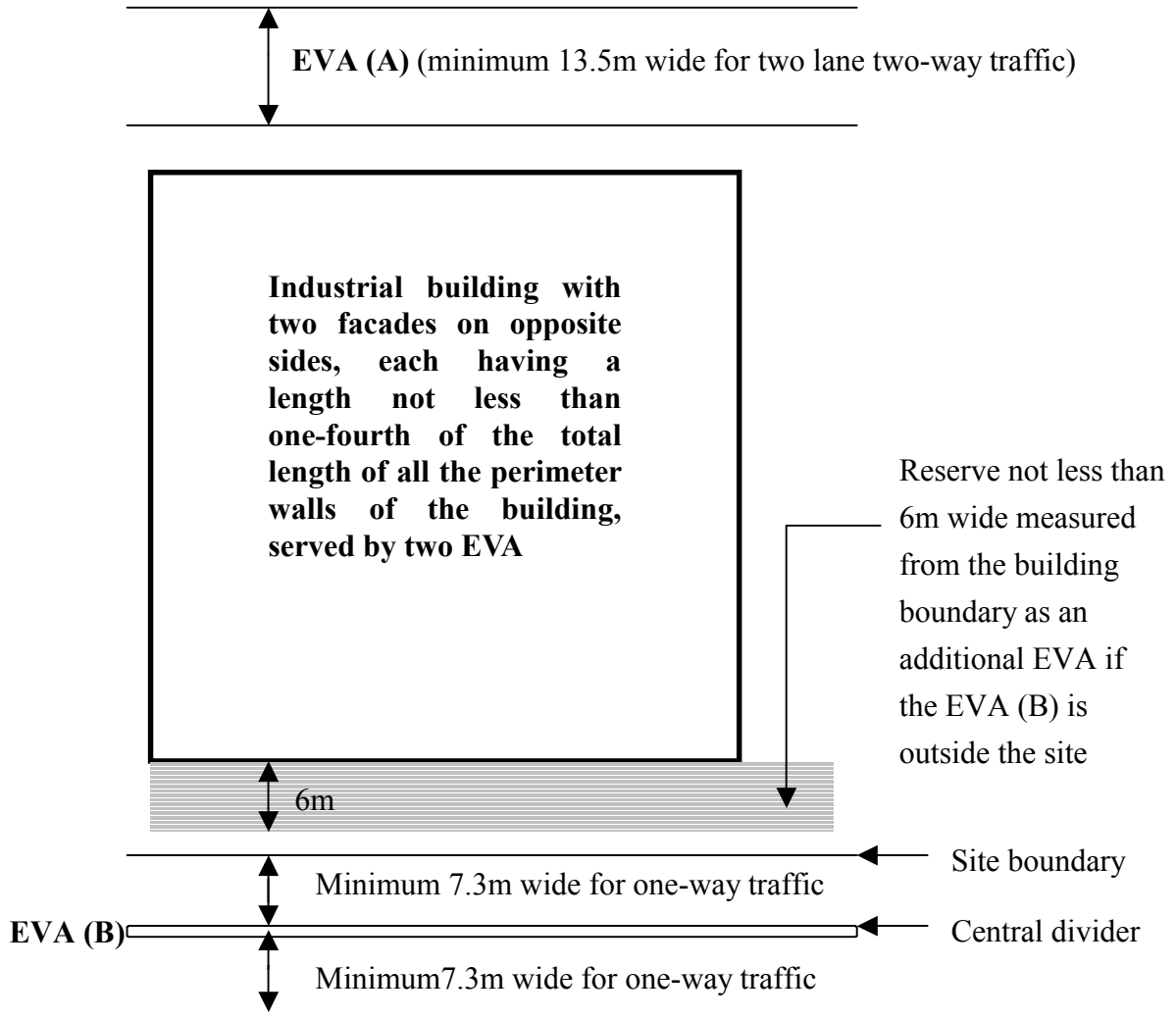

Note: EVA(A) and EVA(B) should be two separate EVAs if access to the site from more than one street is available.

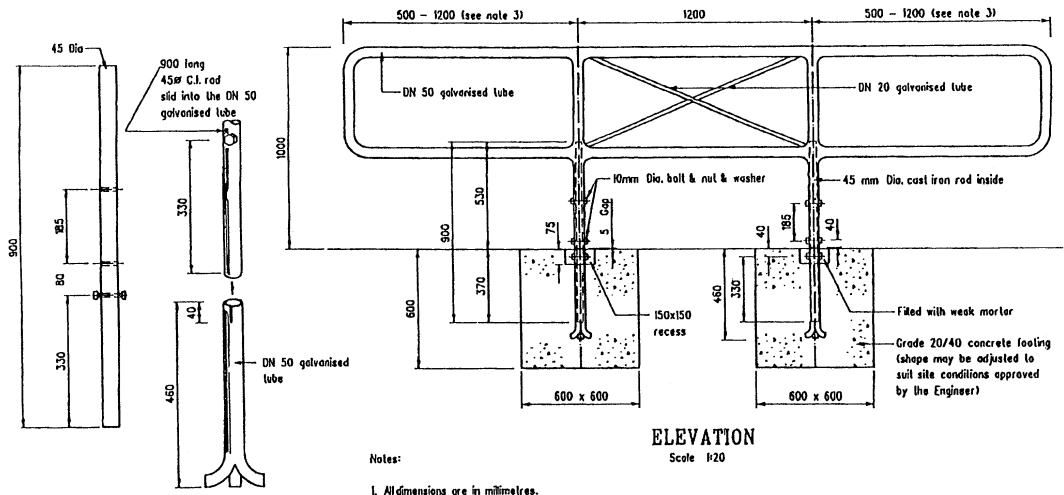

45 DIA. C.I. ROD  
Scale 1:10

- Notes:
1. All dimensions are in millimetres.
  2. Galvanized tube shall be light series to BS. 1387. and painted to system 'D' C.S. clause 16.62 with finished colour in red.
  3. This dimension can be adjusted to suit width of opening.

ELEVATION  
Scale 1:20

EMERGENCY CRASH GATE Paragraph 24.4

Diagram 7



**Diagram 8 Provision of clear space for emergency crash gate (Paragraph 24.4)**

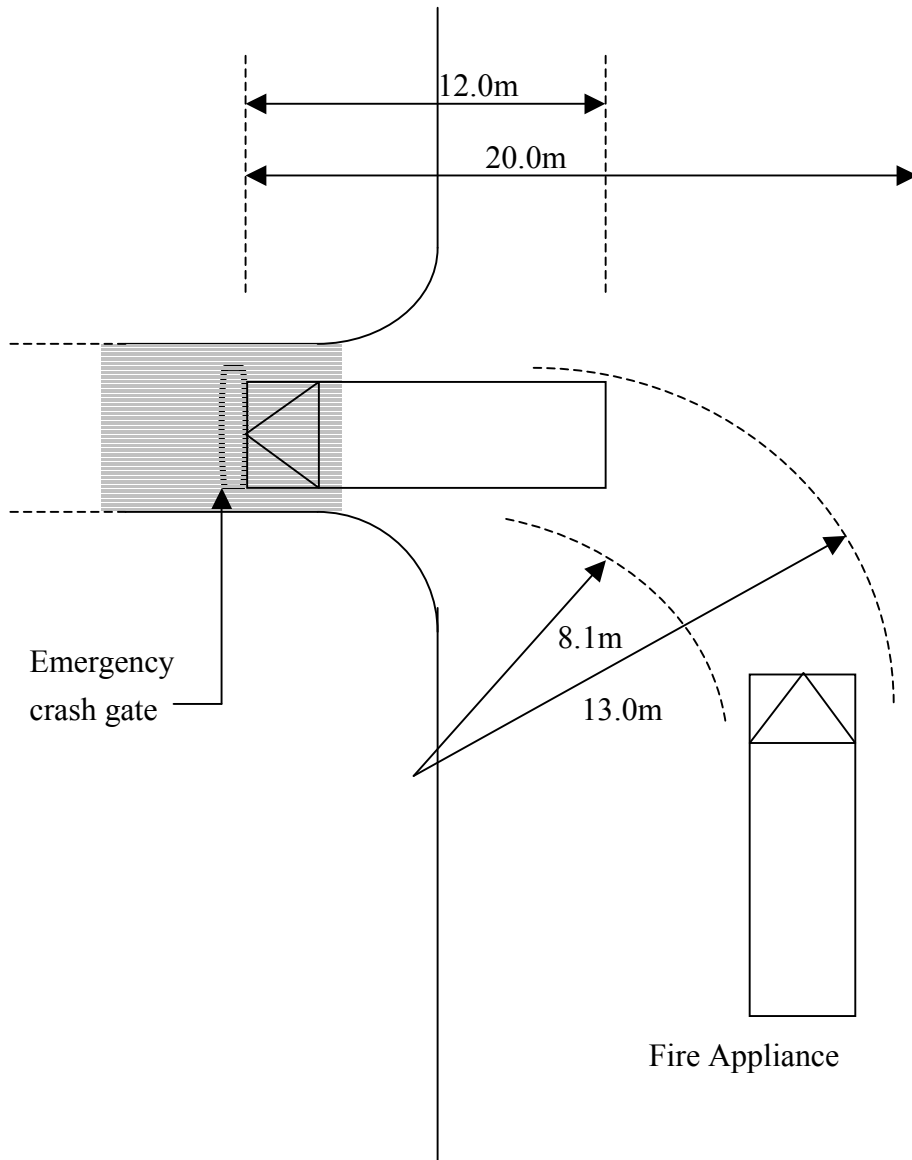
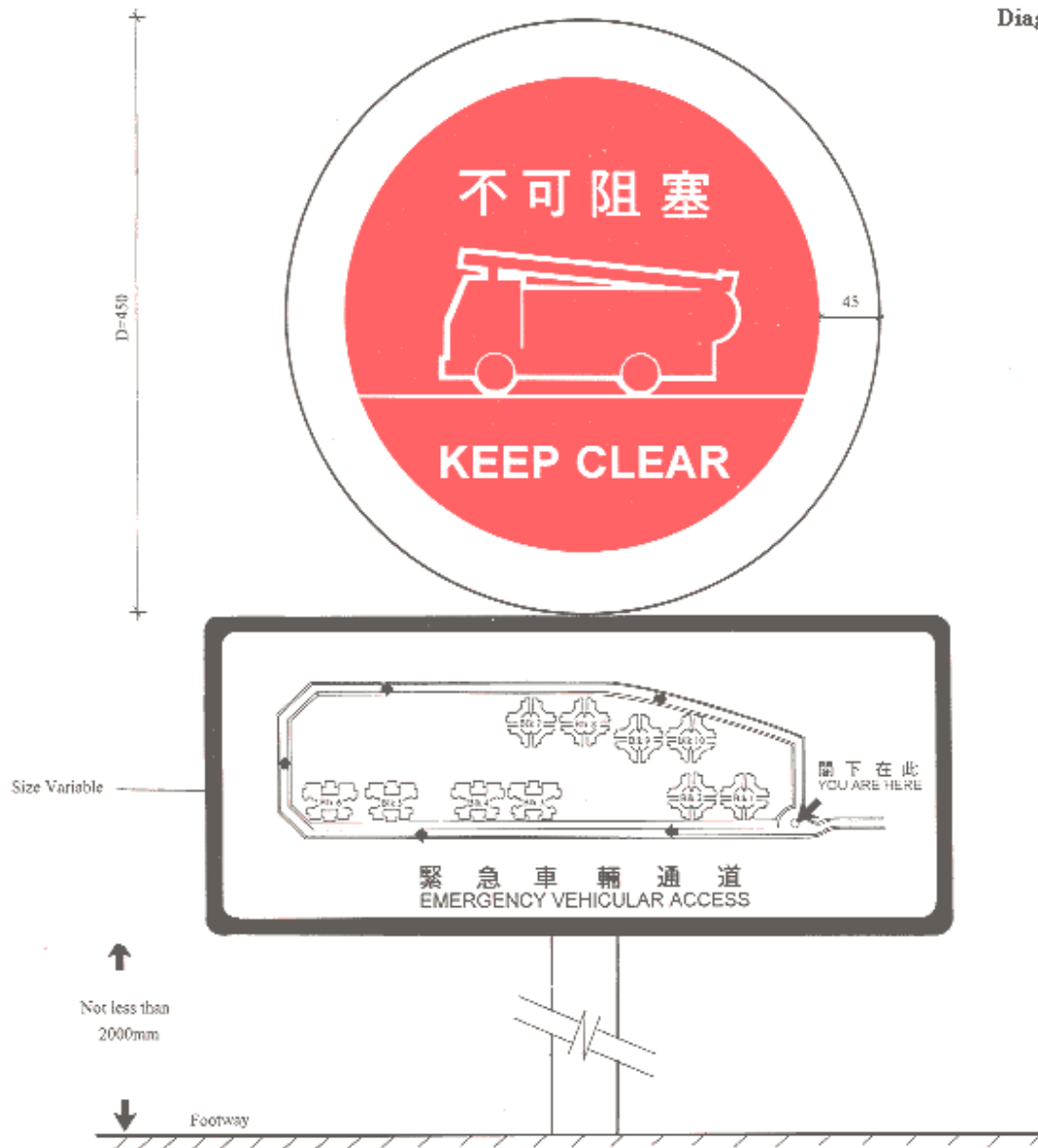

Diagram 9



**EMERGENCY VEHICULAR ACCESS**  
**◆ LAYOUT SIGN AT ENTRANCE OF EVA ◆**

Paragraphs 26.2(a) and 26.3(a)



Diagram 10

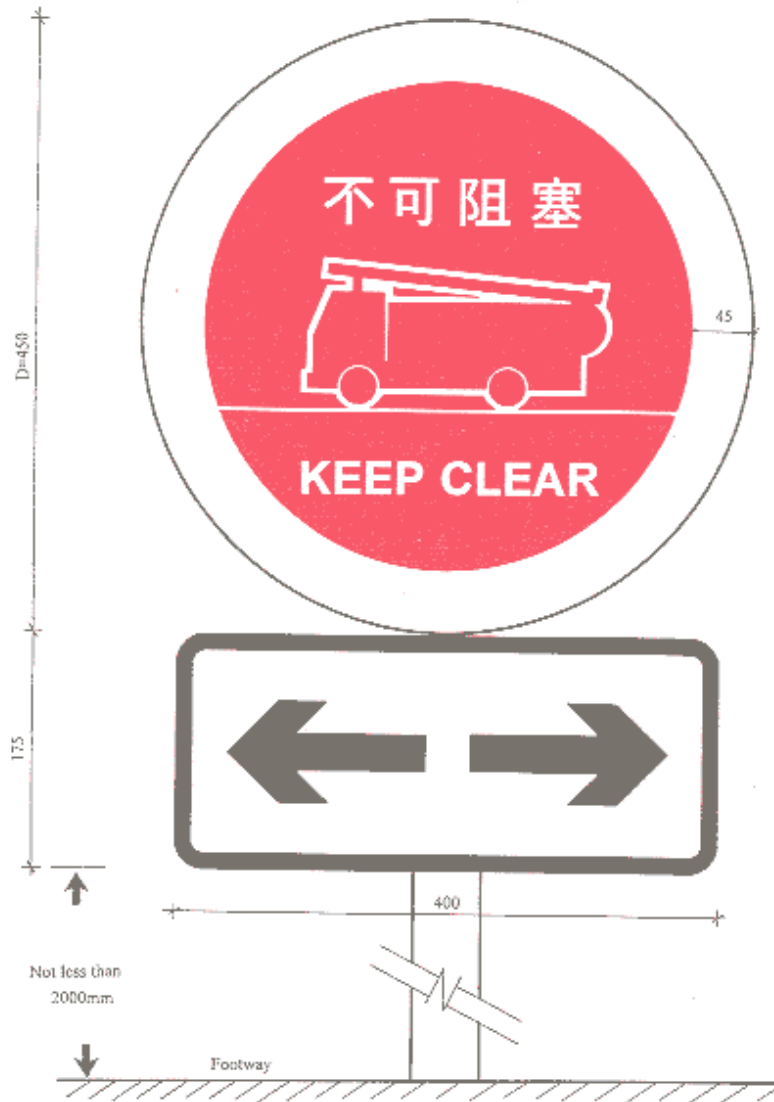

### EMERGENCY VEHICULAR ACCESS

### INDICATION SIGN ALONG EVA IN THE FORM OF CARRIAGEWAY

Paragraph 26.2(b)



Diagram 11

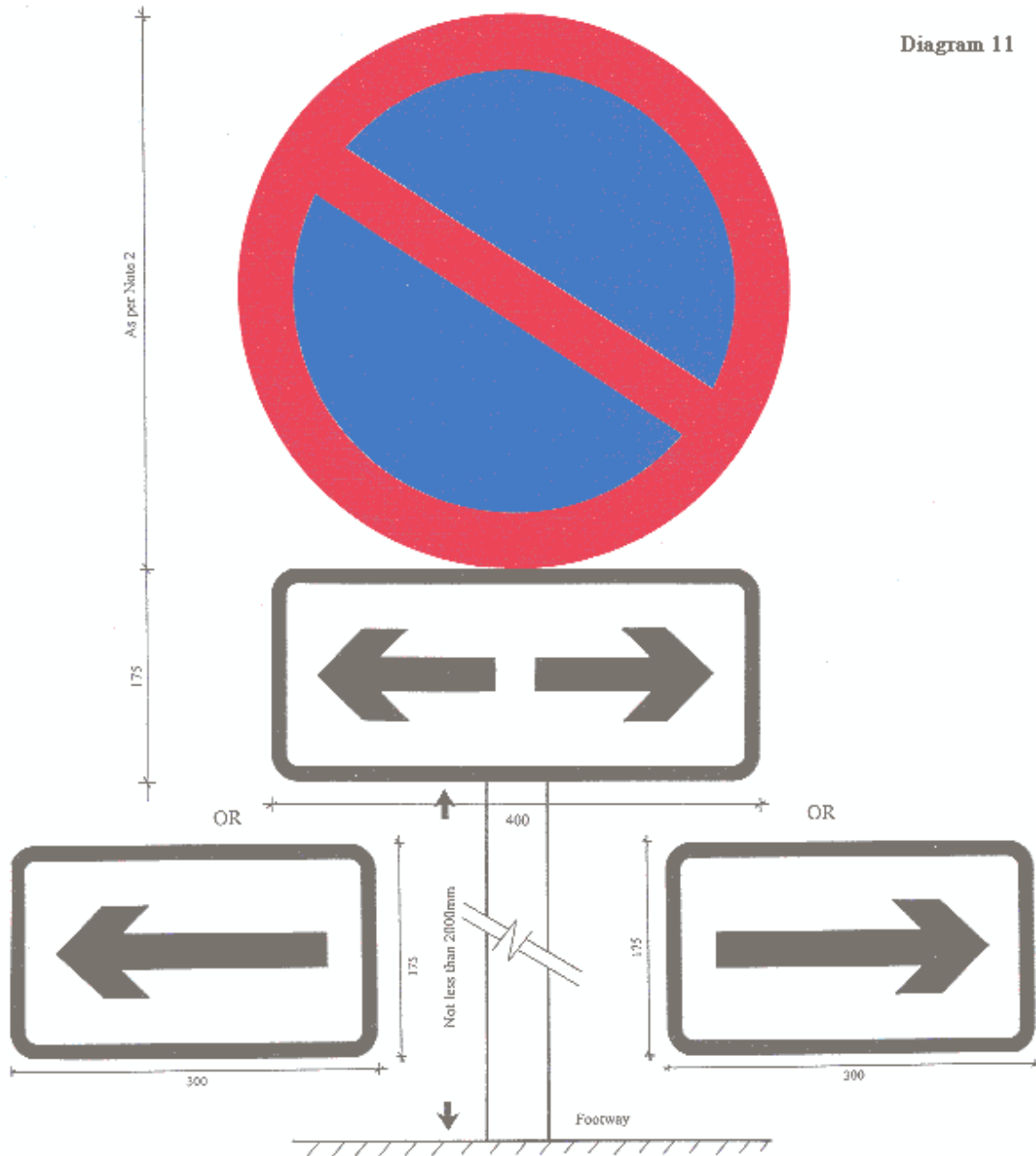

## EMERGENCY VEHICULAR ACCESS

### ◆ NO PARKING SIGN ◆

Paragraph 26.2(c)

0 50 100 150mm

**Notes :**

- 1) The specifications of "No Parking" signs shall follow the provisions in Road Traffic (Parking on Private Roads) Regulations, Cap. 374, Laws of Hong Kong and the Code of Practice for Private Roads.
- 2) The diameter of the "No Parking" sign to be erected at both ends of the EVA shall be 450mm whereas for those in between, signs of 200mm or 300mm diameter may be employed.

Diagram 12



**EMERGENCY VEHICULAR ACCESS**  
**ROUTE SIGN ALONG EVA NOT IN THE FORM OF CARRIAGEWAY**

Paragraph 26.3(b)

