



Code of Practice for
Structural Use of Concrete

2013

(2020 Edition)



**Code of Practice
for
Structural Use of Concrete
2013
(2020 Edition)**



FOREWORD

The Buildings Department (BD) established the Technical Committee on the Code of Practice for Structural Use of Concrete (TC) in January 2008 for the purpose of collecting views and feedbacks on the use of the Code of Practice for Structural Use of Concrete 2004 (the 2004 Code) from the construction industry and with a view to keeping the code of practice in pace with the advancement in design and technology.

This current code of practice, namely the Code of Practice for Structural Use of Concrete 2013 (the 2013 Code) is issued after a five-year review work by the TC, which has focused on four fronts: (a) the advancement in design and technology; (b) the experience gained and the views and feedbacks received on the use of the 2004 Code; (c) the unique characteristics of the properties of local materials, the conditions of the local environment and the practices of the local construction industry; and (d) a series of events that occurred after the 2004 Code was published, such as the issue of the circular letter dated 29 April 2011 by BD on reinforcement fixing details, the carrying out of a comprehensive study on the values of the elastic modulus of concrete by a sub-committee under the TC in 2009, and the issue of Construction Standard CS2:2012.

Although this code of practice is not a statutory document, the compliance with the requirements of this code of practice is deemed to satisfy the relevant provisions of the Buildings Ordinance and related regulations.

The contributions and efforts given by the invited members of the technical committee in the preparation of the 2013 Code are greatly appreciated.

This edition of the 2013 Code incorporates the various amendments made and promulgated through circular letters since its first publication in February 2013 as summarised below:

| Date of Circular Letter | Reference |
|--------------------------------------|---|
| 13 June 2017 (2017 Amendment) | https://www.bd.gov.hk/doc/en/resources/codes-and-references/code-and-design-manuals/OldVersions/CoP_Concrete_ov.zip  |
| 24 November 2020 (2020 Amendment) | |

This edition of the 2013 Code is available for viewing in the Buildings Department website www.bd.gov.hk under the “Codes, design manuals and guidelines” page of the “Resources” section. This code of practice may be downloaded subject to terms and conditions stipulated in the website.

First issue : February 2013

This revision : December 2020

CONTENTS

| | |
|--|-----------|
| FOREWORD | i |
| 1 GENERAL | 1 |
| 1.1 SCOPE | 1 |
| 1.2 REFERENCES | 1 |
| 1.3 ASSUMPTIONS..... | 1 |
| 1.4 GLOSSARY | 2 |
| 1.4.1 General terms..... | 2 |
| 1.4.2 Terms specific to flat slabs (see clause 6.1.5) | 2 |
| 1.4.3 Terms specific to perimeters (see clause 6.1.5.7) | 2 |
| 1.4.4 Terms specific to walls (see clause 6.2.2)..... | 3 |
| 1.4.5 Terms specific to ductility (see clause 9.9)..... | 3 |
| 1.5 SYMBOLS..... | 3 |
| 2 BASIS OF DESIGN | 6 |
| 2.1 REQUIREMENTS | 6 |
| 2.1.1 Aim of design..... | 6 |
| 2.1.2 Design method | 6 |
| 2.1.3 Design process..... | 6 |
| 2.1.4 Robustness..... | 6 |
| 2.1.5 Ductility | 6 |
| 2.1.6 Design working life | 6 |
| 2.1.7 Durability, workmanship and materials..... | 6 |
| 2.1.8 Quality control..... | 7 |
| 2.2 PRINCIPLES OF LIMIT STATE DESIGN..... | 7 |
| 2.2.1 General..... | 7 |
| 2.2.2 Ultimate Limit State (ULS)..... | 7 |
| 2.2.3 Fire Limit States (FLS)..... | 8 |
| 2.2.4 Serviceability Limit States (SLS) | 8 |
| 2.3 LOADS..... | 9 |
| 2.3.1 Design Loads..... | 9 |
| 2.3.2 Loads for Ultimate Limit State (ULS) | 11 |
| 2.3.3 Loads for Serviceability Limit States (SLS) | 12 |
| 2.4 MATERIALS..... | 13 |
| 2.4.1 General | 13 |
| 2.4.2 Characteristic strength of materials..... | 13 |
| 2.4.3 Partial safety factors for material strength, γ_m | 13 |
| 2.5 ANALYSIS AND VERIFICATION | 13 |
| 2.5.1 General | 13 |
| 2.5.2 Limitations..... | 14 |
| 2.6 NEW AND ALTERNATIVE METHODS | 14 |
| 2.6.1 General | 14 |
| 2.6.2 Acceptance requirements..... | 14 |
| 2.6.3 Performance based approach | 14 |
| 3 MATERIALS | 15 |
| 3.1 CONCRETE | 15 |
| 3.1.1 General..... | 15 |
| 3.1.2 Characteristic strength..... | 15 |
| 3.1.3 Strength grades | 15 |
| 3.1.4 Deformation of concrete | 15 |

| | | |
|----------|--|-----------|
| 3.1.5 | Elastic deformation | 16 |
| 3.1.6 | Poisson's ratio | 17 |
| 3.1.7 | Creep | 17 |
| 3.1.8 | Drying shrinkage | 19 |
| 3.1.9 | Thermal expansion | 20 |
| 3.1.10 | Stress-strain relationships for design | 20 |
| 3.2 | REINFORCING STEEL | 20 |
| 3.2.1 | General | 20 |
| 3.2.2 | Characteristic strength | 20 |
| 3.2.3 | Strength classes | 20 |
| 3.2.4 | Elastic modulus | 21 |
| 3.2.5 | Physical properties | 21 |
| 3.2.6 | Stress-strain relationships for design | 21 |
| 3.2.7 | Weldability | 21 |
| 3.2.8 | Mechanical couplers | 21 |
| 3.3 | WELDED FABRIC | 22 |
| 3.3.1 | General | 22 |
| 3.3.2 | Materials, fabrication, sampling and testing | 22 |
| 3.3.3 | Additional requirements for Grade 500A welded fabric | 22 |
| 3.4 | PRESTRESSING TENDONS | 23 |
| 3.4.1 | General | 23 |
| 3.4.2 | Characteristic strength | 23 |
| 3.4.3 | Ductility | 23 |
| 3.4.4 | Physical properties | 23 |
| 3.4.5 | Stress-strain relationships for design | 23 |
| 3.5 | PRESTRESSING DEVICES | 24 |
| 3.5.1 | Anchorage and couplers | 24 |
| 3.6 | NEW MATERIALS | 24 |
| 3.6.1 | General | 24 |
| 3.6.2 | Acceptance requirements | 24 |
| 3.7 | DESIGN STRENGTH AT ELEVATED TEMPERATURES | 24 |
| 4 | DURABILITY AND FIRE RESISTANCE | 26 |
| 4.1 | OBJECTIVES | 26 |
| 4.1.1 | Durability | 26 |
| 4.1.2 | Fire resistance | 26 |
| 4.2 | REQUIREMENTS FOR DURABILITY | 26 |
| 4.2.1 | General | 26 |
| 4.2.2 | Design for durability | 27 |
| 4.2.3 | Exposure conditions | 27 |
| 4.2.4 | Cover | 28 |
| 4.2.5 | Concrete materials and mixes | 30 |
| 4.2.6 | Mix proportions | 31 |
| 4.2.7 | Mix constituents | 32 |
| 4.3 | REQUIREMENTS FOR FIRE RESISTANCE | 33 |
| 4.3.1 | Prevention of spalling in high strength concrete | 34 |
| 5 | STRUCTURAL ANALYSIS | 35 |
| 5.1 | GENERAL PROVISIONS | 35 |
| 5.1.1 | General provisions | 35 |
| 5.1.2 | Methods of analysis | 35 |
| 5.1.3 | Load cases and combinations | 35 |
| 5.1.4 | Imperfections and second order effects | 36 |
| 5.2 | ANALYSIS OF STRUCTURE | 36 |
| 5.2.1 | Idealisation of the structure | 36 |
| 5.2.2 | Analysis of sections for Ultimate Limit States | 41 |

| | | |
|----------|---|------------|
| 5.2.3 | Analysis of sections for Serviceability Limit States | 41 |
| 5.2.4 | Simplifications..... | 41 |
| 5.2.5 | Monolithic frames not providing lateral restraint..... | 41 |
| 5.2.6 | Frames providing lateral stability..... | 42 |
| 5.2.7 | Slabs..... | 42 |
| 5.2.8 | Corbels and nibs..... | 42 |
| 5.2.9 | Redistribution of moments..... | 43 |
| 5.3 | SECOND ORDER EFFECTS WITH AXIAL LOADS | 43 |
| 5.4 | SHEAR WALLS | 43 |
| 5.5 | TRANSFER STRUCTURES..... | 43 |
| 5.6 | PRECAST ELEMENTS | 44 |
| 6 | ULTIMATE LIMIT STATES | 45 |
| 6.1 | MEMBERS IN FLEXURE | 45 |
| 6.1.1 | General | 45 |
| 6.1.2 | Beams..... | 45 |
| 6.1.3 | Solid slabs supported by beams or walls | 52 |
| 6.1.4 | Ribbed slabs..... | 60 |
| 6.1.5 | Flat slabs | 63 |
| 6.2 | MEMBERS AXIALLY LOADED WITH OR WITHOUT FLEXURE | 76 |
| 6.2.1 | Columns..... | 76 |
| 6.2.2 | Walls..... | 86 |
| 6.3 | TORSION AND COMBINED EFFECTS | 90 |
| 6.3.1 | General | 90 |
| 6.3.2 | Calculation of torsional rigidity..... | 90 |
| 6.3.3 | Torsional shear stress | 90 |
| 6.3.4 | Limit to shear stress | 91 |
| 6.3.5 | Reinforcement for torsion | 91 |
| 6.3.6 | Area of torsional reinforcement | 92 |
| 6.3.7 | Spacing and type of links..... | 92 |
| 6.3.8 | Arrangement of longitudinal reinforcement | 92 |
| 6.3.9 | Arrangement of links in T, L or I sections | 92 |
| 6.4 | DESIGN FOR ROBUSTNESS AGAINST DISPROPORTIONATE COLLAPSE | 93 |
| 6.4.1 | Design of Ties..... | 93 |
| 6.4.2 | Bridging elements..... | 94 |
| 6.5 | CORBELS AND NIBS..... | 95 |
| 6.5.1 | General | 95 |
| 6.5.2 | Design..... | 95 |
| 6.5.3 | Continuous concrete nibs | 95 |
| 6.6 | STAIRCASES | 96 |
| 6.6.1 | Loading | 96 |
| 6.6.2 | Design of staircases | 96 |
| 6.7 | FOUNDATIONS..... | 97 |
| 6.7.1 | Assumptions in the design of pad footings and pile caps | 97 |
| 6.7.2 | Design of pad footings..... | 97 |
| 6.7.3 | Design of pile caps | 97 |
| 6.8 | BEAM – COLUMN JOINTS | 99 |
| 6.8.1 | General principles and requirements | 99 |
| 7 | SERVICEABILITY LIMIT STATES | 102 |
| 7.1 | GENERAL..... | 102 |
| 7.1.1 | Introduction | 102 |
| 7.1.2 | Assumptions | 102 |
| 7.1.3 | Loads..... | 102 |
| 7.1.4 | Analysis of structure for serviceability limit states | 103 |

| | | |
|----------|--|------------|
| 7.1.5 | Material properties for the calculation of curvature and stresses..... | 103 |
| 7.2 | CRACKING | 103 |
| 7.2.1 | General | 103 |
| 7.2.2 | Control of cracking without direct calculation (deemed-to-satisfy) | 103 |
| 7.2.3 | Assessment of crack widths | 104 |
| 7.2.4 | Early thermal cracking | 105 |
| 7.3 | DEFORMATIONS | 106 |
| 7.3.1 | General considerations..... | 106 |
| 7.3.2 | Excessive response to wind loads | 106 |
| 7.3.3 | Excessive vibration..... | 107 |
| 7.3.4 | Limiting deflection without direct calculation (deemed-to-satisfy) | 107 |
| 7.3.5 | Calculation of deflection | 109 |
| 7.3.6 | Calculation of curvatures | 112 |
| 8 | REINFORCEMENT: GENERAL REQUIREMENTS | 116 |
| 8.1 | GENERAL | 116 |
| 8.1.1 | Scope..... | 116 |
| 8.1.2 | Bar scheduling..... | 116 |
| 8.1.3 | Permissible deviations on reinforcement fitting between two concrete faces | 116 |
| 8.2 | SPACING OF REINFORCEMENT | 116 |
| 8.3 | PERMISSIBLE INTERNAL RADII FOR BENT BARS | 116 |
| 8.4 | ANCHORAGE OF LONGITUDINAL REINFORCEMENT | 117 |
| 8.4.1 | General | 117 |
| 8.4.2 | Anchorage bond stress..... | 117 |
| 8.4.3 | Design anchorage bond stress..... | 117 |
| 8.4.4 | Values for design ultimate anchorage bond stress | 118 |
| 8.4.5 | Minimum ultimate anchorage bond lengths..... | 118 |
| 8.4.6 | Anchorage by bend or hook | 119 |
| 8.4.7 | Design ultimate anchorage bond stress for welded fabric | 120 |
| 8.4.8 | Minimum support widths..... | 120 |
| 8.5 | ANCHORAGE OF LINKS AND SHEAR REINFORCEMENT | 120 |
| 8.6 | ANCHORAGE BY WELDED BARS..... | 120 |
| 8.7 | LAPS..... | 121 |
| 8.7.1 | General | 121 |
| 8.7.2 | Laps | 121 |
| 8.7.3 | Lap length..... | 122 |
| 8.7.4 | Transverse reinforcement in the lap zone | 124 |
| 8.8 | ADDITIONAL RULES FOR LARGE DIAMETER BARS..... | 125 |
| 8.9 | BUNDLED BARS | 126 |
| 8.9.1 | General | 126 |
| 8.9.2 | Anchorage of bundles of bars..... | 127 |
| 8.9.3 | Lapping bundles of bars | 127 |
| 8.10 | PRESTRESSING TENDONS | 127 |
| 8.10.1 | Arrangement of prestressing tendons and ducts | 127 |
| 8.10.2 | Anchorage of pre-tensioned tendons | 132 |
| 8.10.3 | Anchorage zones of post-tensioned members..... | 132 |
| 8.10.4 | Anchorage and couplers for prestressing tendons | 133 |
| 8.10.5 | Deviators..... | 133 |
| 9 | DETAILING OF MEMBERS AND PARTICULAR RULES | 135 |
| 9.1 | GENERAL | 135 |
| 9.2 | BEAMS | 135 |
| 9.2.1 | Longitudinal reinforcement | 135 |
| 9.2.2 | Shear reinforcement..... | 138 |

| | | |
|-----------|---|------------|
| 9.2.3 | Torsion reinforcement..... | 138 |
| 9.3 | SOLID SLABS..... | 139 |
| 9.3.1 | Flexural reinforcement..... | 139 |
| 9.3.2 | Shear reinforcement..... | 140 |
| 9.4 | CANTILEVERED PROJECTING STRUCTURES | 140 |
| 9.4.1 | General requirements..... | 140 |
| 9.4.2 | Minimum reinforcement..... | 141 |
| 9.4.3 | Anchorage of tension reinforcement | 141 |
| 9.4.4 | Details and construction | 141 |
| 9.5 | COLUMNS | 141 |
| 9.5.1 | Longitudinal reinforcement | 142 |
| 9.5.2 | Transverse reinforcement..... | 142 |
| 9.6 | WALLS..... | 143 |
| 9.6.1 | General | 143 |
| 9.6.2 | Vertical reinforcement..... | 144 |
| 9.6.3 | Horizontal reinforcement | 144 |
| 9.6.4 | Transverse reinforcement..... | 144 |
| 9.6.5 | Plain walls..... | 144 |
| 9.7 | FOUNDATIONS..... | 144 |
| 9.7.1 | Pile caps | 144 |
| 9.7.2 | Column and wall footings | 145 |
| 9.7.3 | Tie beams | 145 |
| 9.7.4 | Bored piles and barrettes | 145 |
| 9.8 | CORBELS..... | 145 |
| 9.8.1 | General | 145 |
| 9.8.2 | Reinforcement anchorage | 145 |
| 9.8.3 | Shear reinforcement..... | 146 |
| 9.8.4 | Resistance to horizontal force | 146 |
| 9.9 | DETAILING FOR DUCTILITY..... | 146 |
| 9.9.1 | Beams..... | 146 |
| 9.9.2 | Columns..... | 148 |
| 9.9.3 | Walls..... | 152 |
| 10 | GENERAL SPECIFICATION, CONSTRUCTION AND WORKMANSHIP | 155 |
| 10.1 | OBJECTIVES..... | 155 |
| 10.2 | CONSTRUCTION TOLERANCES | 155 |
| 10.3 | CONCRETE..... | 157 |
| 10.3.1 | Constituents..... | 157 |
| 10.3.2 | Mix specification | 157 |
| 10.3.3 | Methods of specification, production control and transport..... | 157 |
| 10.3.4 | Sampling, testing and assessing conformity | 157 |
| 10.3.5 | Placing and compacting | 160 |
| 10.3.6 | Curing | 160 |
| 10.3.7 | Concreting in hot weather..... | 161 |
| 10.3.8 | Formwork and falsework | 162 |
| 10.3.9 | Surface finish..... | 163 |
| 10.3.10 | Construction joints | 164 |
| 10.3.11 | Movement joints | 164 |
| 10.4 | REINFORCEMENT..... | 164 |
| 10.4.1 | General | 164 |
| 10.4.2 | Cutting and bending | 164 |
| 10.4.3 | Fixing | 165 |
| 10.4.4 | Surface condition..... | 165 |
| 10.4.5 | Laps and joints | 165 |
| 10.4.6 | Welding..... | 165 |

| | | |
|-----------|---|------------|
| 10.5 | PRESTRESSING STEEL | 166 |
| 10.5.1 | General | 166 |
| 10.5.2 | Transport and storage | 166 |
| 10.5.3 | Fabrication | 167 |
| 10.5.4 | Placing | 167 |
| 10.5.5 | Tensioning | 167 |
| 10.5.6 | Protection and bond of prestressing tendons | 169 |
| 10.5.7 | Grouting | 170 |
| 11 | QUALITY ASSURANCE AND QUALITY CONTROL | 173 |
| 11.1 | SCOPE | 173 |
| 11.2 | QUALITY ASSURANCE | 173 |
| 11.3 | CLASSIFICATION OF THE CONROL MEASURES | 173 |
| 11.3.1 | General | 173 |
| 11.3.2 | Internal control | 173 |
| 11.3.3 | External control | 173 |
| 11.3.4 | Conformity control | 173 |
| 11.4 | VERIFICATION SYSTEMS | 173 |
| 11.5 | CONTROL OF EACH STAGE OF DESIGN AND CONSTRUCTION PROCESS..... | 173 |
| 11.6 | CONTROL OF DESIGN | 174 |
| 11.7 | CONTROL OF PRODUCTION AND CONSTRUCTION | 174 |
| 11.7.1 | Objectives | 174 |
| 11.7.2 | Items of production and construction | 174 |
| 11.7.3 | Elements of production and construction | 174 |
| 11.7.4 | Initial tests | 175 |
| 11.7.5 | Checks during construction | 175 |
| 11.7.6 | Conformity controls..... | 176 |
| 11.7.7 | Control and maintenance of the completed structure | 176 |
| 12 | PRESTRESSED CONCRETE | 177 |
| 12.1 | BASIS OF DESIGN..... | 177 |
| 12.1.1 | General | 177 |
| 12.1.2 | Alternative methods..... | 177 |
| 12.1.3 | Serviceability classification | 177 |
| 12.1.4 | Critical limit state | 177 |
| 12.1.5 | Durability and fire resistance | 177 |
| 12.1.6 | Stability, robustness and other considerations..... | 177 |
| 12.1.7 | Loads | 177 |
| 12.1.8 | Strength of materials | 178 |
| 12.2 | STRUCTURES AND STRUCTURAL FRAMES | 178 |
| 12.2.1 | Analysis of structures | 178 |
| 12.2.2 | Relative stiffness | 178 |
| 12.2.3 | Redistribution of moments..... | 178 |
| 12.3 | BEAMS | 178 |
| 12.3.1 | General | 178 |
| 12.3.2 | Slender beams | 178 |
| 12.3.3 | Continuous beams..... | 179 |
| 12.3.4 | Serviceability limit state for beams | 179 |
| 12.3.5 | Stress limitations at transfer for beams | 181 |
| 12.3.6 | Deflection of beams | 181 |
| 12.3.7 | Ultimate limit state for beams in flexure | 181 |
| 12.3.8 | Design shear resistance of beams | 183 |
| 12.3.9 | Torsion..... | 186 |
| 12.4 | SLABS | 186 |
| 12.4.1 | General | 186 |

| | | |
|-----------|--|------------|
| 12.4.2 | Flat slabs | 186 |
| 12.5 | COLUMNS | 186 |
| 12.6 | TENSION MEMBERS..... | 186 |
| 12.7 | PRESTRESSING..... | 187 |
| 12.7.1 | Maximum initial prestress | 187 |
| 12.7.2 | Deflected tendons in pre-tensioning systems..... | 187 |
| 12.8 | LOSS OF PRESTRESS, OTHER THAN FRICTION LOSSES | 187 |
| 12.8.1 | General | 187 |
| 12.8.2 | Relaxation of steel | 187 |
| 12.8.3 | Elastic deformation of concrete | 188 |
| 12.8.4 | Shrinkage of concrete..... | 188 |
| 12.8.5 | Creep of concrete | 188 |
| 12.8.6 | Draw-in during anchorage | 188 |
| 12.9 | LOSS OF PRESTRESS DUE TO FRICTION..... | 188 |
| 12.9.1 | General | 188 |
| 12.9.2 | Friction in jack and anchorage | 188 |
| 12.9.3 | Friction in the duct due to unintentional variation from the specified profile | 189 |
| 12.9.4 | Friction due to curvature of tendons | 189 |
| 12.9.5 | Lubricants | 190 |
| 12.10 | TRANSMISSION LENGTHS IN PRE-TENSIONED MEMBERS..... | 190 |
| 12.11 | END BLOCKS IN POST-TENSIONED MEMBERS..... | 190 |
| 12.11.1 | General | 190 |
| 12.11.2 | Serviceability limit state | 190 |
| 12.11.3 | Ultimate limit state | 190 |
| 12.12 | CONSIDERATIONS AFFECTING DESIGN DETAILS | 191 |
| 12.12.1 | General | 191 |
| 12.12.2 | Limitations on area of prestressing tendons..... | 191 |
| 12.12.3 | Cover to prestressing tendons..... | 191 |
| 12.12.4 | Spacing of prestressing tendons and ducts | 192 |
| 12.12.5 | Longitudinal reinforcement in prestressed concrete beams..... | 192 |
| 12.12.6 | Links in prestressed concrete beams..... | 192 |
| 12.12.7 | Impact loading | 192 |
| 12.13 | DUCTILITY | 192 |
| 12.13.1 | Beam-column Joints | 192 |
| 12.13.2 | Beams..... | 192 |
| 12.13.3 | Columns..... | 192 |
| 13 | LOAD TESTS OF STRUCTURES OR PARTS OF STRUCTURES | 193 |
| 13.1 | GENERAL..... | 193 |
| 13.2 | TEST LOADS..... | 193 |
| 13.3 | ASSESSMENT OF RESULTS..... | 193 |
| 13.4 | TEST CRITERIA | 193 |
| 13.5 | SPECIAL TESTS | 194 |

ANNEX A ACCEPTABLE STANDARDS

LIST OF TABLES

| | |
|---|-----|
| Table 2.1 - Load combinations and values of γ_f for the ultimate limit state | 11 |
| Table 2.2 - Load factors for fire limit state | 12 |
| Table 2.3 - Values of γ_m for the ultimate limit state and fire limit state | 13 |
| Table 3.1 - Compressive strength grades for normal weight concrete..... | 15 |
| Table 3.2 - Design values of elastic modulus for normal-weight concrete | 16 |
| Table 3.3 - Strength of reinforcement..... | 21 |
| Table 3.4 - Cyclic tension-and-compression test | 22 |
| Table 3.5 - Strength reduction factors for concrete | 24 |
| Table 3.6 - Strength reduction factors for reinforcement..... | 25 |
| Table 3.7 - Strength reduction factors for prestressing tendon | 25 |
| Table 4.1 - Exposure conditions | 28 |
| Table 4.2 - Nominal cover to all reinforcement (including links) and minimum concrete grade to meet durability requirements for reinforced and prestressed concrete | 29 |
| Table 4.3 - Adjustments to minimum cementitious contents for aggregates other than 20 mm nominal maximum size | 30 |
| Table 4.4 - Durability of unreinforced concrete made with normal-weight aggregates of 20 mm nominal maximum size..... | 32 |
| Table 4.5 - Limits of Chloride content of concrete | 33 |
| Table 6.1 - Design ultimate bending moments and shear forces..... | 45 |
| Table 6.2 - Form and area of shear reinforcement in beams | 48 |
| Table 6.3 - Values of v_c design concrete shear stress..... | 49 |
| Table 6.4 - Ultimate bending moment and shear forces in one-way spanning slabs..... | 53 |
| Table 6.5 - Bending moment coefficients for slabs spanning in two directions at right angles, simply supported on four sides..... | 54 |
| Table 6.6 - Bending moment coefficients for rectangular panels supported on four sides with provision for torsion at corners | 55 |
| Table 6.7 - Shear force coefficient for uniformly loaded rectangular panels supported on four sides with provision for torsion at corners | 59 |
| Table 6.8 - Form and area of shear reinforcement in solid slabs..... | 60 |
| Table 6.9 - Minimum thickness of structural toppings | 61 |
| Table 6.10 - Division of design moments in panels of flat slabs | 68 |
| Table 6.11 - Values of β for braced columns..... | 77 |
| Table 6.12 - Values of β for unbraced columns..... | 77 |
| Table 6.13 - Values of β_a | 79 |
| Table 6.14 - Values of the coefficient β | 84 |
| Table 6.15 - Maximum slenderness ratios for reinforced walls | 88 |
| Table 6.16 - Values of coefficient β | 90 |
| Table 6.17 - Values of $v_{t \min}$ and v_{tu} | 91 |
| Table 6.18 - Reinforcement for shear and torsion..... | 92 |
| Table 7.1 - Limitations of maximum estimated surface crack widths | 103 |
| Table 7.2 - Values of external restraint recorded in various structures | 105 |
| Table 7.3 - Basic span/effective depth ratio for reinforced concrete sections..... | 107 |
| Table 7.4 - Modification factor for tension reinforcement | 108 |
| Table 7.5 - Modification factor for compression reinforcement | 108 |
| Table 7.6 - Values of K for various bending moment diagrams | 111 |
| Table 7.7 - Values of ρ_o for calculation of shrinkage curvatures | 114 |
| Table 8.1 - Bar Schedule Dimensions: deduction for permissible deviations | 116 |

| | |
|---|-----|
| Table 8.2 - Minimum bend radii to avoid damage to reinforcement | 117 |
| Table 8.3 - Values of bond coefficient β | 118 |
| Table 8.4 - Ultimate anchorage bond lengths (l_b) as multiples of bar diameter..... | 119 |
| Table 8.5 - Ultimate lap lengths as multiples of bar diameter | 124 |
| Table 8.6 - Minimum cover to ducts perpendicular to plane of curvature | 130 |
| Table 8.7 - Minimum distance between centrelines of ducts in plane of curvature..... | 131 |
| Table 9.1 - Minimum percentages of reinforcement..... | 136 |
| Table 9.2 - Minimum A_{sc} for bored piles and barrettes | 145 |
| Table 10.1 - Sampling Rates | 158 |
| Table 10.2 - Compressive Strength Compliance Criteria | 158 |
| Table 10.3 - Minimum periods of curing and protection | 161 |
| Table 11.1 - Objects of production and construction control..... | 174 |
| Table 12.1 - Design flexural tensile stresses for class 2 members: serviceability limit state: cracking..... | 180 |
| Table 12.2 - Design hypothetical flexural tensile stresses for class 3 members..... | 180 |
| Table 12.3 - Depth factors for design tensile stresses for class 3 members..... | 181 |
| Table 12.4 - Conditions at the ultimate limit state for rectangular beams with pre-tensioned tendons or post-tensioned tendons having effective bond | 183 |
| Table 12.5 - Values of $V_{CO} / b_v h$ | 185 |
| Table 12.6 - Relaxation factors..... | 187 |
| Table 12.7 - Design bursting tensile forces in end blocks..... | 190 |

LIST OF FIGURES

| | |
|---|-----|
| Figure 3.1 - Coefficient K_L (Creep)..... | 18 |
| Figure 3.2 - Coefficient K_m (Creep)..... | 18 |
| Figure 3.3 - Coefficient K_c (Creep and shrinkage) | 18 |
| Figure 3.4 - Coefficient K_e (Creep)..... | 18 |
| Figure 3.5 - Coefficient K_j (Creep and shrinkage) | 18 |
| Figure 3.6 - Coefficient K_L (Shrinkage) | 19 |
| Figure 3.7 - Coefficient K_e (Shrinkage) | 19 |
| Figure 3.8 - Short-term design stress-strain curve for normal weight concrete | 20 |
| Figure 3.9 - Short-term design stress-strain curve for reinforcement..... | 21 |
| Figure 3.10 - Short-term design stress-strain curve for prestressing tendons | 23 |
| Figure 5.1 - Definition of l_{pj} , for calculation of flange width..... | 37 |
| Figure 5.2a - Effective flange width parameters..... | 37 |
| Figure 5.2b - Notations for the connection between flange and web | 38 |
| Figure 5.3 - Effective span (l) for different support conditions | 40 |
| Figure 6.1 - Simplified stress block for concrete at ultimate limit state | 46 |
| Figure 6.2 - System of bent-up bars | 50 |
| Figure 6.3 - Shear failure near supports..... | 51 |
| Figure 6.4 - Effective width of solid slab carrying a concentrated load near an unsupported edge..... | 52 |
| Figure 6.5 - Definition of panels and bays | 53 |
| Figure 6.6 - Division of slab into middle and edge strips..... | 57 |
| Figure 6.7 - Distribution of load on a beam supporting a two-way spanning slabs..... | 58 |
| Figure 6.8 - Types of column head..... | 64 |
| Figure 6.9 - Division of panels in flat slabs | 67 |
| Figure 6.10 - Definition of breadth of effective moment transfer strip b_e for various typical cases..... | 70 |
| Figure 6.11 - Shear at slab column junctions | 71 |
| Figure 6.12 - Application of clauses 6.1.5.6 (b) and (c)..... | 72 |
| Figure 6.13 - Zones for punching shear reinforcement | 75 |
| Figure 6.14 - Shear perimeter of slabs with openings..... | 76 |
| Figure 6.15 - Shear perimeters with loads close to free edge..... | 76 |
| Figure 6.16 - Braced slender columns..... | 81 |
| Figure 6.17 - Unbraced slender columns | 82 |
| Figure 6.18 - Biaxially bent columns..... | 84 |
| Figure 6.18a - Geometry of the Circular Section..... | 85 |
| Figure 6.19 - Critical section for shear check in a pile cap..... | 98 |
| Figure 6.20 - Effective joint widths..... | 100 |
| Figure 7.1 - Assumptions made in calculating curvatures..... | 113 |
| Figure 7.2 - Loading history for serviceability limit state - curvature | 115 |
| Figure 8.1 - Requirements of a bend anchorage..... | 119 |
| Figure 8.2 - Anchorage of links..... | 120 |
| Figure 8.3 - Welded transverse bar as anchoring device..... | 120 |
| Figure 8.4 - Adjacent laps..... | 122 |
| Figure 8.5 - Factors for lapping bars | 123 |
| Figure 8.6 - Transverse reinforcement for lapped splices..... | 125 |
| Figure 8.7 - Additional reinforcement for large diameter bars | 126 |
| Figure 8.8 - Anchorage of widely staggered bars in a bundle | 127 |

| | |
|---|-----|
| Figure 8.9 - Lap joint in tension including a fourth bar | 127 |
| Figure 8.10 - Minimum clear spacing between pre-tensioned tendons..... | 128 |
| Figure 8.11 - Minimum clear spacing between ducts..... | 128 |
| Figure 8.12 - Dispersion of prestress | 133 |
| Figure 9.1 - Placing of tension reinforcement in flanged cross-section..... | 137 |
| Figure 9.2 - Examples of shear reinforcement | 138 |
| Figure 9.3 - Torsion link arrangements..... | 138 |
| Figure 9.4 - Edge reinforcement for a slab | 140 |
| Figure 9.5 - Column transverse reinforcement..... | 143 |
| Figure 9.6 - Typical corbel detailing..... | 146 |
| Figure 9.7 - Typical confinement in beam | 148 |
| Figure 9.7a - Beam-Column Joint Shear Reinforcement | 151 |
| Figure 9.8 - Bar lapping details for column..... | 152 |
| Figure 9.9 - Type 1 mechanical coupler details for column..... | 152 |
| Figure 9.10 - Type 2 mechanical coupler details for column..... | 152 |
| Figure 9.11 - Details of confined boundary elements..... | 154 |

1 GENERAL

1.1 SCOPE

This Code of Practice provides recommendations for the design, construction and quality control of reinforced and prestressed concrete buildings and structures where the concrete is made with normal weight aggregates. It covers the requirements for strength, serviceability, durability and fire resistance, but not other possible requirements such as thermal or acoustic properties.

For bridges and associated structures, reference should also be made to the Structures Design Manual for Highways and Railways issued by the Highways Department.

For structural steel and concrete composite construction, reference should be made to the Code of Practice for Structural Use of Steel.

The design of precast concrete elements and structures is covered in the Code of Practice for Precast Concrete Construction.

The following are outside the scope of this Code of Practice:

- (a) particular aspects of special types of buildings and civil engineering works, such as membrane, composite structures, viaducts, dams, pressure vessels, and reservoirs.
- (b) no fines concrete, aerated concrete, glass fibre reinforced concrete, and concrete containing lightweight or heavy aggregate or structural steel sections.

1.2 REFERENCES

This Code of Practice incorporates provisions from the following documents. These documents are referred to at the appropriate parts of the text. For dated references, subsequent amendments or revisions do not apply. For undated references, the latest edition of the publication applies.

Codes of Practice issued by the Buildings Department, Hong Kong

- (a) Code of Practice for Dead and Imposed Loads
- (b) Code of Practice on Wind Effects in Hong Kong
- (c) Code of Practice for Fire Safety in Buildings
- (d) Code of Practice for Precast Concrete Construction
- (e) Code of Practice for Structural Use of Steel

Construction Standards issued by the Development Bureau, Hong Kong

- (f) Construction Standard CS1: Testing Concrete
- (g) Construction Standard CS2: Steel Reinforcing Bars for the Reinforcement of Concrete
- (h) Construction Standard CS3: Aggregates for Concrete

1.3 ASSUMPTIONS

The procedures given in this Code of Practice are based on the following assumptions:

- (a) the design is carried out by appropriate persons with suitable qualifications and experience;
- (b) adequate supervision and quality control is provided in factories, in plants and at site;
- (c) construction is carried out by persons having the appropriate skill and experience;
- (d) construction materials are used as intended by this Code of Practice or the relevant material or product specification;
- (e) the structure will be adequately maintained; and
- (f) the structure will be used as intended in the design brief.

1.4 GLOSSARY

For the purpose of this Code of Practice, the following glossary of terms apply.

1.4.1 General terms

| | |
|-----------------------------------|---|
| acceptable standards | standards acceptable to the Building Authority (BA) as given in Annex A |
| cantilever projecting structure | a structural element that cantilevers from the main structure for example, canopies, balconies, bay windows, air conditioning platforms etc. |
| cementitious content | the combined mass of cement, silica fume and either pulverised fuel ash or ground granulated blastfurnace slag per cubic metre of compacted concrete. For silica fume, the dry mass shall be used |
| free water/cement ratio | the ratio between the mass of the free water in the concrete mix and the cementitious content |
| design working life | the period of time during which a structure that has undergone normal maintenance is unlikely to require major repairs |
| design service load | the design load used for the serviceability limit states |
| design ultimate load | the design load used for the ultimate limit state |
| fire limit state | the state relating to the structural effects of a fire in a building or part of a building (see clause 2.2.3.1) |
| high strength concrete | concrete of grade above C60 but not exceeding C100 |
| limit state | the state beyond which the structure no longer fulfils the relevant design criteria |
| normal strength concrete | concrete of grade not exceeding C60 |
| serviceability limit states (SLS) | those states relating to specified service requirement for a structure or structural element (see clause 2.2.4.1) |
| type 1 mechanical coupler | mechanical coupler that satisfies the requirements given in clause 3.2.8.3 |
| ultimate limit state (ULS) | that state associated with collapse or with other similar forms of structural failure (see clause 2.2.2.1) |
| welded fabric | arrangement of longitudinal and transverse bars of the same or different nominal diameter arranged substantially at right angles to each other that are welded together at all points of intersection by electrical resistance welding in a factory using automatic machines (see clause 3.3) |

1.4.2 Terms specific to flat slabs

(see clause 6.1.5)

| | |
|-------------|--|
| column head | enlargement of the top of a column which supports the slab over a larger area than the column section alone |
| drop | slab thickening in the region of a column |
| flat slab | a slab supported without beams by columns. The slab may be formed with or without drops and either be solid or the slab soffit may comprise a series of ribs in two directions (waffle or coffered slab) |

1.4.3 Terms specific to perimeters

(see clause 6.1.5.7)

| | |
|---------------------------------|---|
| effective depth | the average effective depth for all effective reinforcement passing through a perimeter |
| effective length of a perimeter | the perimeter length reduced for the effects of any holes or external edges |

| | |
|----------------------|--|
| effective steel area | the total area of tension reinforcement that passes through a zone and that also extends at least one effective depth or 12 times the bar diameter beyond the zone on either side |
| failure zone | an area of slab bounded by two perimeters $1.5d$ apart |
| perimeter | the smallest rectangular boundary that can be drawn round a loaded area which nowhere comes closer to the edges of the loaded area than some specified distance which is a multiple of $0.75d$ |

1.4.4 Terms specific to walls

(see clause 6.2.2)

| | |
|------------------------------|--|
| braced wall | a wall with lateral supports |
| lateral supports | horizontal, vertical or inclined elements (which may be props, buttresses, floors or crosswalls) able to transmit lateral forces from a braced wall to the principal structural bracing or to the foundations |
| plain wall | a concrete wall containing either no reinforcement or insufficient to satisfy the minimum quantities of reinforcement specified in clauses 9.6.1 to 9.6.4 Note: For a 'plain wall', any reinforcement is ignored when considering the strength of the wall. |
| principal structural bracing | shear walls or other suitable bracing which provide lateral stability to the structure as a whole |
| reinforced wall | a concrete wall containing at least the minimum quantities of reinforcement specified in clauses 9.6.1 to 9.6.4 |
| slender wall | a wall other than a stocky wall |
| stocky wall | a wall where the effective height divided by the thickness (l/h) does not exceed 15 (braced) or 10 (unbraced) |
| wall | a vertical load-bearing member whose length is greater than four times its thickness |

1.4.5 Terms specific to ductility

(see clause 9.9)

| | |
|---------------------------|--|
| confined boundary element | the portion of the wall as defined in clause 9.9.3.2 |
| critical zone in beam | the location and extent of beam as specified in clause 9.9.1.1 |
| critical zone in column | the location and extent of column as specified in clause 9.9.2.2 |
| critical zone in wall | the location and extent of wall as specified in clause 9.9.3.1 |
| type 2 mechanical coupler | mechanical coupler with ductility properties that satisfies the requirements given in clause 3.2.8.4 |

1.5 SYMBOLS

The following symbols are the main symbols used throughout this Code of Practice. Other symbols are defined at the locations at which they are used.

| | |
|----------------------|---|
| A_C | gross area of the concrete section |
| A_{CC} | area of the concrete section in compression |
| A_{ps} | area of prestressing tendons in tension zone |
| A_S | area of tension reinforcement |
| $A_{S\text{ prov}}$ | area of tension reinforcement provided |
| $A_{S\text{ req}}$ | area of tension reinforcement required |
| A_{st} | area of transverse reinforcement in a flange |
| A_S' | area of beam compression reinforcement |
| $A_{S'\text{ prov}}$ | area of beam compression reinforcement provided |

| | |
|-----------------------|---|
| $A_{s' \text{ req}}$ | area of beam compression reinforcement required |
| A_{sb} | cross-sectional area of bent-up bars |
| A_{sc} | area of longitudinal reinforcement (A_{sc} hence denotes main reinforcement in column, wall or pile. It does not necessarily imply that the reinforcement will be in compression.) |
| A_{sv} | area of shear reinforcement |
| b | breadth of section |
| b_c | effective width of a section in compression (either b or b_{eff}) |
| b_e | breadth of effective moment transfer strip (see Figure 6.10) |
| b_{eff} | effective flange width of a T or L beam |
| b_w | average web width of a beam |
| C_x, C_y | plan dimensions of a column |
| d | effective depth of the tension reinforcement |
| d' | effective depth to the compression reinforcement |
| E_n | nominal earth load |
| F | design ultimate load (e.g. $1.4G_k + 1.6Q_k$) |
| f_{cu} | characteristic compressive strength of concrete |
| f_{pb} | design tensile stress in the tendons |
| f_{pe} | design effective prestress in the tendons after all losses |
| f_{pu} | characteristic strength of a prestressing tendon |
| f_s | estimated design service stress in the tension reinforcement |
| f_y | specified characteristic yield strength |
| f_{yv} | characteristic yield strength of the shear reinforcement |
| G_k | characteristic dead load |
| h | depth of cross section measured in the plane under consideration, or thickness of wall |
| h_{agg} | maximum size of coarse aggregate |
| h_f | thickness of a beam flange |
| l | effective span of a beam or slab |
| l_b | basic anchorage length for reinforcement |
| l_e | effective height of a column or wall in the plane of bending considered |
| M | design ultimate moment at the section considered |
| N | design ultimate axial force |
| n_b | number of bars in a reinforcement bundle |
| Q_k | characteristic imposed load |
| R_m | tensile strength |
| s_b | spacing of bent-up bars |
| s_f | spacing of the flange transverse reinforcement |
| s_v | spacing of links along the member |
| V | design ultimate shear force |
| V_b | design shear resistance of bent-up bars |
| W_k | characteristic wind load |
| x | depth to the neutral axis of a concrete section |
| z | lever arm |
| α_{min} | modification factor for minimum steel ratio for tensile reinforcement and transverse reinforcement |
| γ_f | partial safety factor for load |

| | |
|--------------------------|---|
| γ_m | partial safety factor for strength of materials |
| v | design shear stress at a section |
| v_c | design ultimate resistance shear stress of the concrete |
| v_{sf} | longitudinal shear stress at the interface between one side of a flange and the web |
| v_{sx} | design end shear on strips of unit width and span l_x |
| v_{sy} | design end shear on strips of unit width and span l_y |
| β_{vx}, β_{vy} | shear force coefficients |
| ϕ | diameter of reinforcing bar or prestressing duct |
| ϕ_n | equivalent diameter of a bundle of reinforcing bar |
| Δ_x | longitudinal length of the flange beam (see Figure 5.2b) |
| ΔF_d | change of compressive force in the flange (see Figure 5.2b) |

2 BASIS OF DESIGN

2.1 REQUIREMENTS

2.1.1 Aim of design

The aim of design is to ensure that with an acceptable level of probability a structure will, during its intended design working life, perform satisfactorily. With an appropriate degree of reliability and in an economical way, a structure should:

- (a) sustain all loads and deformations likely to occur during construction and use;
- (b) remain fit for the purpose of its intended use;
- (c) have adequate durability for its environment;
- (d) have adequate structural resistance for the required fire resistance period; and
- (e) have resistance to the effects of accidental or deliberate misuse such that it will not be damaged to an extent that is disproportionate to the original cause.

2.1.2 Design method

The design method outlined in this code of practice is the limit state design method. In addition, consideration should be given to the requirement for durability, ductility and fire resistance. Equally important are the consideration of suitable materials, workmanship and quality control.

2.1.3 Design process

The attainment of design objectives requires compliance with defined standards for materials, production, workmanship, maintenance and use of the structure. Design, construction and service use should be considered as a whole and the performance requirements should be clearly defined, wherever possible, early in the design process.

2.1.4 Robustness

A structure should be designed and constructed so that it is inherently robust and not unreasonably susceptible to the effects of accidents or misuse, and disproportionate collapse.

2.1.5 Ductility

The structure should be designed and constructed so that it has a certain degree of ability to deform beyond elastic limit without excessive strength or stiffness degradation.

2.1.6 Design working life

The design working life should be clearly identified. This Code of Practice assumes a design working life of 50 years, which is deemed appropriate for general buildings and other common structures. Where, the design working life differs from this value, the recommendations should be modified as appropriate.

2.1.7 Durability, workmanship and materials

The structure shall be designed such that deterioration over its design working life does not impair the performance of the structure below that intended, having due regard to its environment and the anticipated level of maintenance (see section 4). In order to achieve an adequately durable structure, the following should be taken into account:

- (a) the intended or foreseeable use of the structure;
- (b) the required design criteria;
- (c) the expected environmental conditions;
- (d) the composition, properties and performance of the materials and products;
- (e) the properties of the soil;
- (f) the choice of the structural system;
- (g) the shape of members and the structural detailing;
- (h) the quality of workmanship, and the level of control;
- (i) the particular protective measures; and
- (j) the intended maintenance during the design working life.

The environmental conditions shall be identified at the design stage so that their significance can be assessed in relation to durability and adequate provisions can be made for protection of the materials used in the structure.

It is assumed that the quality of the concrete, steel and other materials and of the workmanship, as verified by inspections, is adequate for safety, serviceability and durability (see section 10).

2.1.8 Quality control

In order to provide a structure that corresponds to the requirements and to the assumptions made in the design, appropriate quality management measures should be in place (see section 11). These measures comprise:

- (a) definition of the reliability requirements;
- (b) organisational measures; and
- (c) controls at the stages of design, construction, use and maintenance.

2.2 PRINCIPLES OF LIMIT STATE DESIGN

2.2.1 General

This Code of Practice uses the limit state design method. A limit state can be defined as the state beyond which the structure no longer fulfils the relevant design criteria. Well-detailed and properly-erected structures designed by the limit state method will have acceptable probabilities that they will not reach a limit state. Limit states considered in this Code of Practice are either the ultimate limit state (ULS) or the serviceability limit states (SLS), the meanings of which are described in clauses 2.2.2 and 2.2.3 below. The usual approach is to design for the most critical limit state, usually the ultimate limit state, and then to check that the remaining limit states will not be reached.

2.2.2 Ultimate Limit State (ULS)

2.2.2.1 Definition

Ultimate limit state (ULS) is defined in clause 1.4.1. It is related to the safety of people and the safety of the structure. The ultimate limit state is concerned with the strength, stability, collapse, overturning, and buckling of the structure.

2.2.2.2 Structural Stability

The structure should be so designed that adequate means exist to transmit the design ultimate dead, wind and imposed loads safely from the highest supported level to the foundations. The layout of the structure and the interaction between the structural members should be such as to ensure a robust and stable design. The designer responsible for the overall stability of the structure should ensure the compatibility of the design and details of parts and components, even where some or all of the design and details of those parts and components are not made by this designer.

The design loads and the design strengths of materials should be those given in clauses 2.3 and 2.4, as appropriate for the ULS. The design should satisfy the requirement that no ultimate limit state is reached by rupture of any section, by overturning or by buckling of individual members under the worst combination of ultimate loads. Account should be taken of elastic or plastic buckling, or sway when appropriate.

2.2.2.3 Robustness

(a) General

Structures should be planned and designed so that they are not unreasonably susceptible to the effects of accidents. In particular, situations should be avoided where damage to small areas of a structure or failure of single elements may lead to collapse of major parts of the structure.

Unreasonable susceptibility to the effects of accidents may generally be prevented if the following precautions are taken:

- (i) the layout of buildings are checked to avoid any inherent weakness;
- (ii) all buildings are capable of safely resisting the notional horizontal design ultimate load as given in clause 2.3.1.4 applied at each floor or roof level simultaneously;
- (iii) all buildings are provided with effective horizontal ties (see clause 6.4.1):
 - (1) around the periphery;
 - (2) internally;
 - (3) to columns and walls.

Where for any reason it is not feasible to introduce ties, the following procedures should be adopted:

- (iv) the layout of buildings are checked to identify any key elements the failure of which would cause the collapse of more than a limited portion close to the element in question. Where

such elements are identified and the layout cannot be revised to avoid them, the design should take their importance into account. Key elements should be designed, constructed and protected as necessary to prevent removal by accident. The design loads for key elements are given in clauses 2.3.1.4 (b) and (c);

- (v) buildings are detailed so that any vertical load-bearing element other than a key element can be removed without causing the collapse of more than a limited portion close to the element in question. This is generally achieved by the provision of vertical ties in accordance with clause 6.4 in addition to satisfying the criteria stated above. There may, however, be cases where it is inappropriate or impossible to provide effective vertical ties in all or some of the vertical load-bearing elements. Where this occurs, each such element should be considered to be removed in turn and elements normally supported by the element in question designed to 'bridge' the gap in accordance with the provisions of clause 6.4.2.

(b) Check of structural integrity

A careful check should be made and appropriate action taken to ensure that there is no inherent weakness of structural layout and that adequate means exist to transmit the dead, imposed and wind loads safely from the highest supported level to the foundations.

(c) Safeguarding against vehicular impact

Where vertical elements are at risk from vehicle impact, consideration should be given to the provision of additional protection, such as bollards, earth banks or other devices. Otherwise they should be designed in accordance with clause 2.3.1.4 (d).

2.2.2.4 *Special Hazards*

The design for a particular occupancy, location or use, e.g. chemical plant, may need to allow for the effects of particular hazards or for any unusually high probability of the structure surviving an accident even though damaged. In such cases, partial safety factors greater than those given in clauses 2.3 and 2.4 may be required.

2.2.3 **Fire Limit States (FLS)**

2.2.3.1 *Definition*

Fire limit state (FLS) is defined in clause 1.4.1. It is the state relating to the structural effects of a fire in a building or part of a building

2.2.3.2 *Check of structural integrity*

The structural integrity of the building and its members should be checked for the effects of the design fire. In the checking, the strength of concrete and reinforcement should be based on the values given in clause 3.7, and the partial safety factors for loads and materials should be based on the values given in clauses 2.3.2.7 and 2.4.3.2 respectively.

Note: Fire limit state is required to be checked if the cover of concrete members does not comply with the provisions of the Code of Practice for Fire Safety in Buildings or the design strength of concrete is greater than 60 MPa.

2.2.4 **Serviceability Limit States (SLS)**

2.2.4.1 *Definition*

Serviceability limit states (SLS) are defined in clause 1.4.1. They are concerned with:

- (a) the functioning of structure or structural elements under normal use;
- (b) the comfort of users; and
- (c) the appearance of the structure.

Typical serviceability limit states concern deformation (deflection), durability, fire resistance, cracking and vibration. In assessing serviceability limit states, consideration should be given to the effects of temperature, creep, shrinkage, sway, settlement and cyclic loading as appropriate.

2.2.4.2 *Deflection due to vertical loading*

The deformation of the structure or any part of it should not adversely affect its efficiency or appearance. Deflections should be compatible with the degree of movement acceptable by other elements including finishes, services, partitions, glazing and cladding; in some cases a degree of minor repair work or fixing adjustment to such elements may be acceptable. Where specific attention is required to limit deflections to particular values, reference should be made to the detailed

calculations provided in clause 7.3.5; otherwise it will generally be satisfactory to use the span/effective depth ratios given in clause 7.3.4.

2.2.4.3 *Response to wind loads*

The effect of lateral deflection should be considered, particularly for a tall, slender structure. However the accelerations associated with the deflection may be more critical than the deflection itself. Limiting criteria for deflection and accelerations of tall building are given in clause 7.3.2.

2.2.4.4 *Cracking*

(a) Reinforced concrete

Cracking should be kept within reasonable bounds by attention to detail. It will normally be controlled by adherence to the detailing rules given in clause 8.2 and section 9 and the deemed to satisfy rules given in clause 7.2.2. Where specific attention is required to limit the design crack width to particular values, reference should be made to clause 7.2.

(b) Prestressed concrete

In the assessment of the likely behaviour of a prestressed concrete structure or element the amount of flexural tensile stress determines its class, as follows:

- (i) class 1: no flexural tensile stresses;
- (ii) class 2: flexural tensile stresses but no visible cracking; and
- (iii) class 3: flexural tensile stresses but surface width of cracks not exceeding 0.1 mm for members in very aggressive environments (e.g. exposure to sea) and not exceeding 0.2 mm for all other members.

2.2.4.5 *Vibration*

Discomfort or alarm to occupants, structural damage, and interference with proper function should be avoided. Isolation of the source of vibration or of part or all of the structure may be needed. Flexible structural elements may require special consideration. Clause 7.3.3 contains guidance on acceptable levels of vibration.

2.2.4.6 *Fatigue*

When the imposed load on a structure is predominantly cyclic it may be necessary to consider the effects of fatigue.

2.2.4.7 *Durability and Fire Resistance*

For requirements for durability and fire resistance refer to section 4.

2.3 **LOADS**

2.3.1 **Design Loads**

2.3.1.1 *Characteristic values of loads*

The following loads should be used in design:

- (a) characteristic dead load, G_k , which shall be taken as the dead loads calculated in accordance with the Code of Practice for Dead and Imposed Loads;
- (b) characteristic imposed load, Q_k , which shall be taken as the imposed loads stipulated in the Code of Practice for Dead and Imposed Loads; and
- (c) characteristic wind load, W_k , as defined in the Code of Practice on Wind Effects.

2.3.1.2 *Nominal earth loads*

Nominal earth loads, E_n , should be obtained in accordance with normal practice and basic engineering principles.

2.3.1.3 *Partial safety factors for loads, γ_f*

The design load for a given type of loading and limit state is obtained from:

$$\gamma_f G_k \text{ or } \gamma_f Q_k \text{ or } \gamma_f W_k \text{ or } \gamma_f E_n$$

where:

γ_f is the appropriate partial safety factor. It is introduced to take account of unconsidered possible increases in load, inaccurate assessment of load effects, unforeseen stress redistribution, variation in

dimensional accuracy and the importance of the limit state being considered. The value of γ_f chosen also ensures that the serviceability requirements can generally be met by simple rules.

2.3.1.4 *Design loads for robustness*

(a) Notional horizontal load

All buildings should be capable of resisting a notional design ultimate horizontal load applied at each floor (including roof) level simultaneously equal to 1.5% of the characteristic dead weight of the structure between mid-height of the storey below and either mid-height of the storey above or the roof surface for the uppermost floor [i.e. the design ultimate wind load should not be taken as less than this value when considering load combinations 2 or 3 (see clause 2.3.2.1)].

(b) Loads on key element

Appropriate design loads should be chosen having regard to the importance of the key element and the likely consequences of its failure, but in all cases an element and its connections should be capable of withstanding a design ultimate load of 34 kN/m², to which no partial safety factor should be applied, from any direction. A horizontal member, or part of a horizontal member that provides lateral support vital to the stability of a vertical key element, should also be considered a key element. For the purposes of this clause, the area to which these loads are applied will be the projected area of the member (i.e. the area of the face presented to the loads).

(c) Key elements supporting attached building components

Key elements supporting attached building components should also be capable of supporting the reactions from any attached building components also assumed to be subject to a design ultimate loading of 34 kN/m². The reaction should be the maximum that might reasonably be transmitted having regard to the strength of the attached component and the strength of its connection.

(d) Vehicular impact

Where vertical elements are to be designed for vehicular impact the nominal design load shall be as specified in Buildings (Construction) Regulation 17.

2.3.1.5 *Exceptional loads*

If in the design it is necessary to consider the probable effects of excessive loads caused by misuse or accident only those loads likely to be acting simultaneously need be considered. The loads considered should be those likely to occur before temporary or permanent measures are taken to repair or offset the effect of the damage.

For these exceptional cases all the following should be taken into account:

- (a) dead load;
- (b) one third of the wind load; and
- (c) for buildings used predominantly for storage or industrial purposes or where the imposed loads are permanent, 100% of the imposed load; for other buildings, one-third of the imposed load.

2.3.1.6 *Differential settlement of foundations*

Where their effects are deemed to be critical to the performance of the structure, the effects of differential settlement between foundations should be taken into consideration. These should be calculated as appropriate based on the geometrical and material properties of the foundations and the geotechnical soil parameters. Loads induced by differential settlement should be treated as permanent.

Examples of where differential settlement can occur include:

- (a) pad foundations in soft ground;
- (b) different types of foundation;
- (c) different foundation depths; and
- (d) insufficient rigidity of pile cap.

2.3.1.7 *Loads during construction*

The loading conditions during erection and construction should be considered in design and should be such that the structure's subsequent conformity to the limit state requirements is not impaired.

2.3.2 Loads for Ultimate Limit State (ULS)

2.3.2.1 Design loads

For ULS design of the whole or any part of a structure each of the combinations of loading given in Table 2.1 should be considered and the design of cross-sections based on the most severe stresses produced.

| Load combination | | Load type | | | | | |
|------------------|---|-----------|------------|---------|------------|--------------------------|------|
| | | Dead | | Imposed | | Earth and water pressure | Wind |
| | | Adverse | Beneficial | Adverse | Beneficial | | |
| 1 | Dead and imposed (and earth and water pressure) | 1.4 | 1.0 | 1.6 | 0 | 1.4 | - |
| 2 | Dead and wind (and earth and water pressure) | 1.4 | 1.0 | - | - | 1.4 | 1.4 |
| 3 | Dead, imposed and wind (and earth and water pressure) | 1.2 | 1.0 | 1.2 | 0 | 1.2 | 1.2 |

Notes:

- Where the earth or water pressure is beneficial, γ_f should not exceed 1.0. (The value of γ_f should be taken such that $\gamma_f \times$ the design earth or water pressure = the actual earth or water pressure.)
- Where differential settlement is considered, the value of γ_f should be the value used for earth and water pressure (see clause 2.3.2.3)

Table 2.1 - Load combinations and values of γ_f for the ultimate limit state

For load combinations 1 and 2 in Table 2.1, the 'adverse' γ_f is applied to any loads that tend to produce a more critical design condition while the 'beneficial' γ_f is applied to any loads that tend to produce a less critical design condition at the section considered. For load combinations 2 and 3, see clause 2.3.1.4 (a) for minimum horizontal load.

2.3.2.2 Effect of exceptional loads or localised damage

For assessing the effects of excessive loads (see clause 2.3.1.5) caused by misuse or accident, γ_f should be taken as 1.05 on the defined loads. When considering the continued stability of a structure after it has sustained localised damage, γ_f should also be taken as 1.05.

2.3.2.3 Differential settlement of foundations

For ultimate limit states, differential settlements need only be considered where they are significant or where second order effects are of importance. In most other cases they need not be considered at ULS, provided that the ductility and rotation capacity of the structural elements is sufficient.

Where differential settlements are taken into consideration, the value of γ_f should be the value used for earth and water pressure (see Table 2.1).

2.3.2.4 Creep, shrinkage, and temperature effects

For ultimate limit states, creep, shrinkage and temperature effects need only be considered where they are significant, for example, for the verification of ultimate limit states of stability where second order effects are of importance. In most other cases they need not be considered at ULS, provided that the ductility and rotation capacity of the structural elements are sufficient. Where creep, shrinkage and temperature effects are taken into consideration, γ_f should be taken as 1.0 for adverse conditions.

2.3.2.5 Fatigue

For fatigue loads, γ_f , should be taken as 1.0 for adverse conditions.

2.3.2.6 Vehicular impact

Where vertical elements are to be designed for vehicular impact γ_f at ULS should be 1.25.

2.3.2.7 Fire

In checking the structural integrity of building or its members for fire limit state, γ_f values should be taken from Table 2.2.

| Loads | γ_f |
|--|------------|
| Dead load | 1.00 |
| Imposed loads: | |
| a) permanent: | |
| 1) those specifically allowed for in design, e.g. plant, machinery and fixed partitions | 1.00 |
| 2) in storage buildings or areas used for storage in other buildings (including libraries and designated filing areas) | 1.00 |
| b) non-permanent: | |
| 1) in escape stairs and lobbies | 1.00 |
| 2) all other areas | *0.80 |
| Wind loads | 0.33 |
| Note: *The value may be reduced to 0.50 when suitable justification is available | |

Table 2.2 - Load factors for fire limit state

2.3.3 Loads for Serviceability Limit States (SLS)

2.3.3.1 General

For most cases, if the simplified rules for design and detailing of reinforcement outlined in sections 7, 8 and 9 respectively are followed then no further checks on SLS are required. Where further checks are necessary then γ_f given in the following clauses should be followed.

2.3.3.2 Dead load

Generally, it is sufficient to take the characteristic value of dead load i.e. γ_f should be taken as 1.0.

2.3.3.3 Imposed load

Generally, it is sufficient to take the characteristic value of imposed load i.e. γ_f should be taken as 1.0.

When calculating deflections, it is necessary to assess how much of the imposed load is transitory and how much is permanent. The proportion of imposed load that should be considered as permanent will depend upon the type of use of the structure. It is suggested that for normal domestic or office occupancy, 25% of the imposed load should be considered as permanent and for structures used for storage, at least 75% of the imposed load should be considered as permanent when the upper limit of deflection is being assessed.

2.3.3.4 Differential settlement of foundations

Where the effects of differential settlements are considered, γ_f should be taken as 1.0 for adverse conditions.

2.3.3.5 Creep, shrinkage, and temperature effects

Where the effects of creep, shrinkage and temperature effects are considered, γ_f should be taken as 1.0 for adverse conditions.

2.4 MATERIALS

2.4.1 General

Materials should conform to acceptable standards and comply with the requirements given in this Code of Practice.

2.4.2 Characteristic strength of materials

Material strengths and properties are defined in section 3.

2.4.3 Partial safety factors for material strength, γ_m

2.4.3.1 General

For the analysis of sections, the design strength for a given material and limit state is derived from the characteristic strength divided by γ_m , where γ_m is the appropriate partial safety factor given in clauses 2.4.3.2 and 2.4.3.3. γ_m takes account of differences between actual and laboratory values, local weaknesses and inaccuracies in assessment of the resistance of sections. It also takes account of the importance of the limit state being considered.

2.4.3.2 Values of γ_m for ultimate limit state (ULS) and fire limit state (FLS)

(a) Material design strengths

In the assessment of the strength of a structure or any of its parts or cross-sections, appropriate γ_m values should be taken from Table 2.3.

| Material/design consideration | Values of γ_m for ULS | Values of γ_m for FLS |
|---|------------------------------|------------------------------|
| Reinforcement (prestressing steel included) | 1.15 | 1.00 |
| Concrete in flexure or axial load | 1.50 | 1.10 |
| Concrete shear strength without shear reinforcement | 1.25 | 1.10 |
| Bond strength | 1.40 | 1.10 |
| Others (e.g. bearing stress) | ≥ 1.50 | ≥ 1.10 |

Table 2.3 - Values of γ_m for the ultimate limit state and fire limit state

(b) Effects of exceptional loads or localised damage

In the consideration of these effects γ_m may be taken as 1.3 for concrete in flexure and 1.0 for steel.

2.4.3.3 Values of γ_m for serviceability limit states (SLS)

(a) General

Values of γ_m for serviceability limit states may be taken as 1.0 except where stated otherwise in particular clauses.

(b) Prestressed concrete criteria for tensile stress criteria

In assessing the cracking strength for a class 2 member, γ_m should be taken as 1.3 for concrete in tension due to flexure. Allowable design stresses are given in clause 12.3.4.

2.5 ANALYSIS AND VERIFICATION

2.5.1 General

When using the limit state method, it shall be verified that for all relevant design situations no relevant limit state is exceeded by the actions resulting from the loadings as calculated using the appropriate γ_f specified in clause 2.3 and with material strengths as modified by γ_m specified in clause 2.4.

The analysis that is carried out to justify a design can be divided into two stages:

(a) analysis of the structure; and

(b) analysis of sections.

Guidelines for the analysis of structures are given in section 5. Rules for analysis of sections for ULS and SLS are given in sections 6 and 7 respectively.

2.5.2 Limitations

The use of the rules given in this code of practice is limited to ultimate and serviceability limit state verifications of structures and structural members subject to static loading, or where the dynamic effects, such as those produced by wind loads, are assessed using equivalent quasi-static loads. For non-linear and dynamic analysis etc further specialist guidance should be sought.

2.6 NEW AND ALTERNATIVE METHODS

2.6.1 General

The requirements of this code of practice are not to be construed as prohibiting the use of new and alternative methods.

2.6.2 Acceptance requirements.

New and alternative methods must be adequately demonstrated to comply with the basic requirements of clause 2.1.

2.6.3 Performance based approach

2.6.3.1 General

Where a performance based approach is adopted, adequate information, including proposals on compliance testing, must be provided to demonstrate that the aim of design specified in clause 2.1.1 will be achieved in the completed structure.

2.6.3.2 Design by testing

Where the adequacy of the design is to be demonstrated by testing:

(a) Model tests

Provided the work is carried out by experienced engineers using suitable equipment, a design may be considered satisfactory on the basis of results from an appropriate model test together with model analysis to predict the behaviour of the actual structure.

(b) Prototype tests

Where the analytical or empirical basis of the design has been justified by development testing of relevant prototype units and structures, the design may be considered satisfactory.

3 MATERIALS

3.1 CONCRETE

3.1.1 General

This section applies to normal and high strength concretes made from locally available natural aggregates.

3.1.2 Characteristic strength

Unless otherwise stated in this Code of Practice, the characteristic strength of concrete is that value of the cube strength at 28 days below which 5% of all compressive test results would be expected to fall.

3.1.3 Strength grades

For the purposes of this Code of Practice, the grade of concrete is the characteristic strength as defined in clause 3.1.2.

The recommended strength grades to be used in specifications are given in Table 3.1.

For reinforced concrete the lowest grade that should be used is C20 for concrete made with normal weight aggregate.

| Concrete strength grade | Minimum characteristic strength (N/mm ²) |
|-------------------------|---|
| C20 | 20 |
| C25 | 25 |
| C30 | 30 |
| C35 | 35 |
| C40 | 40 |
| C45 | 45 |
| C50 | 50 |
| C55 | 55 |
| C60 | 60 |
| C65 | 65 |
| C70 | 70 |
| C75 | 75 |
| C80 | 80 |
| C85 | 85 |
| C90 | 90 |
| C95 | 95 |
| C100 | 100 |

Table 3.1 - Compressive strength grades for normal weight concrete

3.1.4 Deformation of concrete

Where it is necessary to reliably predict the deformation of structural concrete, assessments of elastic, creep, shrinkage and thermal strains are required. The creep and shrinkage of concrete depend mainly on the ambient humidity, the dimensions of the element and the composition of the concrete. Creep is also influenced by the age of the concrete at loading, and the duration and magnitude of the load.

Thus a knowledge of both environmental and loading history is required for accurate predictions of deformation.

Clauses 3.1.5 to 3.1.9 give general guidance on the predictions of the different strain components. This guidance is considered satisfactory to assess movements and deformations for the majority of structures. If an accurate prediction of these strains is considered to be an essential part of the design, this should be obtained from tests carried out on actual concrete similar to that used in the structure.

3.1.5 Elastic deformation

The elastic deformations of concrete largely depend on its composition, particularly the aggregates. The elastic modulus is also affected by the aggregate/cement ratio and the age of the concrete. The values given in Table 3.2 are sufficiently accurate for general application. They may also be used for estimating loss of prestress (see section 12). If the structure is likely to be sensitive to deviations in these values, the values should be specifically assessed. The value chosen in any particular case should depend on the importance of the estimate and why it is needed.

The design values for normal-weight concrete in Table 3.2 are derived from the following equation, which is applicable for concrete of cube strengths between 20 and 100 N/mm²:

$$E_c = 3.46\sqrt{f_{cu}} + 3.21 \quad 3.1$$

where:

E_c is the short-term static modulus of elasticity,

f_{cu} is the cube compressive strength in N/mm².

| Concrete strength grade | E_c (kN/mm ²) | |
|-------------------------|-----------------------------|---|
| | For general use | For checking overall building deflection (see note 2) |
| C20 | 18.7 | 20.5 |
| C25 | 20.5 | 22.2 |
| C30 | 22.2 | 23.7 |
| C35 | 23.7 | 25.1 |
| C40 | 25.1 | 26.4 |
| C45 | 26.4 | 27.7 |
| C50 | 27.7 | 28.9 |
| C55 | 28.9 | 30.0 |
| C60 | 30.0 | 31.1 |
| C65 | 31.1 | 32.2 |
| C70 | 32.2 | 33.2 |
| C75 | 33.2 | 34.2 |
| C80 | 34.2 | 35.1 |
| C85 | 35.1 | 36.0 |
| C90 | 36.0 | 36.9 |
| C95 | 36.9 | 37.8 |
| C100 | 37.8 | 38.7 |

Note:

- Where the mean or characteristic value of elastic modulus is required, the appropriate mean or characteristic strength should be selected from this table.
- E_c value for checking overall building deflection may also be used to check the relative lateral deflection at the transfer structure level as required in clause 5.5.

Table 3.2 - Design values of elastic modulus for normal-weight concrete

3.1.6 Poisson's ratio

Where linear elastic analysis is appropriate, Poisson's ratio may be taken as 0.2.

3.1.7 Creep

The creep strain in concrete ε_{cc} at a particular time after casting can be predicted from:

$$\varepsilon_{cc} = \frac{\text{stress}}{E_{28}} \times \phi_c \quad 3.2$$

where:

E_{28} is the 28-day value of concrete secant modulus which may be taken from Table 3.2,

ϕ_c is the creep coefficient, see equation 3.3.

$$\phi_c = K_L K_m K_c K_e K_j \quad 3.3$$

where:

K_L is the coefficient relating to environment conditions, see Figure 3.1,

K_m is the coefficient relating to the hardening (maturity) of the concrete, see Figure 3.2,

K_c is the coefficient relating to the composition of the concrete, see Figure 3.3,

K_e is the coefficient relating to the effective thickness of the section, see Figure 3.4,

K_j is the coefficient defining the development of creep relative to time, see Figure 3.5.

The values of creep which are for plain concrete, should be multiplied by the reinforcement coefficient K_s to obtain the corresponding values for reinforced concrete:

$$K_s = \frac{1}{1 + \rho \alpha_e} \quad 3.4$$

where:

α_e is the modular ratio E_s/E_c ,

ρ is the steel ratio A_s/A_c ,

A_s is the total area of longitudinal reinforcement,

A_c is the gross cross-sectional concrete area,

E_s is the modulus of elasticity of the reinforcement,

E_c is the short-term modulus of the concrete.

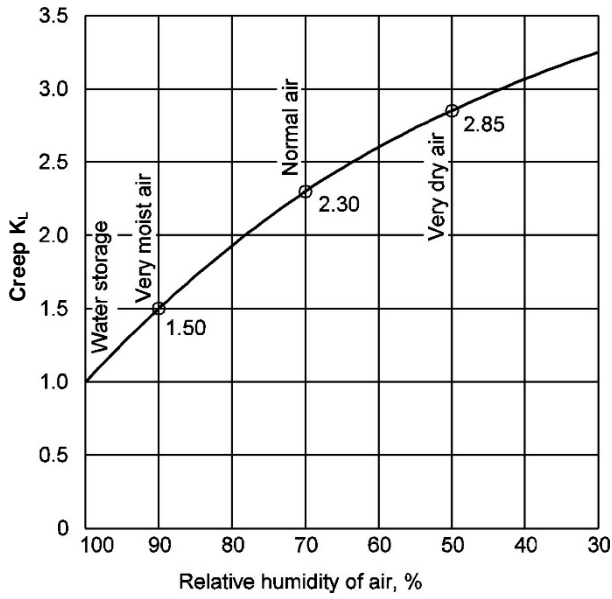

Figure 3.1 - Coefficient K_L (Creep)

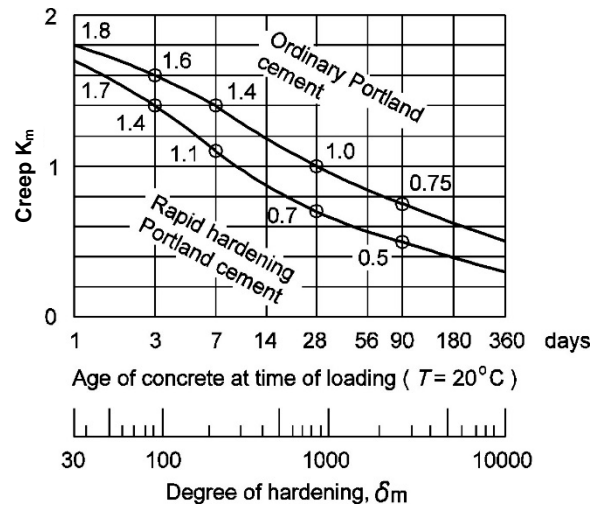

Figure 3.2 - Coefficient K_m (Creep)

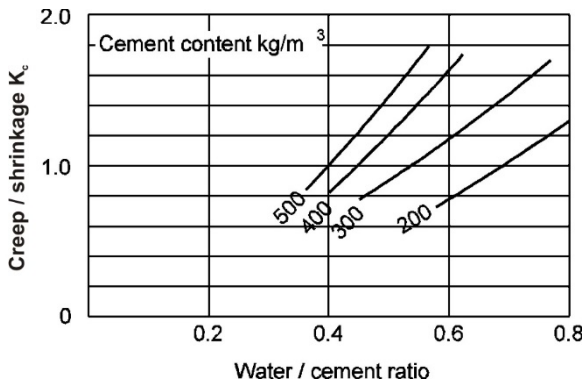

Figure 3.3 - Coefficient K_c (Creep and shrinkage)

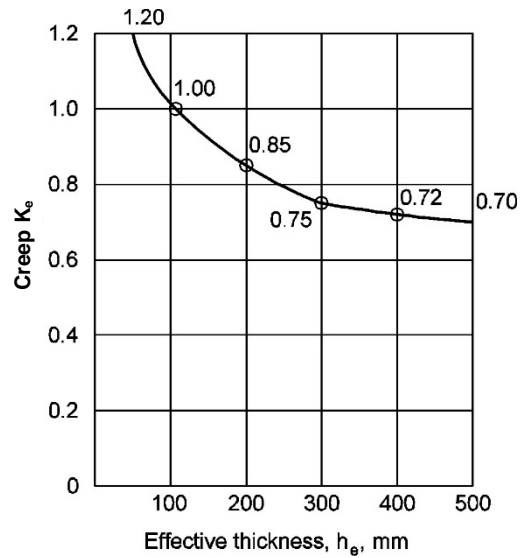

Figure 3.4 - Coefficient K_e (Creep)

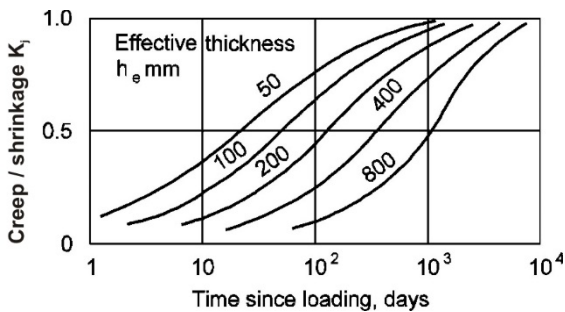

Figure 3.5 - Coefficient K_j (Creep and shrinkage)

The effective section thickness, h_e , is the ratio of the area of the section to the semi-perimeter, $u/2$, in contact with the atmosphere. If one of the dimensions of the section under consideration is very large compared with the other, the effective thickness corresponds approximately to the actual thickness (e.g. for a slab).

If the dimensions are not constant along the member, an average effective thickness can be defined by paying particular attention to those sections in which the stresses are highest.

In individual cases, judgement, based on experience, is essential in interpreting these data; this judgement will depend on the importance of the estimate and why it is needed. It may be advisable to consider a range of values to bracket the problem, since an overestimate may be just as bad as an underestimate. Stresses and relative humidities may vary considerably during the lifetime of the structure and appropriate judgements should be made where detailed calculations are carried out.

3.1.8 Drying shrinkage

An estimate of the drying shrinkage strain of plain concrete ϵ_{CS} at any instant is given by the product of five partial coefficients:

$$\epsilon_{CS} = c_s K_L K_C K_e K_j \tag{3.5}$$

where:

c_s is 2.5, Hong Kong modification factor to allow for properties of the crushed granitic aggregate,

K_L is the coefficient relating to the environment, see Figure 3.6,

K_C is the coefficient relating to the composition of the concrete, see Figure 3.3,

K_e is the coefficient relating to the effective thickness of the section, see Figure 3.7,

K_j is the coefficient defining the development of shrinkage relative to time, see Figure 3.5.

The shrinkage to be expected over an interval of time should be taken as the difference between the shrinkage calculated for the beginning and the end of the interval.

The values of shrinkage, which are for plain concrete, should be multiplied by the reinforcement coefficient K_s to obtain the corresponding shrinkage strain for reinforced concrete. See equation 3.4.

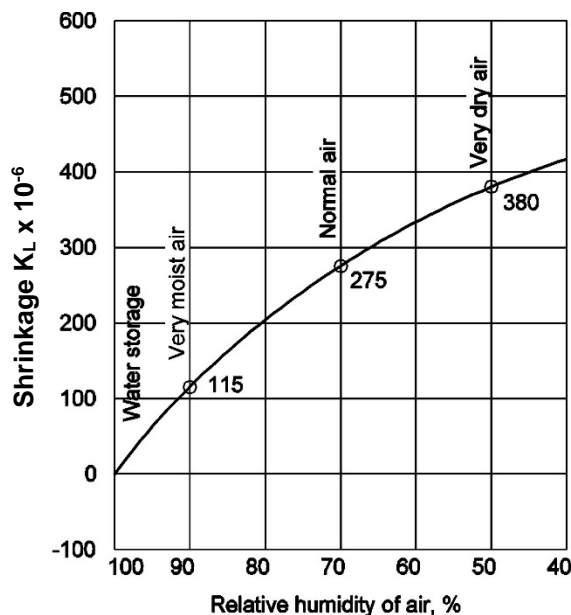

Figure 3.6 - Coefficient K_L
(Shrinkage)

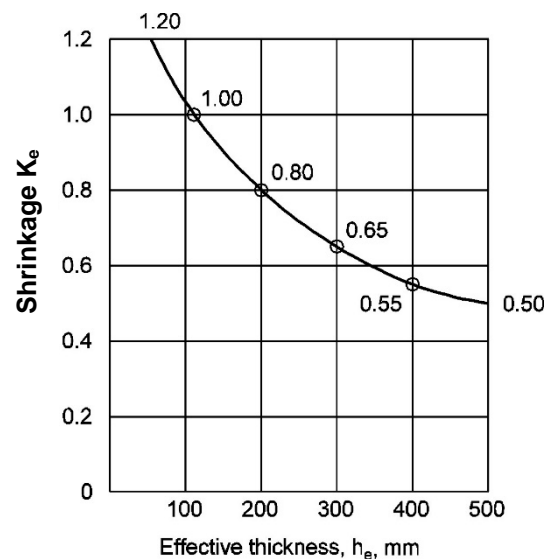

Figure 3.7 - Coefficient K_e
(Shrinkage)

3.1.9 Thermal expansion

The linear coefficient of thermal expansion for normal weight concrete may normally be taken as $10 \times 10^{-6}/^{\circ}\text{C}$.

If the estimate is exceptionally important, the coefficient should be determined for the concrete mix actually used, with due allowance for the effect of moisture content.

3.1.10 Stress-strain relationships for design

The short term design stress-strain curves for design of sections in normal weight concretes are given in Figure 3.8 below, with γ_m having the relevant value.

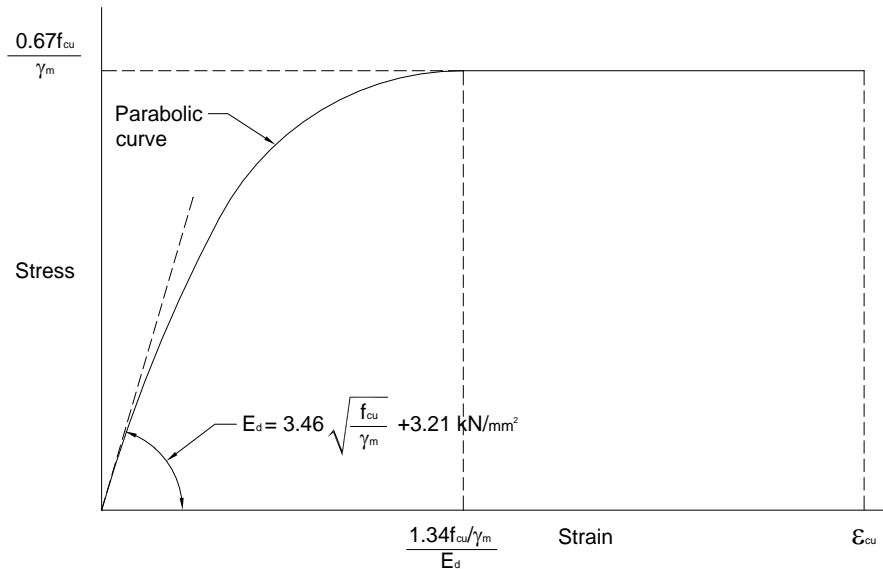

Notes :

1. 0.67 takes account of the relationship between the cube strength and the bending strength in a flexural member. It is simply a coefficient and not a partial safety factor.
2. f_{cu} is in N/mm^2
3. For $f_{cu} \leq 60 \text{ MPa}$, $\epsilon_{cu} = 0.0035$
For $f_{cu} > 60 \text{ MPa}$, $\epsilon_{cu} = 0.0035 - 0.00006 \times \sqrt{(f_{cu} - 60)}$

Figure 3.8 - Short-term design stress-strain curve for normal weight concrete

When sustained loading is being considered, refer to the information provided at clauses 3.1.7 and 3.1.8 on creep and shrinkage.

3.2 REINFORCING STEEL

3.2.1 General

This section applies to plain steel reinforcing bars in grade 250 and ribbed steel reinforcing bars in grade 500B and grade 500C complying with CS2, or the acceptable standards as appropriate, used as reinforcement in concrete structures.

3.2.2 Characteristic strength

The characteristic strength of reinforcement, unless stated otherwise, means the proof or yield strength below which 5% of all possible test results would be expected to fall.

3.2.3 Strength classes

The specified characteristic yield strengths are given in Table 3.3.

| Grade | Specified characteristic yield strength, f_y (N/mm ²) |
|--------------|--|
| 250 | 250 |
| 500B 500C | 500 |

Table 3.3 - Strength of reinforcement

3.2.4 Elastic modulus

The elastic modulus for reinforcement should be taken as 200 kN/mm².

3.2.5 Physical properties

The following mean values may be used:

- (a) density 7850 kg/m³; and
- (b) coefficient of thermal expansion $12 \times 10^{-6}/^{\circ}\text{C}$.

3.2.6 Stress-strain relationships for design

The short-term design stress-strain curve for reinforcement is given in Figure 3.9 below, with γ_m having the relevant value. This curve may also be used for sustained loading.

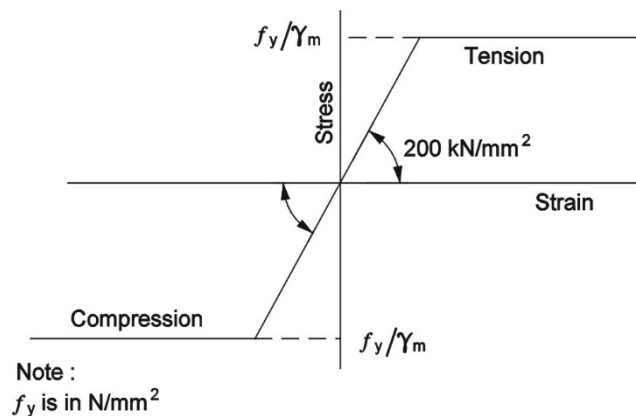

Figure 3.9 - Short-term design stress-strain curve for reinforcement

3.2.7 Weldability

Reinforcement may be considered weldable provided the types of steel have the required welding properties given in the acceptable standards. Welding to be inspected and approved by a competent person.

Where the weldability is unknown, tests should be carried out.

3.2.8 Mechanical couplers

3.2.8.1 General

Mechanical couplers are classified as.

- (a) Type 1 mechanical couplers that conform to clause 3.2.8.3.
- (b) Type 2 mechanical couplers that conform to clause 3.2.8.4.

3.2.8.2 Butt jointed bars in compression only

The load may be transferred between butt jointed bars by means of end bearing where sawn square cut ends are held in contact by means of a suitable sleeve or other coupler.

3.2.8.3 Performance of type 1 mechanical couplers

Type 1 mechanical coupler satisfying the following criteria may be used as an alternative to tension or compression laps:

- (a) when a representative gauge length assembly comprising reinforcement of the diameter, grade and profile to be used, and a coupler of the precise type to be used, is tested in tension the permanent elongation after loading to $0.6f_y$ should not exceed 0.1 mm; and
- (b) the coupled bar assembly tensile strength should exceed 287.5 N/mm^2 for grade 250, 540 N/mm^2 for grade 500B and 575 N/mm^2 for grade 500C.

3.2.8.4 Performance of type 2 mechanical couplers

Type 2 mechanical coupler should satisfy the following criteria:

- (a) The splicing assemblies shall be tested to establish that they comply with the requirements given in clause 3.2.8.3.
- (b) Static tension test: The splicing assemblies must develop in tension the greater of 100 percent of the tensile strength, R_m , of the bar, and 125 percent of the specified characteristic yield strength, f_y , of the bar
- (c) Static compression test: The splicing assemblies must develop in compression 125 percent of the specified characteristic yield strength, f_y , of the bar.
- (d) Cyclic tension-and-compression test: The splicing assemblies shall be tested in four stages as given in Table 3.4, and must sustain Stages 1 through 3 without failure. If the conditions of acceptance for the static tension test are complied with in Stage 4, the static tension test may be omitted.

The use of type 2 mechanical coupler should comply with the requirements given in clause 9.9.

| Stage | Tension | Compression | Cycles |
|--|----------------------------|-------------|--------|
| 1 | $0.95f_y$ | $0.5f_y$ | 20 |
| 2 | $2\varepsilon_y$ | $0.5f_y$ | 4 |
| 3 | $5\varepsilon_y$ | $0.5f_y$ | 4 |
| 4 | Load in tension to failure | | |
| Notes: | | | |
| 1. ε_y is the strain of reinforcing bar at actual yield stress. | | | |
| 2. The actual ultimate tensile strength of the bar is obtained by testing samples from a referenced reinforcing bar. The test samples are obtained from the same referenced reinforcing bar. | | | |

Table 3.4 - Cyclic tension-and-compression test

3.3 WELDED FABRIC

3.3.1 General

Unless otherwise stated, the requirements for steel reinforcing bars apply to welded fabric. In each single panel of welded fabric, the bars should be of the same characteristics (type and grade). Bars of different diameters could be used in different directions but only one nominal diameter should be used in each direction.

3.3.2 Materials, fabrication, sampling and testing

The material properties of Grade 500A steel reinforcing bars used for manufacturing the welded fabric should comply with BS 4449 while those of Grade 500B and Grade 500C steel reinforcing bars used for manufacturing the welded fabric should comply with CS2. The fabrication, sampling and testing other than material properties for all welded fabric, i.e. Grade 500A, 500B and 500C should comply with BS 4483. Determination of fatigue properties of steel reinforcing bars used for manufacturing the welded fabric is an optional requirement on the basis of the type of structure in which the welded fabrics are to be cast.

3.3.3 Additional requirements for Grade 500A welded fabric

Grade 500A welded fabric should be manufactured by steel reinforcing bars with diameters from 8 mm to 16 mm. In all conditions, moment redistribution is not allowed.

In addition, Grade 500A welded fabric should only be used in the following locations:

(a) Slab

- (i) sections not contributing to the lateral load resisting system;
- (ii) sections other than column strips of flat slab system and similar slab structures providing structural ties for robustness against disproportionate collapse; and
- (iii) slab sections with low bending stress, i.e.

$$K = \frac{M}{f_{cu}bd^2} \leq 0.156 \quad \text{for } f_{cu} \leq 45 \text{ N/mm}^2$$

$$\leq 0.120 \quad \text{for } 45 < f_{cu} \leq 70 \text{ N/mm}^2$$

(b) Wall

- (i) Outside confined boundary elements as defined in clause 9.9.3.2.

3.4 PRESTRESSING TENDONS

3.4.1 General

This section applies to wires, bars and strands complying with acceptable standards, and used as prestressing tendons in concrete structures.

3.4.2 Characteristic strength

The characteristic strength of a prestressing tendon, unless stated otherwise, means the ultimate strength below which 5% of all possible test results would be expected to fall.

3.4.3 Ductility

The products shall have adequate ductility in elongation and bending.

3.4.4 Physical properties

The following mean values may be used:

- (a) density 7850 kg/m³; and
- (b) coefficient of thermal expansion 12x10⁻⁶/°C.

3.4.5 Stress-strain relationships for design

The short-term design stress-strain curve for prestressing tendons is given in Figure 3.10 below, with γ_m having the relevant value. For sustained loading, appropriate allowance for relaxation should be made.

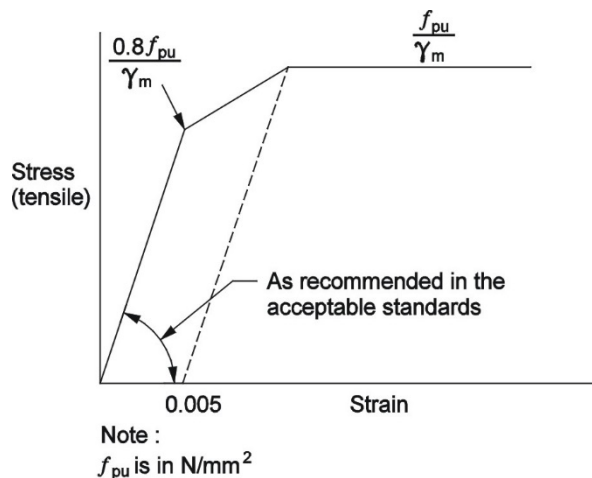

Figure 3.10 - Short-term design stress-strain curve for prestressing tendons

3.5 PRESTRESSING DEVICES

3.5.1 Anchorages and couplers

3.5.1.1 General

This section applies to anchoring devices (anchorages) and coupling devices (couplers) in post tensioned construction.

All anchorages should comply with the acceptable standards.

3.5.1.2 Mechanical properties

Tendon-anchorage assemblies and tendon coupler assemblies shall have strength, elongation and fatigue characteristics sufficient to meet the basic requirements of section 2.

3.6 NEW MATERIALS

3.6.1 General

The requirements of this code of practice are not to be construed as prohibiting the use of new and alternative materials.

3.6.2 Acceptance requirements

The properties of new materials must be adequately demonstrated to comply with the basic requirements of section 2.

For this purpose sufficient information must be provided, including manufacturing data, testing and proposed quality controls, to allow independent third party evaluation of such compliance.

3.7 DESIGN STRENGTH AT ELEVATED TEMPERATURES

Design strength for concrete, reinforcement and prestressing tendon at elevated temperatures may be taken as the normal design strength multiplied by the strength reduction factors given in Table 3.5, Table 3.6 and Table 3.7 for concrete, reinforcement and prestressing tendon respectively.

| Temperature | Strength reduction factors |
|-------------|----------------------------|
| 20 °C | 1.00 |
| 100 °C | 1.00 |
| 200 °C | 0.95 |
| 300 °C | 0.85 |
| 400 °C | 0.75 |
| 500 °C | 0.60 |
| 600 °C | 0.45 |
| 700 °C | 0.30 |
| 800 °C | 0.15 |
| 900 °C | 0.08 |
| 1000 °C | 0.04 |
| 1100 °C | 0.01 |
| 1200 °C | 0.00 |

Table 3.5 - Strength reduction factors for concrete

| Temperature | Strength reduction factors |
|-------------|----------------------------|
| 20 °C | 1.00 |
| 100 °C | 1.00 |
| 200 °C | 1.00 |
| 300 °C | 1.00 |
| 400 °C | 0.87 |
| 500 °C | 0.60 |
| 600 °C | 0.36 |
| 700 °C | 0.11 |
| 800 °C | 0.08 |
| 900 °C | 0.06 |
| 1000 °C | 0.04 |
| 1100 °C | 0.02 |
| 1200 °C | 0.00 |

Table 3.6 - Strength reduction factors for reinforcement

| Temperature | Strength reduction factors | |
|-------------|----------------------------|------|
| | Wires & Strands | Bars |
| 20 °C | 1.00 | 1.00 |
| 100 °C | 1.00 | 1.00 |
| 200 °C | 0.82 | 1.00 |
| 300 °C | 0.64 | 0.78 |
| 400 °C | 0.44 | 0.55 |
| 500 °C | 0.21 | 0.25 |
| 600 °C | 0.09 | 0.09 |
| 700 °C | 0.08 | 0.08 |
| 800 °C | 0.06 | 0.06 |
| 900 °C | 0.05 | 0.05 |
| 1000 °C | 0.03 | 0.03 |
| 1100 °C | 0.02 | 0.02 |
| 1200 °C | 0.00 | 0.00 |

Table 3.7 - Strength reduction factors for prestressing tendon

4 DURABILITY AND FIRE RESISTANCE

4.1 OBJECTIVES

4.1.1 Durability

A durable structure shall meet the requirements of strength and stability throughout its intended design working life without significant loss of utility or excessive unforeseen maintenance. This is dependent upon the integration of every aspect of design, materials and construction. A durable concrete element is one that is designed and constructed to protect embedded metal from corrosion and to perform satisfactorily in the working environment for the design working life of the structure.

The required level of protection of the structure shall be established by taking into consideration the following:

- (a) its intended use;
- (b) design working life;
- (c) maintenance programme; and
- (d) environment.

The guidelines given in the following clauses are based on a design working life of 50 years.

The environmental conditions to which the concrete will be exposed should be defined early in the design stage. The design should take account of the shape and bulk of the structure, and the need to ensure that surfaces exposed to water are freely draining (see clause 4.2.2). Adequate cover to steel has to be provided for protection (see clause 4.2.4). Consideration may also be given to the use of protective coatings to either the steel or the concrete, or both, to enhance the durability of vulnerable parts of the structure.

Concrete should be of the appropriate quality, which depends on both its constituent materials and mix proportions. There is a need to avoid some constituent materials which may cause durability problems and, in other instances where conditions are particularly aggressive, to specify particular types of concrete to meet special durability requirements (see clauses 4.2.5, 4.2.6 and 4.2.7).

Good workmanship, particularly curing, is essential and dimensional tolerances and the levels of control and inspection of construction should be specified. Use should be made of suitable quality assurance schemes where they exist (see sections 10 and 11).

Note: For exceptionally severe environments additional precautions may be necessary and specialist literature should be consulted.

4.1.2 Fire resistance

A structure or structural element required to have fire resistance should be designed to possess an appropriate degree of resistance to the following:

- (a) flame penetration;
- (b) heat transmission; and
- (c) collapse.

Recommendations are given in clause 4.3.

4.2 REQUIREMENTS FOR DURABILITY

4.2.1 General

One of the main characteristics influencing the durability of concrete is its permeability to the ingress of water, oxygen, carbon dioxide and other potentially deleterious substances. Permeability is governed by the constituents and procedures used in making the concrete. With normal-weight aggregates a suitably low permeability is achieved by having an adequate cementitious content, a sufficiently low free water/cement ratio, complete compaction of the concrete, and sufficient hydration of the cement through proper curing.

The factors influencing durability include:

- (a) the shape and bulk of the concrete (clause 4.2.2.1);
- (b) the cover to embedded steel (clauses 4.2.2.2 and 4.2.4);

- (c) the environment (clause 4.2.3);
- (d) the type of cementitious material(s) (clauses 4.2.5 and 4.2.7);
- (e) the type of aggregate (clauses 4.2.5 and 4.2.7);
- (f) the cementitious content and water/cement ratio of the concrete (clause 4.2.6); and
- (g) workmanship, to obtain full compaction and efficient curing (clauses 10.3.5 and 10.3.6).

The degree of exposure anticipated for the concrete during its design working life together with other relevant factors relating to mix composition, workmanship and design should be considered. The concrete mix to provide adequate durability under these conditions should be chosen taking account of the accuracy of current testing regimes for control and compliance as described in this Code of Practice.

4.2.2 Design for durability

4.2.2.1 Shape and bulk of concrete

Since many processes of deterioration of concrete only occur in the presence of free water, the structure should be designed, wherever possible, to minimise uptake of water or exposure to moisture. The shape or design details of exposed structures should be such as to promote good drainage of water and to avoid ponding and rundown of water. Care should also be taken to minimise any cracks that may collect or transmit water.

Concrete is more vulnerable to deterioration due to chemical or climatic attack when it is:

- (a) in thin sections;
- (b) under hydrostatic pressure from one side only;
- (c) partly immersed; or
- (d) at corners and edges of the structural elements.

Good curing (see clause 10.3.6) is essential to avoid the harmful effects of early loss of moisture.

Where the minimum dimension of the concrete to be placed in one continuous operation is greater than 600 mm, and especially where the cementitious content is 400 kg/m³ or more, measures to reduce the temperature such as using material with a slower release of heat of hydration should be considered.

4.2.2.2 Concrete cover and concrete quality.

The protection of the steel in concrete against corrosion depends on the alkaline environment provided by an adequate thickness of good quality concrete.

Clause 4.2.4 gives the limiting values for the nominal cover of normal-weight aggregate concrete which should be provided to all reinforcement, including links, and to prestressing tendons, respectively, depending on the condition of exposure described in clause 4.2.3 and on the characteristics of the concrete mix.

It should be noted that these specified nominal covers are those required for durability and should be checked against the requirements for fire protection (see clause 4.3) and the safe transfer of bond forces (see clause 8.7).

4.2.3 Exposure conditions

4.2.3.1 General environment

The general environment to which the concrete will be exposed during its working life is classified into four levels of severity, from 1 to 4, with condition 4 being the most severe. Condition 5 refers to the particular case of concrete surfaces subject to abrasive action through use rather than to an environmental exposure condition. The recommendations for the cover to steel and for concrete quality for reinforced concrete and for prestressed concrete subjected to these exposure conditions are given in clause 4.2.4. The recommendations for concrete not containing embedded metal are given in clause 4.2.6.2.

4.2.3.2 Classification of exposure conditions

The exposure conditions listed in Table 4.2 are described in Table 4.1.

| Exposure condition | Type of exposure |
|--|--|
| 1 | <p>Mild</p> <p>Internal concrete surfaces.</p> <p>External concrete surfaces protected from the effects of severe rain or cyclic wetting and drying e.g. concrete finish with mosaic tiles, painting or rendering.</p> <p>Concrete surfaces continuously under water, or rarely dry - not sea water.</p> <p>Concrete in contact with non-aggressive soil.</p> |
| 2 | <p>Moderate</p> <p>Internal concrete surfaces exposed to high humidity e.g. bathrooms and kitchens.</p> <p>External concrete surfaces exposed to the effects of severe rain or cyclic wetting and drying e.g. fair faced concrete, concrete with cladding secured by dry or mechanical fixing, curtain walling.</p> |
| 3 | <p>Severe</p> <p>Concrete surfaces exposed to sea water spray through airborne contact but not direct exposure, i.e. structures on or near the coast.</p> <p>Concrete surfaces exposed to corrosive fumes.</p> |
| 4 | <p>Very Severe</p> <p>Concrete surfaces frequently exposed to sea or flowing water with pH \leq 4.5.</p> <p>Concrete in sea water tidal zone down to 1 m below lowest low water level.</p> |
| 5 | <p>Abrasive</p> <p>Concrete surfaces exposed to abrasive action machinery, metal tyred vehicles or water carrying solids.</p> |
| <p>Note:</p> <p>1. Cement bedding for finishes should be ignored in exposure considerations.</p> | |

Table 4.1 - Exposure conditions

4.2.3.3 Exposure to aggressive chemicals

Deterioration of concrete by chemical attack can occur by contact with gases or solutions of many chemicals, but is generally the result of exposure to acidic solution or to solutions of sulphate salts. Where this is believed to be a potential problem, reference should be made to specialist literature.

4.2.4 Cover

4.2.4.1 Nominal Cover

(a) General

Nominal cover is the design depth of concrete cover to all reinforcement, including links. It is the dimension used in design and indicated on the drawings. The actual cover to all reinforcement should not be less than the nominal cover minus 5 mm. The nominal cover should:

- (i) comply with the recommendations for bar diameter, aggregate size and for concrete cast against uneven surfaces (clauses 4.2.4.1 (b) to (d));
- (ii) protect the steel against corrosion (clause 4.2.4.3);
- (iii) protect the steel against fire (clause 4.3);
- (iv) provide sufficient depth of concrete for safe transmission of bond forces (see clause 8.7); and
- (v) allow for surface treatments such as bush hammering.

(b) Bar diameter

The nominal cover to all steel should be such that the resulting cover to a main bar should not be less than the diameter of the main bar or, where bars are in pairs or bundles, the diameter of a single bar of cross-sectional area equal to the sum of their cross-sectional areas. At the same time the nominal cover to any links should be preserved.

(c) Nominal maximum size of aggregate

Nominal cover should be not less than the nominal maximum size of the aggregate.

(d) Concrete cast against uneven surfaces

In such cases the specified nominal cover should generally be increased beyond the values given in clause 4.2.4.4 to ensure that an adequate minimum cover will be obtained. For this reason, the nominal cover specified where concrete is cast directly against the earth should generally be not less than 75 mm. Where concrete is cast against an adequate blinding, a nominal cover of not less than 40 mm (excluding blinding) should generally be specified.

4.2.4.2 *Ends of straight bars*

Cover is not required to the end of a straight bar in a floor or roof unit where its end is not exposed to the weather or to condensation.

4.2.4.3 *Cover against corrosion*

The cover required to protect the reinforcement against corrosion depends on the exposure conditions and the quality of the concrete as placed and cured immediately surrounding reinforcement. Table 4.2 gives limiting values for the nominal cover of concrete made with normal-weight aggregates as a function of these factors. There may be cases where extra precautions are needed beyond the requirements given in clause 4.2.4.4 in order to achieve adequate protection of the reinforcement. Further information is given in clause 4.2.2.

4.2.4.4 *Limiting values for nominal cover*

For reinforced concrete, the nominal cover required to all reinforcement for durability should be as specified in Table 4.2. The nominal cover should also be applied to mechanical couplers, if used, unless the mechanical couplers are made from materials with enhanced corrosion resistance.

| Conditions of exposure (see clause 4.2.3) | Nominal cover (mm) | | | | | | |
|---|-----------------------|------|------|------|------|------|------|
| | C20/25 | C30 | C35 | C40 | C45 | C50 | ≥C55 |
| Lowest grade of concrete | C20/25 | C30 | C35 | C40 | C45 | C50 | ≥C55 |
| Condition 1 | | | | | | | |
| - slabs only | 30 | 30 | 25 | 25 | 25 | 25 | 25 |
| - other members | 35 | 30 | 30 | 30 | 25 | 25 | 25 |
| Condition 2 | -- | 40 | 35 | 35 | 30 | 30 | 30 |
| Condition 3 | -- | -- | -- | 50 | 45 | 45 | 45 |
| Condition 4 | -- | -- | -- | -- | -- | 55 | 50 |
| Condition 5 (see note 3) | -- | -- | -- | -- | -- | -- | -- |
| Maximum free water/cement ratio | 0.65 | 0.65 | 0.60 | 0.55 | 0.45 | 0.40 | 0.35 |
| Minimum cementitious content (kg/m ³) | 290 | 310 | 330 | 350 | 375 | 400 | 400 |
| Notes: | | | | | | | |
| 1. This table relates to normal-weight aggregate of 20 mm nominal size. Adjustments to minimum cementitious contents for aggregates of nominal sizes other than 20 are given in clause 4.2.5.4. | | | | | | | |
| 2. Cover not less than the nominal cover corresponding to the environmental exposure condition plus any allowance for loss of cover due to abrasion. | | | | | | | |
| 3. Consideration should also be given to cover requirements for fire protection (see clause 4.3) and the safe transmission of bond forces (see clause 8.7). | | | | | | | |
| 4. For prestressed concrete, grade C30 or lower should not be used and the minimum cement cementitious should be 300 kg/m ³ . | | | | | | | |

Table 4.2 - Nominal cover to all reinforcement (including links) and minimum concrete grade to meet durability requirements for reinforced and prestressed concrete

4.2.4.5 *Control of cover*

Good workmanship is required to ensure that the reinforcement is properly placed and that the specified cover is obtained. Recommendations for this are given in clause 10.4.3.

4.2.5 **Concrete materials and mixes**

4.2.5.1 *Mix proportions*

Table 4.2 gives maximum free water/cement ratios and minimum cementitious contents for concrete appropriate for use in given environments with specified covers for both reinforced and prestressed concrete. The minimum grades will generally ensure that the limits on free water/cement ratio and cementitious content will be met without further checking. These limits relate to concrete made using 20 mm nominal maximum sized normal-weight aggregates.

4.2.5.2 *Permitted reduction in concrete grade*

Where due to the nature of the constituent materials there is difficulty in complying with the concrete grades in Table 4.2, the further checking not required in clause 4.2.5.1 becomes necessary to ensure compliance with the limits on the free water/cement ratio and cementitious content. Provided a systematic checking regime is established to ensure compliance with these limits in the concrete as placed, the concrete grades specified may be relaxed by not more than 5. This relaxation should not be applied to the mixes permitted in clause 4.2.5.5.

4.2.5.3 *Permitted reduction in cementitious content*

Where concrete with free water/cement ratios significantly lower than the maximum values in Table 4.2, which are appropriate for nominal workability, is both manufactured and used under specially tightly controlled conditions, the cementitious content may be reduced provided the following requirements are met:

- (a) the reduction in cementitious content does not exceed 10% of the appropriate value in Table 4.2;
- (b) the corresponding free water/cement ratio is reduced by not less than the percentage reduction in the cementitious content;
- (c) the resulting mix can be placed and compacted properly; and
- (d) systematic controls are established to ensure that the reduced limits are met in the concrete as placed.

4.2.5.4 *Adjustment to cementitious contents for different sized aggregates*

The minimum cementitious contents given in Tables 4.2 relate to 20 mm nominal maximum size of aggregate. For other sizes of aggregate they should be modified as given in Table 4.3 subject to the condition that the cementitious content should be not less than 240 kg/m³ for the exposure conditions covered by Table 4.2.

| Nominal maximum aggregate size (mm) | Adjustment to minimum cementitious contents (kg/m ³) |
|--|--|
| 10 | +40 |
| 14 | +20 |
| 20 | 0 |
| 40 | -30 |

Table 4.3 - Adjustments to minimum cementitious contents for aggregates other than 20 mm nominal maximum size

4.2.5.5 *Use of pulverised-fuel ash (pfa) and ground granulated blastfurnace slag (ggbs)*

Where required, either pfa or ggbs should be exclusively combined with Portland cement. If blended cement with pfa or ggbs is used instead of Portland cement, further pfa or ggbs should not be added as a cement replacement. The concrete mix recommendations given in table 4.2 apply also when combinations of Portland cement with pfa or ggbs are used.

The usual range of pfa or ggbs content by mass of the total cementitious content should be:

- (a) 25% to 35% for pfa

(b) 35% to 75% for ggbs.

A higher percentage may be used in special applications but will require expert advice and stringent site control.

The durability of the concrete made with these materials can be considered as being equal to that of Portland cement concrete, provided that the pfa or ggbs concrete complies with the same grade as would be achieved by the Portland cement concrete. In order to achieve concrete of equal strength at 28 days, depending on the combination used, it may be necessary to increase the total mass of Portland cement plus pfa or ggbs when compared with the total mass of Portland cement in the concrete for a Portland cement mix.

Durability is related to impermeability as well as strength and hence curing is particularly important. More critical attention to a prolonged curing period of concrete is required with mixes containing pfa or ggbs. The specification for materials, curing and removal of formwork should be carefully considered, taking into account the possible reduction in early strength of the concrete. A quality assurance proposal with sufficient preliminary test results should be established to ensure that a reliable and consistent concrete production can be achieved. This should include a detailed assessment of the concreting materials, the mix design, the quality control procedures of the batching plant and the necessary trial mix production.

4.2.6 Mix proportions

4.2.6.1 General

The free water/cement ratio is an important factor in the durability of concrete and should always be the lowest value compatible with producing fully compacted concrete without segregation or bleeding. Appropriate values for the maximum free water/cement ratio are given in Tables 4.2 and 4.4 for particular exposure conditions.

A minimum cementitious content is required to ensure a long service life under particular exposure conditions, and appropriate values are given in Tables 4.2 and 4.4. However, the cementitious content required for a particular water/cement ratio can vary significantly for different mix constituents. Where adequate workability is difficult to obtain at the maximum free water/cement ratio allowed, an increased cementitious content, the use of pfa or ggbs, and/or the use of plasticisers or water-reducing admixtures should be considered.

For normal strength concrete, i.e. $f_{\text{CU}} \leq 60 \text{ N/mm}^2$, a total cementitious content including cement, silica fume and pfa or ggbs in excess of 550 kg/m^3 should not be used unless special consideration has been given in design to the increased risk of cracking due to drying shrinkage in thin sections or to thermal stresses in thicker sections. For high strength concrete ($f_{\text{CU}} > 60 \text{ N/mm}^2$), total cementitious contents should be controlled to avoid large heat of hydration as well as large shrinkage and creep strains. Under normal circumstances, the mass of cement of the cementitious content should be limited to not more than 450 kg/m^3 .

For concrete made with normal-weight aggregate and used in foundations to low rises structures in non-aggressive soil conditions, a minimum grade of C20 may be used provided the minimum cementitious content is not less than 290 kg/m^3 .

For high strength concrete, reference should also be made to requirements in clause 4.3.

4.2.6.2 Unreinforced concrete

Table 4.4 gives recommended values for the maximum free water/cement ratio, the minimum cementitious content and the lowest grade of concrete to ensure long service life under the appropriate conditions of exposure.

| Condition of exposure (see clause 4.2.3.2) | Concrete not containing embedded metal | | |
|---|--|---|--------------------------|
| | Maximum free water/cement ratio | Minimum cementitious content (kg/m ³) | Lowest grade of concrete |
| 1 | 0.65 | 290 | C20 |
| 2 | 0.65 | 290 | C30 |
| 3 | 0.55 | 325 | C35 |
| 4 | 0.50 | 350 | C45 |
| 5 | 0.50 | 350 | C50 |

Notes:

1. See clause 4.2.6.3 for adjustments to the mix proportions.
2. See clause 4.2.5.2 for permitted reduction in concrete grade.
3. See clause 4.2.6.1 for concrete used in foundations to low rise structures in non-aggressive soil conditions.

Table 4.4 - Durability of unreinforced concrete made with normal-weight aggregates of 20 mm nominal maximum size

When a member is designed as unreinforced but contains reinforcing bars, the member may be treated as unreinforced for the purposes of this clause provided that any damage to the cover concrete or unsightliness that may result from corrosion of the bars is acceptable.

4.2.6.3 *Mix adjustments*

The cementitious contents given in Table 4.4 apply to 20 mm nominal maximum size aggregate. For other sizes of aggregate they should be changed as given in Table 4.3.

Different aggregates require different water contents to produce concrete of the same workability and therefore at a given cementitious content, different water/cement ratios are obtained. In order to achieve a satisfactory workability at the specified maximum free water/cement ratio, it may be necessary to modify the mix as described in clause 4.2.6.1.

4.2.7 **Mix constituents**

4.2.7.1 *General*

Aggregates should have a low drying shrinkage. Marine aggregates and some inland aggregates contain chlorides and require careful selection and efficient washing to achieve the chloride ion limit for concrete given in Table 4.5. Consideration may have to be given to other impurities where considered significant.

Air-entraining admixtures and plasticising admixtures can improve the handling and placing of fresh concrete. Limits on the chloride content of admixtures when used in concrete containing embedded metal are given in Table 4.5.

4.2.7.2 *Chlorides in concrete*

Whenever there is chloride in concrete there is an increased risk of corrosion of embedded metal. The higher the chloride content is, the higher is the curing temperature, or if subsequently exposed to warm moist conditions, the greater is the risk of corrosion. Chloride may also adversely affect the sulphate resistance of concrete.

All constituents may contain chlorides and concrete may be contaminated by chlorides from air-borne salt spray or the sea. Calcium chloride and chloride-based admixtures should never be added in reinforced concrete, prestressed concrete and concrete containing embedded metal.

It is recommended that the total chloride content of the concrete mix arising from the aggregate together with that from any admixtures and any other source should not exceed the limits, expressed as a percentage relationship between chloride ion and mass of cement in the mix, given in Table 4.5.

Wherever possible, the total chloride content should be calculated from the mix proportions and the measured chloride contents of each of the constituents.

| Type or use of concrete | Maximum total chloride content expressed as a percentage of chloride ion by mass of cement ⁽¹⁾ |
|---|---|
| Prestressed concrete. Steam-cured structural concrete | 0.1 |
| Concrete made with Sulphate Resisting Portland cement | 0.2 |
| Concrete with reinforcement or other embedded metal | 0.35 |
| Note: 1. Inclusive of pfa or ggbs | |

Table 4.5 - Limits of Chloride content of concrete

4.2.7.3 Alkali-aggregate reaction

Aggregates containing silica minerals or argillaceous dolomitic limestone are susceptible to attack by alkalis (Na₂O and K₂O) from the cement or other sources. Alkali aggregate reaction may cause cracking and may reduce the strength of concrete.

Effective means of reducing the risk of alkali aggregate reaction include:

- (a) control on the amount of cement used in the concrete mix;
- (b) use of a low alkali cement;
- (c) use of an appropriate cement replacement such as pfa or ggbs;
- (d) the reactive alkali content of concrete expressed as the equivalent sodium oxide per cubic metre should not exceed 3.0 kg;
- (e) expert advice should be sought when alkali reactive aggregates are used;
- (f) use of non-reactive aggregate (in accordance with CS1); or
- (g) reduce the access of moisture, i.e. restrict the amount of water ingress from the environment.

The concrete supplier should submit a mix design and Hong Kong Laboratory Accreditation Scheme (HOKLAS) endorsed test certificates giving calculations and test results demonstrating that the mix complies with the above limitation on reactive alkali content.

Argillaceous dolomitic limestone aggregates which could be susceptible to alkali-carbonate reaction should not be used.

4.2.7.4 Placing, compacting, finishing and curing

A high degree of compaction without segregation should be ensured by providing suitable workability and by employing appropriate placing and compacting equipment and procedures (see clause 10.3.5). Full compaction is particularly important in the vicinity of construction and movement joints and of embedded water bars and reinforcement.

Good finishing practices are essential for durable concrete (see clause 10.3.9). Overworking the surface and the addition of water to aid in finishing should be avoided; the resulting laitance will have impaired strength and durability.

It is essential to use proper and adequate curing techniques to reduce the permeability of the concrete and enhance its durability by extending the hydration of the cement, particularly in its surface zone (see clause 10.3.6).

4.3 REQUIREMENTS FOR FIRE RESISTANCE

In some circumstances, the cover specified for durability will not be sufficient for fire protection. Where applicable, the nominal cover should be modified in accordance with the guidelines given in the Code of Practice for Fire Safety in Buildings which also specifies minimum dimensions of members for specified periods of fire resistance.

For concrete compressive strength greater than 60 MPa, the possible reduction of strength at elevated temperatures and the associated risk of spalling should be investigated, taken into account the

relevant factors including moisture content, type of aggregate, permeability of concrete, possible heating rate and the silica fume content.

4.3.1 Prevention of spalling in high strength concrete

4.3.1.1 General requirement

For high strength concrete, the reduction of strength and associated risk of spalling at elevated temperature shall be taken into account. The content of silica fume if used in high strength concrete should not exceed 6% by weight of the total cementitious content. Pfa and ggbs if used in high strength concrete should comply with the requirements given in clause 4.2.5.5; there is no additional requirement or restriction on the use of pfa or ggbs as they are conducive to the prevention of spalling in high strength concrete.

4.3.1.2 Methods to reduce risk of concrete spalling

At least one of the following methods should be provided.

- (a) **Method A:** A reinforcement mesh with a nominal cover of 15 mm. This mesh shall have wires with a diameter ≥ 2 mm with a pitch $\leq 50 \times 50$ mm. The nominal cover to the main reinforcement shall be ≥ 40 mm; or
- (b) **Method B:** Include in the concrete mix not less than 1.5 kg/m^3 of monofilament propylene fibres. The fibres shall be 6 – 12 mm long and 18 – 32 μm in diameter, and shall have a melting point less than 180°C ; or
- (c) **Method C:** Protective layers for which it is demonstrated by local experience or fire testing that no spalling of concrete occurs under fire exposure; or
- (d) **Method D:** A design concrete mix for which it has been demonstrated by local experience or fire testing that no spalling of concrete occurs under fire exposure.

Note: Post-fire investigation should include an assessment on the type and extent of remedial works that are required to restore the effectiveness of the adopted method for reducing the risk of concrete spalling.

For high strength concrete exceeding C80, at least one fire test should be carried out to demonstrate that the main reinforcing bars of a structural member shall not be exposed during the design fire resistance rating. The test specimen should have moisture content not less than the highest moisture content that the structure may attain during its working life.

5 STRUCTURAL ANALYSIS

5.1 GENERAL PROVISIONS

5.1.1 General provisions

In the analysis of the structure, or part of the structure, to determine force distributions within the structure, the properties of materials may be assumed to be those associated with their characteristic strengths, irrespective of which limit state is being considered. In the analysis of any cross section within the structure, the properties of the materials should be assumed to be those associated with their design strengths appropriate to the limit state being considered.

The methods of analysis used should be based on as accurate a representation of the behaviour of the structure as is reasonably practicable. The methods and assumptions given in this clause are generally adequate but, in certain cases, more fundamental approaches in assessing the behaviour of the structure under load may be more appropriate.

The analysis of the structure at all stages, including each stage of construction, shall take into account the appropriate structural framing, geometry and properties at each stage.

5.1.2 Methods of analysis

The primary objective of structural analysis is to obtain a set of internal forces and moments throughout the structure that are in equilibrium with the design loads for the required loading combinations.

Under design ultimate loads, any implied redistribution of forces and moments should be compatible with the ductility of the members concerned. Generally it will be satisfactory to determine envelopes of forces and moments by linear elastic analysis of all or parts of the structure and allow for redistribution and possible buckling effects using the methods described in section 5. Alternatively plastic methods, e.g. yield line analysis, may be used.

For design service loads, the analysis by linear elastic methods will normally give a satisfactory set of moments and forces. When linear elastic analysis is used, the relative stiffness of members may be based on any of the following:

- (a) the concrete section: the entire concrete cross section, ignoring the reinforcement;
- (b) the gross section: the entire concrete cross section, including the reinforcement on the basis of modular ratio; or
- (c) the transformed section: the compression area of the concrete cross section combined with the reinforcement on the basis of modular ratio.

A consistent approach should be used for all elements of the structure.

5.1.3 Load cases and combinations

5.1.3.1 General

In considering the combinations of loadings, the appropriate load combinations shall be considered to enable the critical design conditions to be established at all critical sections within the structure or section of the structure under consideration.

5.1.3.2 Beams and Slabs

In buildings, for continuous beams and slabs without cantilevers, which are subjected to predominantly uniform distributed loads, simplified combinations of load cases may be used. In general, the following simplified load cases may be considered:

- (a) all spans loaded with the maximum design load ($\gamma_f G_k + \gamma_f Q_k$);
- (b) alternate spans loaded with the maximum design load ($\gamma_f G_k + \gamma_f Q_k$) and all other spans loaded with the minimum design load ($\gamma_f G_k$); or
- (c) any two adjacent spans loaded with the maximum design load ($\gamma_f G_k + \gamma_f Q_k$), and all other spans loaded with the minimum design load, ($\gamma_f G_k$).

For all of the above cases, the appropriate value of γ_f for adverse and beneficial conditions as specified in clauses 2.3.2 and 2.3.3 should be taken.

5.1.3.3 Columns and walls

For columns and walls, the load cases considered should be those necessary to give the critical bending moments and shears for the following cases:

- (a) maximum axial load combined with coexistent bending moment;
- (b) minimum axial load combined with coexistent bending moment;
- (c) maximum bending moment combined with coexistent axial load; and
- (d) any other coexistent combination of axial load and bending moment which will be more critical to the column design than the above cases.

In most cases, the loading configurations identified in clause 5.1.3.2 combined where necessary with any applied lateral loads will be sufficient.

5.1.4 Imperfections and second order effects

The adverse effects of possible deviations in the geometry of the loaded structure shall be taken into account in the ultimate limit states and accidental situations. It is not normally necessary to consider them at serviceability limit states.

Second order effects shall be taken into account where they are likely to significantly affect the overall stability of a structure or the attainment of ultimate limit state at critical sections.

5.2 ANALYSIS OF STRUCTURE

5.2.1 Idealisation of the structure

5.2.1.1 Structural models for overall analysis

The elements of a structure are classified, by consideration of their nature and function, as beams, columns, slabs, walls, plates, arches, shells etc. Rules are provided for the analysis of these elements and of the structures consisting of combinations of these elements.

For buildings the following provisions are applicable:

- (a) A beam is a member for which the span is not less than 2 times the overall section depth for simply supported spans and 2.5 times the overall depth for continuous spans. Otherwise it should be considered as a deep beam.
- (b) A slab is a member for which the minimum panel dimension is not less than 5 times the overall slab thickness.
- (c) A slab subjected to dominantly uniformly distributed loads may be considered to be one way spanning either:
 - (i) it possesses two free (unsupported) and parallel edges; or
 - (ii) it is the central part of a rectangular slab supported on four edges with a ratio of the longer to shorter span greater than 2.
- (d) Ribbed or waffle slabs need not be treated as discrete elements for the purposes of analysis, provided that the flange or structural topping and transverse ribs have sufficient torsional stiffness. This may be assumed provided that:
 - (i) the rib spacing does not exceed 1500 mm and the depth of the rib below the flange does not exceed 4 times its width;
 - (ii) the depth of the flange is at least 1/10 of the clear distance between ribs or 50 mm, whichever is the greater; and
 - (iii) transverse ribs are provided at a clear spacing not exceeding 10 times the overall depth of the slab.

The minimum flange thickness of 50 mm may be reduced to 40 mm where permanent blocks are incorporated between the ribs.

- (e) A column is a member for which the section depth does not exceed 4 times its width. Otherwise it should be considered as a wall.

5.2.1.2 Geometrical data

(a) Effective width of flanges (all limit states)

In T beams the effective flange width, over which uniform conditions of stress can be assumed, depends on the web and flange dimensions, the type of loading, the span, the support conditions and the transverse reinforcement.

The effective width of flange should be based on the distance l_{pi} between points of zero moment, which may be obtained from Figure 5.1.

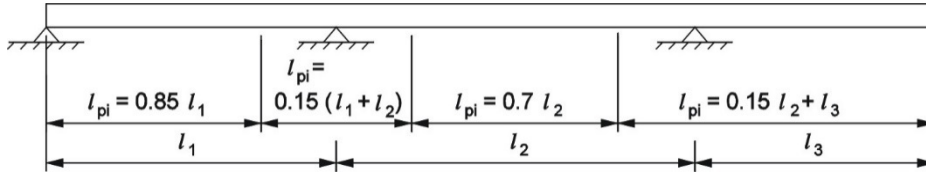

Figure 5.1 - Definition of l_{pi} for calculation of flange width

Note: The length of the cantilever, l_3 , should be less than half the adjacent span. The ratio of adjacent spans should lie between 2/3 and 1.5.

The effective flange width b_{eff} for a T beam or L beam may be taken as:

$$b_{eff} = \sum b_{eff,i} + b_w \quad 5.1$$

with $i = 1$ or 2 , and

$$b_{eff,i} = 0.2b_f + 0.1l_{pi} \leq 0.2l_{pi} \quad (\text{See Note 1}) \quad 5.2$$

and

$$b_{eff,i} \leq b_f \quad 5.3$$

Note 1:

(a) Unless $b_{eff,i}$ is taken as $\leq 0.1l_{pi}$, the shear stress between the web and flange should be checked and provided with transverse reinforcement.

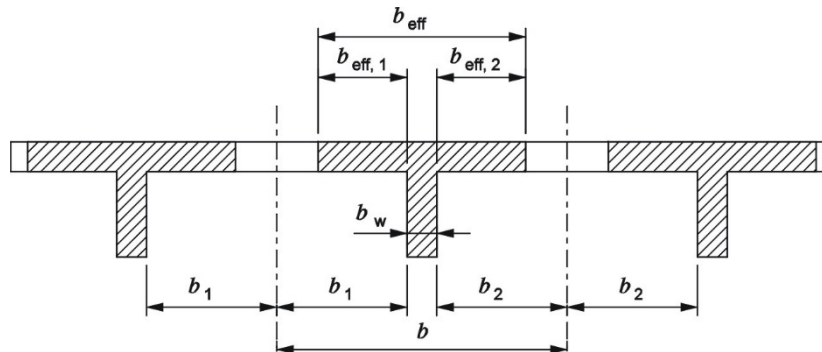

Figure 5.2a - Effective flange width parameters

(b) The longitudinal shear stress, v_{sf} , at the interface between one side of a flange and the web, should be taken as:

$$v_{sf} = \Delta F_d / (h_f \Delta_x) \quad 5.3a$$

where:

h_f is the thickness of the beam flange

Δ_x is the longitudinal length of the flange beam under consideration (see Figure 5.2b) of which the maximum value may be assumed to be half the distance between the section where the moment is 0 and the section where the moment is maximum. Where point loads are applied, this length should not exceed the distance between the point loads

ΔF_d is the change of compressive force in the flange over the length Δ_x

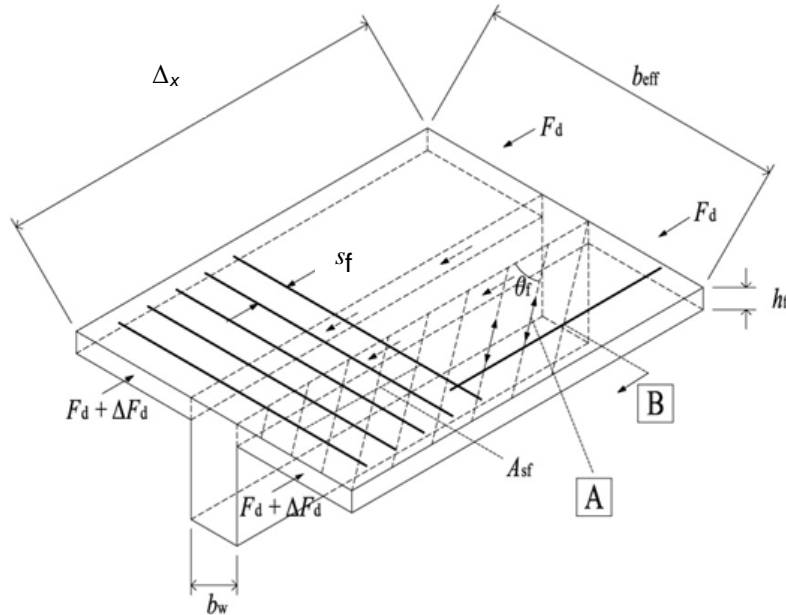

A - compressive struts

B - longitudinal bar anchored beyond this projected point (see Note 1(e))

Figure 5.2b - Notations for the connection between flange and web

(c) Transverse reinforcements per unit length A_{sf}/s_f should be determined by assuming the flange to behave as a braced framework consisting of concrete struts and ties formed by tensile reinforcements and using the following equation:

$$0.87f_y A_{sf}/s_f \geq v_{sf} h_f / \cot \theta_f \quad 5.3b$$

where:

A_{sf} is the area of flange transverse reinforcement

s_f is the spacing of the flange transverse reinforcement

For the purpose of avoiding failure of the compression struts in the flange, the following condition should be satisfied:

$$v_{sf} \leq (0.68f_{cu}/\gamma_m) \sin \theta_f \cos \theta_f \quad 5.3c$$

In the absence of more rigorous calculation, the following recommended values for $\cot \theta_f$ can be used:

$1.0 \leq \cot \theta_f \leq 2.0$ for compression flanges ($45^\circ \geq \theta_f \geq 26.5^\circ$)

$1.0 \leq \cot \theta_f \leq 1.25$ for tension flanges ($45^\circ \geq \theta_f \geq 38.6^\circ$)

(d) In case of combined shear between the flange and the web, and transverse bending, the area of steel should be the greater of that determined by Equation 5.3b or half that determined by Equation 5.3b plus that required for transverse bending.

(e) Minimum longitudinal flange reinforcement should be provided in accordance with clause 9.3.1. Longitudinal tension reinforcement in the flange should be anchored beyond the strut required to transmit the force back to the web at the section where this reinforcement is required (see Figure 5.2b).

(f) For structural analysis, where a great accuracy is not required, a constant width may be assumed over the whole span. The value applicable to the span section should be adopted.

(b) Effective span of beams and slabs in buildings

Note: The following provisions are provided mainly for member analysis. For frame analysis some of these simplifications may be used where appropriate.

The effective span, l of a member should be calculated as follows:

$$l = l_n + a_1 + a_2 \quad 5.4$$

where:

l_n is the clear distance between the faces of the supports,

values for a_1 and a_2 , at each end of the span, may be determined from the appropriate a_i values in Figure 5.3 where S_w is the width of the supporting element as shown.

Continuous slabs and beams may generally be analysed on the assumption that the supports provide no rotational restraint.

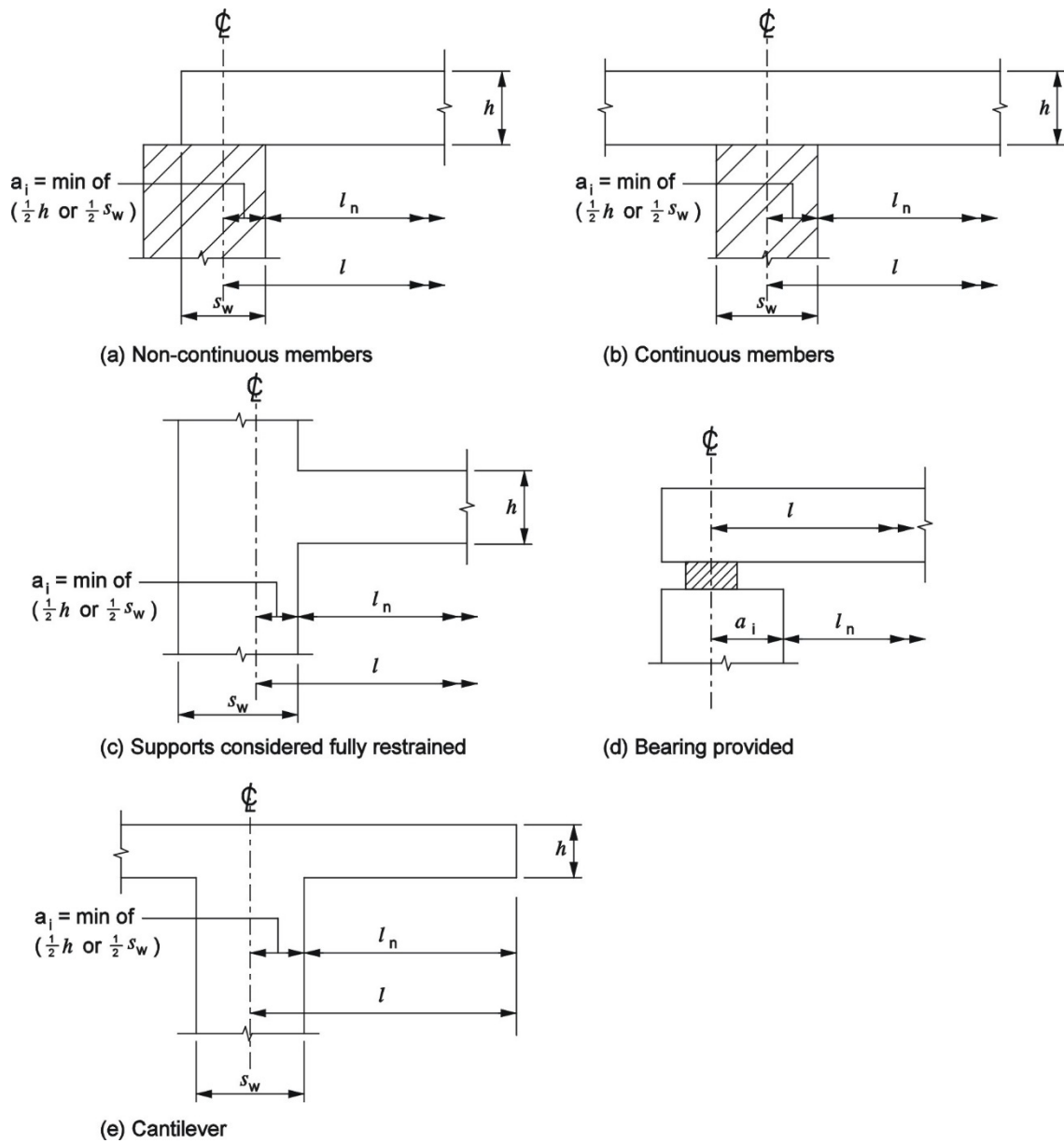

Figure 5.3 - Effective span (l) for different support conditions

Where a beam or slab is monolithic with its supports to provide rotational constraint, the critical design moment at the support should be taken as that at the face of a rectangular support, or at 0.2ϕ inside the face of a circular support of diameter ϕ . The design moment and reaction transferred to the supporting element (e.g. column, wall, etc.) should be taken as the greater of the elastic or redistributed values.

Note: The critical design moment at the support should not be less than 0.65 that of the full fixed end moment.

Regardless of the method of analysis used, where a beam or slab is continuous over a support which may be considered to provide no restraint to rotation (e.g. over walls), the design support moment, calculated on the basis of a span equal to the centre-to-centre distance between supports, may be reduced by an amount ΔM_{Ed} as follows:

$$\Delta M_{Ed} = F_{Ed,sup} S_w / 8 \quad 5.5$$

where:

$F_{Ed,sup}$ is the design support reaction,

S_w is the breadth of the support (see Figure 5.3 b)

5.2.2 Analysis of sections for Ultimate Limit States

The behaviour of a section at a ULS may be assessed assuming plane sections remain plane and linear stress/strain relationships for both steel and concrete.

The strength of a cross-section at the ULS under both short and long term loading may be assessed assuming the short term stress/strain curves derived from the design strengths of the materials as given in section 3 as appropriate. In the case of prestressing tendons, see Figure 3.10.

5.2.3 Analysis of sections for Serviceability Limit States

The behaviour of a section at SLS may be assessed assuming plane sections remain plane and linear stress/strain relationships for both steel and concrete.

Allowance should be made where appropriate for the effects of creep, shrinkage, cracking and prestress losses.

The elastic modulus for steel should be taken as 200 kN/mm². Information on the selection of elastic moduli for concrete may be found in clause 3.1.

5.2.4 Simplifications

Where appropriate the simplifications of analysis outlined in clauses 5.2.5 and 5.2.6 may be adopted.

5.2.5 Monolithic frames not providing lateral restraint

5.2.5.1 Simplification into sub-frames

The moments, loads and shear forces to be used in the design of individual columns and beams of a frame supporting vertical loads only may be derived from an elastic analysis of a series of sub-frames (but see clause 5.2.9 concerning redistribution of moments). Each sub-frame may be taken to consist of the beams at one level together with the columns above and below. The ends of the columns remote from the beams may generally be assumed to be fixed unless the assumption of a pinned end is clearly more reasonable (for example, where a foundation detail is considered unable to develop moment restraint).

5.2.5.2 Choice of critical loading arrangements

It will normally be sufficient to consider the following arrangements of vertical load:

- all spans loaded with the maximum design ultimate load ($1.4G_k + 1.6Q_k$);
- alternate spans loaded with the maximum design ultimate load ($1.4G_k + 1.6Q_k$) and all other spans loaded with the minimum design ultimate load ($1.0G_k$); or
- any two adjacent spans loaded with the maximum design ultimate load ($1.4G_k + 1.6Q_k$), and all other spans loaded with the minimum design ultimate load, ($1.0G_k$).

5.2.5.3 *Alternative simplification for individual beams (and associated columns).*

As an alternative to clause 5.2.5.1, the moments and forces in each individual beam may be found by considering a simplified sub-frame consisting only of that beam, the columns attached to the ends of the beam and the beams on either side, if any. The column and beam ends remote from the beam under consideration may generally be assumed to be fixed unless the assumption of pinned ends is clearly more reasonable. The stiffness of the beams on either side of the beam considered should be taken as half their actual values if they are taken to be fixed at their outer ends. The critical loading arrangements should be in accordance with clause 5.2.5.2.

The moments in an individual column may also be found from this simplified sub-frame provided that the sub-frame has as its central beam the longer of the two spans framing into the column under consideration.

5.2.5.4 *'Continuous' beam simplification*

As a more conservative alternative to the preceding sub-frame arrangements the moments and shear forces in the beams at one level may also be obtained by considering the beams as a continuous beam over supports providing no restraint to rotation. The critical loading arrangements should be in accordance with clause 5.2.5.2.

5.2.5.5 *Asymmetrically-loaded columns*

Where a beam has been analysed in accordance with clause 5.2.5.4, the ultimate moments in the columns may be calculated by simple moment distribution procedures, on the assumption that the column and beam ends remote from the junction under consideration are fixed and that the beams possess half their actual stiffness. The arrangement of the design ultimate imposed load should be such as to cause the maximum moment in the column.

5.2.6 **Frames providing lateral stability**

5.2.6.1 *General*

Where the frame provides lateral stability to the structure as a whole, sway should be considered.

In addition, if the columns are slender, additional moments (e.g. from eccentricity) may be imposed on beams at beam-column junctions (see clause 6.2). The load combinations 2 and 3 (see Table 2.1) should be considered in addition to load combination 1.

5.2.6.2 *Sway-frame of three or more approximately equal bays*

The design of individual beams and columns may be based on either the moments, loads and shears obtained by considering vertical loads only, as in clause 5.2.5.2 or, if more severe, on the sum of those obtained from the following:

- (a) an elastic analysis of a series of sub-frames each consisting of the beams at one level together with the columns above and below assumed to be fixed at their ends remote from those beams (or pinned if this is more realistic). Lateral loads should be ignored and all beams should be considered to be loaded with their full design load ($1.2G_k + 1.2Q_k$); and
- (b) an elastic analysis of the complete frame, assuming points of contraflexure at the centres of all beams and columns, ignoring dead and imposed loads and considering only the design wind load ($1.2W_k$) on the structure. If more realistic, instead of assuming points of contraflexure at the centres of ground floor columns, the lower ends of the columns should be considered pinned.

It will also be necessary to consider the effects of load combination 2 (see Table 2.1), i.e.

$$1.0 G_k + 1.4 W_k.$$

5.2.7 **Slabs**

Guidance on the distribution of design moments and forces in slabs can be found in clause 6.1.3.

5.2.8 **Corbels and nibs**

Simplified rules for the design of corbels and nibs are given in clause 6.5.

5.2.9 Redistribution of moments

5.2.9.1 General

For concrete of strength grade not exceeding C70, redistribution of the moments obtained by means of a rigorous elastic analysis or by the simplified methods of clauses 5.2.5 and 5.2.6 may be carried out provided the following conditions are satisfied:

- (a) Condition 1. Equilibrium between internal and external forces is maintained under all appropriate combinations of design ultimate load;
- (b) Condition 2. Where the design ultimate resistance moment of the cross section subjected to the largest moment within each region of hogging or sagging is reduced, the neutral axis depth x should be checked to see that it is not greater than the value specified in equation 6.4, 6.5 or 6.6 as appropriate (see clause 6.1.2.4 (b)).
- (c) Condition 3. Resistance moment at any section should be at least 70% of moment at that section obtained from an elastic maximum moments diagram covering all appropriate combinations of design ultimate load (but see clause 5.2.9.2 for tall structures).

Note: Unless the column axial load is small, condition 2 will generally rule out reduction in column moment.

5.2.9.2 Restriction to redistribution of moments in structures over four storeys where structural frame provides lateral stability.

The provisions of clause 5.2.9.1 apply except that redistribution is limited to 10% and the value given in condition 3 should read 90%.

5.3 SECOND ORDER EFFECTS WITH AXIAL LOADS

Global second order effects, such as moments induced due to vertical elements, are likely to occur in structures with flexible bracing systems. Elements in which structural behaviour is significantly influenced by second order effects includes columns, walls, piles, arches and shells.

Where second order effects are taken into account, equilibrium and resistance shall be verified in the deformed state. Deformations shall be calculated taking into account the relevant effects of cracking, non linear material properties and creep.

Where relevant, analysis shall include the effect of flexibility of adjacent members and foundations (i.e. soil structure interaction). The structural behaviour shall be considered in the direction in which deformations can occur, and biaxial bending shall be taken into account where necessary.

Second order effects may be ignored if they are less than 10% of the corresponding first order effects.

5.4 SHEAR WALLS

Shear walls are plain or reinforced concrete walls which contribute to the lateral stability of the structure.

Lateral load resisted by each shear wall in a structure should be obtained from a global analysis of the structure, taking into account the applied loads, the eccentricities of the loads with respect to the shear centre of the structure and the interaction between the different structural walls.

The effects of asymmetry of the structure should also be considered.

The combined effects of axial loading and shear should be taken into account.

In addition to other serviceability criteria in this code, the effect of sway of shear walls on the occupants of the structure should also be considered (see section 7).

5.5 TRANSFER STRUCTURES

Transfer structures are horizontal elements which redistribute vertical loads where there is a discontinuity between the vertical structural elements above and below. In the analysis of transfer structures, consideration should be given to the following:

- (a) construction and pouring sequence;
- (b) temporary and permanent loading conditions;

- (c) varying axial shortening of elements supporting the transfer structure;
- (d) local effect of shear walls on the transfer structure;
- (e) stiffness of structural elements above and below the transfer structure;
- (f) deflection of the transfer structure;
- (g) relative lateral deflection at the transfer structure level with respect to the storey below, which should not exceed $H_s/700$, where H_s is the height of the storey below the transfer structure;
- (h) lateral shear forces on the transfer structure; and
- (i) sidesway of the transfer structure under lateral loads.

5.6 PRECAST ELEMENTS

For design of precast elements, refer to the Code of Practice for Precast Concrete Construction.

6 ULTIMATE LIMIT STATES

6.1 MEMBERS IN FLEXURE

6.1.1 General

The following clauses deal with the design of members predominantly in flexure i.e. beams and slabs. The design of slab elements has been separated into the various slab types namely solid slabs (clause 6.1.3), ribbed slabs (clause 6.1.4) and flat slabs (clause 6.1.5). The general requirements for design for moment and shear are given in clause 6.1.2 for beams. Where additional requirements are required for each type of slab, these are given in the relevant clauses.

6.1.2 Beams

6.1.2.1 General

(a) Design limitations

This sub-clause deals with the design of beams of normal proportions. Deep beams (see clause 5.2.1.1(a)) are not considered. For the design of deep beams, reference should be made to specialist literature.

(b) Effective span of beams

The effective span of a beam should be taken as stated in clause 5.2.1.2 (b).

(c) Effective width of flanged beam

These should be as specified in clause 5.2.1.2 (a).

(d) Slenderness limits for beams for lateral stability

The clear distance between restraints should not exceed:

- (i) for simply-supported or continuous beams: $60b_c$ or $250b_c^2/d$ if less; or
- (ii) for cantilevers with lateral restraint only at support: $25b_c$ or $100b_c^2/d$ if less.

6.1.2.2 Continuous beams

Continuous beams may be analysed in accordance with section 5 or designed and detailed to resist the moments and shear forces given by clause 6.1.2.3, as appropriate.

6.1.2.3 Uniformly-loaded continuous beams with approximately equal spans: moments and shears

Table 6.1 may be used to calculate the design ultimate bending moments and shear forces, subject to the following provisions:

- (a) characteristic imposed load Q_k may not exceed characteristic dead load G_k ;
- (b) loads should be substantially uniformly distributed over three or more spans; and
- (c) variations in span length should not exceed 15% of longest.

| | At outer support | Near middle of end span | At first interior support | At middle of interior spans | At interior supports |
|--|------------------|-------------------------|---------------------------|-----------------------------|----------------------|
| Moment | 0 | $0.09Fl$ | $-0.11Fl$ | $0.07Fl$ | $-0.08Fl$ |
| Shear | $0.45F$ | - | $0.6F$ | - | $0.55F$ |
| Note: | | | | | |
| 1. No redistribution of the moments calculated from this table should be made. | | | | | |

Table 6.1 - Design ultimate bending moments and shear forces

6.1.2.4 Design resistance moment of beams

(a) Analysis of sections

In the analysis of a cross-section to determine its ultimate moment of resistance the following assumptions should be made:

- (i) the strain distribution in the concrete in compression and the strains in the reinforcement, whether in tension or compression, are derived from the assumption that plane sections remain plane;

- (ii) the stresses in the concrete in compression may be derived from the stress-strain curve in Figure 3.8 with $\gamma_m = 1.5$. Alternatively, the simplified stress block illustrated in Figure 6.1 may be used;
- (iii) the tensile strength of the concrete is ignored;
- (iv) the stresses in the reinforcement are derived from the stress-strain curve in Figure 3.9 with $\gamma_m = 1.15$; and
- (v) where a section is designed to resist only flexure, the lever arm should not be assumed to be greater than 0.95 times the effective depth.

In the analysis of a cross-section of a beam that has to resist a small axial thrust, the effect of the design ultimate axial force may be ignored if it does not exceed $0.1f_{cu}$ times the cross-sectional area.

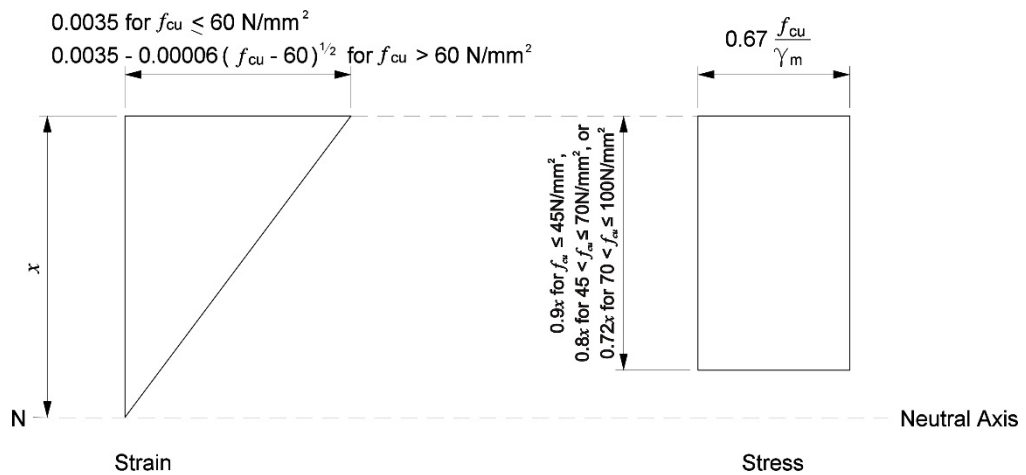

Figure 6.1 - Simplified stress block for concrete at ultimate limit state

(b) Limitation on depth of neutral axis

In order to ensure large strains are developed in the tensile reinforcement, the depth of the neutral axis from the compression face should be limited.

Where redistribution of moments is not carried out or does not exceed 10%, the depth to the neutral axis, x , should be limited as follows:

$$x \leq 0.5d \text{ for } f_{cu} \leq 45 \text{ N/mm}^2; \quad 6.1$$

$$x \leq 0.4d \text{ for } 45 < f_{cu} \leq 70 \text{ N/mm}^2; \text{ or} \quad 6.2$$

$$x \leq 0.33d, \text{ for } 70 < f_{cu} \leq 100 \text{ N/mm}^2 \text{ and no moment redistribution.} \quad 6.3$$

Where redistribution of moments exceeds 10%, the depth to the neutral axis, x , should be limited as follows:

$$x \leq (\beta_b - 0.4)d \text{ for } f_{cu} \leq 45 \text{ N/mm}^2; \text{ or} \quad 6.4$$

$$x \leq (\beta_b - 0.5)d \text{ for } 45 < f_{cu} \leq 70 \text{ N/mm}^2; \quad 6.5$$

where:

$$\beta_b = \frac{\text{moment at the section after redistribution}}{\text{moment at the section before redistribution}} \quad 6.6$$

(c) Design formulae for rectangular beams

The following equations, which are based on the simplified stress block of Figure 6.1, are also applicable to flanged beams where the neutral axis lies within the flange.

$$K = M/bd^2f_{cu} \quad 6.7$$

Where redistribution of moments is not carried out or does not exceed 10%:

$$K' = 0.156 \text{ for } f_{cu} \leq 45 \text{ N/mm}^2 \text{ ; or} \quad 6.8$$

$$0.120 \text{ for } 45 < f_{cu} \leq 70 \text{ N/mm}^2 \text{ ; or}$$

$$0.094 \text{ for } 70 < f_{cu} \leq 100 \text{ N/mm}^2 \text{ and no moment redistribution}$$

Where redistribution exceeds 10%,

$$K' = 0.402(\beta_b - 0.4) - 0.18(\beta_b - 0.4)^2, \text{ for } f_{cu} \leq 45 \text{ N/mm}^2 \text{ ; or} \quad 6.9$$

$$0.357(\beta_b - 0.5) - 0.143(\beta_b - 0.5)^2 \text{ for } 45 < f_{cu} \leq 70 \text{ N/mm}^2.$$

If $K \leq K'$, compression reinforcement is not required and:

$$z = d \left(0.5 + \sqrt{0.25 - \frac{K}{0.9}} \right) \quad 6.10$$

but not greater than $0.95d$.

$$x = (d - z)/0.45, \text{ for } f_{cu} \leq 45 \text{ N/mm}^2 \text{ ; or} \quad 6.11$$

$$(d - z)/0.40, \text{ for } 45 < f_{cu} \leq 70 \text{ N/mm}^2 \text{ ; or}$$

$$(d - z)/0.36, \text{ for } 70 < f_{cu} \leq 100 \text{ N/mm}^2.$$

$$A_s = M / 0.87 f_y z \quad 6.12$$

If $K > K'$, compression reinforcement is required and:

$$z = d \left(0.5 + \sqrt{0.25 - \frac{K'}{0.9}} \right) \quad 6.13$$

$$x = (d - z)/0.45, \text{ for } f_{cu} \leq 45 \text{ N/mm}^2 \text{ ; or} \quad 6.14$$

$$(d - z)/0.40, \text{ for } 45 < f_{cu} \leq 70 \text{ N/mm}^2 \text{ ; or}$$

$$(d - z)/0.36, \text{ for } 70 < f_{cu} \leq 100 \text{ N/mm}^2$$

$$A_s' = \frac{(K - K')f_{cu}b_c d^2}{0.87 f_y (d - d')} \quad 6.15$$

$$A_s = \frac{K' f_{cu} b_c d^2}{0.87 f_y z} + A_s' \quad 6.16$$

The compression stress will be less than $0.87 f_y$ and should be obtained from Figure 3.9 if d'/x exceeds the value given in the following expression (for $f_y = 500 \text{ N/mm}^2$):

$$1 - \frac{2.175 \times 10^{-3}}{\varepsilon_{cu}} \quad (= 0.38 \text{ for } f_{cu} \leq 60 \text{ N/mm}^2)$$

where ε_{cu} is the maximum concrete strain at ultimate limit state (see Figure 3.8 or 6.1).

(d) Design formulae for flanged beams where the neutral axis falls below the flange

Provided that the design ultimate moment is less than $\beta_f f_{cu} b d^2$ and that not more than 10% of redistribution has been carried out, the required area of tension steel may be calculated using the following equation:

$$A_s = \frac{M + k_1 f_{cu} b_w d (k_2 d - h_f)}{0.87 f_y (d - 0.5 h_f)} \quad 6.17$$

where $k_1 = 0.1$ for $f_{cu} \leq 45 \text{ N/mm}^2$, 0.072 for $45 < f_{cu} \leq 70 \text{ N/mm}^2$ and 0.054 for $70 < f_{cu} \leq 100 \text{ N/mm}^2$;

and $k_2 = 0.45$ for $f_{cu} \leq 45 \text{ N/mm}^2$, 0.32 for $45 < f_{cu} \leq 70 \text{ N/mm}^2$ and 0.24 for $70 < f_{cu} \leq 100 \text{ N/mm}^2$

Equation 6.17 is only applicable when $k_2d - h_f$ is positive.

If the design ultimate moment exceeds $\beta_f f_{CU} b d^2$ or more than 10% redistribution has been carried out, the section may be designed by direct application of the assumptions given in clause 6.1.2.4 (a). β_f in this expression is a factor given in equation 6.18.

The value of β_f is calculated from the following equation:

$$\beta_f = 0.45 \frac{h_f}{d} \left(1 - \frac{b_w}{b} \right) \left(1 - \frac{h_f}{2d} \right) + K' \frac{b_w}{b} \quad 6.18$$

6.1.2.5 Design shear resistance of beams

(a) Shear stress in beams

The design shear stress v at any cross-section should be calculated from:

$$v = \frac{V}{b_v d} \quad 6.19$$

where:

b_v breadth of section (for a flanged beam this should be taken as the average width of the rib below the flange).

In no case should v exceed $0.8\sqrt{f_{CU}}$ or 7.0 N/mm^2 , whichever is the lesser, whatever shear reinforcement is provided (this limit includes an allowance for γ_m of 1.25).

(b) Shear reinforcement: form, area and stress

Shear reinforcement should be as given in Table 6.2

| Value of v (N/mm ²) | Form of shear reinforcement to be provided | Area of shear reinforcement to be provided |
|---|---|--|
| $v < 0.5v_c$ throughout the beam | See note 1 | -- |
| $0.5v_c < v < (v_c + v_r)$ (See note 2) | Minimum links for whole length of beam | $A_{SV} \geq v_r b_v s_v / 0.87 f_{yV}$ (See note 2) |
| $(v_c + v_r) < v < 0.8\sqrt{f_{CU}}$, or 7.0 N/mm^2 | Links or links combined with bent-up bars. Not more than 50% of the shear resistance provided by the steel may be in the form of bent-up bars (See note 3) | Where links only provided: $A_{SV} \geq b_v s_v (v - v_c) / 0.87 f_{yV}$ Where links and bent-up bars provided: see clause 6.1.2.5 (e) |
| Notes: | | |
| 1. While minimum links should be provided in all beams of structural importance, it will be satisfactory to omit them in members of minor structural importance such as lintels or where the maximum design shear stress is less than half v_c | | |
| 2. Minimum links provide a design shear resistance of v_r where $v_r = 0.4$ for $f_{CU} \leq 40 \text{ N/mm}^2$ or $0.4(f_{CU}/40)^{2/3}$ for $f_{CU} > 40 \text{ N/mm}^2$ but with the value of f_{CU} not to be taken as greater than 80 N/mm^2 | | |
| 3. See clause 6.1.2.5 (d) for guidance on spacing of links and bent-up bars. | | |

Table 6.2 - Form and area of shear reinforcement in beams

(c) Concrete shear stresses

Values for the design concrete shear stress v_c (in N/mm²) are given in Table 6.3.

The term A_s is that area of longitudinal tension reinforcement which continues for a distance at least equal to d beyond the section being considered. At supports, the full area of tension reinforcement at the section may be applied in the table provided the requirements for curtailment and anchorage of reinforcement are met (see sections 8 and 9 where general recommendations and simplified rules are given).

At a monolithic beam-column junction where the beam has been designed on the assumption that the column provides a simple support but where some nominal top steel has been provided to control cracking, v_c may be calculated on the basis of the area of the bottom steel at the support provided that this has been anchored in accordance with the rules for detailing simply-supported ends given in clause 8.4. If this anchorage has not been provided then v_c should be calculated on the basis of the top steel. This steel should extend into the span for a distance of at least three times the effective depth from the face of the support.

(d) Spacing of links (see Table 6.2)

The spacing of links in the direction of the span should not exceed $0.75d$. At right-angles to the span, the horizontal spacing should be such that no longitudinal tension bar is more than 150 mm from a vertical leg; this spacing should in any case not exceed d .

| $\frac{100A_s}{b_v d}$ | Effective depth (mm) | | | | | | | |
|------------------------|-------------------------|-------------------|-------------------|-------------------|-------------------|-------------------|-------------------|-------------------|
| | 125 | 150 | 175 | 200 | 225 | 250 | 300 | 400 |
| | N/mm ² | N/mm ² | N/mm ² | N/mm ² | N/mm ² | N/mm ² | N/mm ² | N/mm ² |
| ≤0.15 | 0.45 | 0.43 | 0.41 | 0.40 | 0.39 | 0.38 | 0.36 | 0.34 |
| 0.25 | 0.53 | 0.51 | 0.49 | 0.47 | 0.46 | 0.45 | 0.43 | 0.40 |
| 0.50 | 0.67 | 0.64 | 0.62 | 0.60 | 0.58 | 0.56 | 0.54 | 0.50 |
| 0.75 | 0.77 | 0.73 | 0.71 | 0.68 | 0.66 | 0.65 | 0.62 | 0.57 |
| 1.00 | 0.84 | 0.81 | 0.78 | 0.75 | 0.73 | 0.71 | 0.68 | 0.63 |
| 1.50 | 0.97 | 0.92 | 0.89 | 0.86 | 0.83 | 0.81 | 0.78 | 0.72 |
| 2.00 | 1.06 | 1.02 | 0.98 | 0.95 | 0.92 | 0.89 | 0.86 | 0.80 |
| ≥3.00 | 1.22 | 1.16 | 1.12 | 1.08 | 1.05 | 1.02 | 0.98 | 0.91 |

Notes:

- Allowance has been made in these figures for a γ_m of 1.25.
- The values in the table are derived from the expression:
$$0.79 \left(\frac{100A_s}{b_v d} \right)^{\frac{1}{3}} \left(\frac{400}{d} \right)^{\frac{1}{4}} \frac{1}{\gamma_m}$$

where:

 - $\frac{100A_s}{b_v d}$ should not be taken as greater than 3,
 - $\left(\frac{400}{d} \right)^{\frac{1}{4}}$ should not be taken as less than 0.67 for members without shear reinforcement,
 - $\left(\frac{400}{d} \right)^{\frac{1}{4}}$ should not be taken as less than 1 for members with shear reinforcement providing minimum links in accordance with Note 2 in Table 6.2.
- For characteristic concrete strengths greater than 25 N/mm², the values in this table may be multiplied by $(f_{cu}/25)^{1/3}$. The value of f_{cu} should not be taken as greater than 80 N/mm².

Table 6.3 - Values of v_c design concrete shear stress

(e) Shear resistance of bent-up bars

The design shear resistance of a system of bent-up bars may be calculated by assuming that the bent-up bars form the tension members of one or more single systems of trusses in which the concrete forms the compression members (see Figure 6.2). The resistance of a system of bent-up bars is given by the following equation:

$$V_b = A_{sb}(0.87f_{yv})(\cos\alpha + \sin\alpha \cot\beta) \frac{d-d'}{s_b} \quad 6.20$$

where:

- α is the angle between a bent-up bar and the axis of a beam,
 β is the angle between the 'compression strut' of a system of bent-up bars and the axis of the beam. The truss should be arranged so that α and β are both equal to or greater than 45° giving a maximum value of s_t of $1.5d$. At least 50% of the shear resistance provided by the reinforcement should be in the form of links.

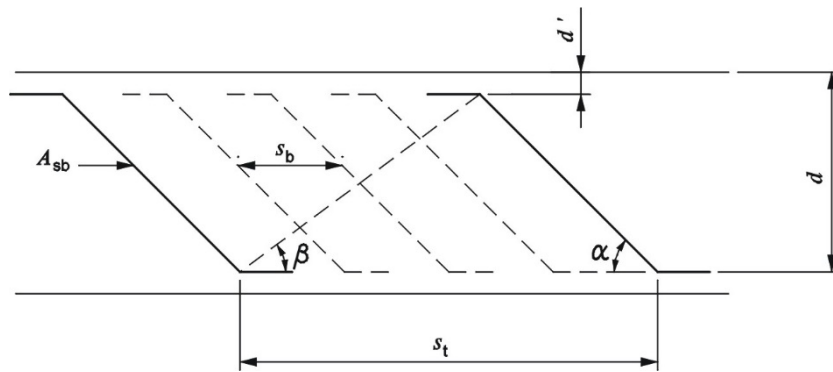

Figure 6.2 - System of bent-up bars

(f) Anchorage and bearing of bent-up bars

Bars should be checked for anchorage (see clause 8.4.2) and bearing (see clause 8.3).

(g) Enhanced shear strength of sections close to supports

Shear failure at sections of beams and cantilevers without shear reinforcement will normally occur on a plane inclined at an angle of about 30° to the horizontal. If the angle of failure plane is forced to be inclined more steeply than this (because the section considered ($x-x$) in Figure 6.3 is close to a support or for other reasons) the shear force required to produce failure is increased.

The enhancement of shear strength may be taken into account in the design of sections near a support by increasing the design concrete shear stress v_c to $2dv_c/a_v$, where a_v is the length of that part of a member traversed by a shear failure plane, provided that v at the face of the support remains less than the lesser of $0.8\sqrt{f_{cu}}$ or 7.0 N/mm^2 (this limit includes a γ_m of 1.25).

Account may be taken of the enhancement in any situation where the section considered is closer to the face of a support or concentrated load than twice the effective depth, d . This enhancement is particularly useful for corbels (see clause 6.5) or pile-caps (see clause 6.7) or where concentrated loads are applied close to the support of a beam.

To be effective, tension reinforcement should extend on each side of the point where it is intersected by a possible failure plane for a distance at least equal to the effective depth, or be provided with an equivalent anchorage.

(h) Shear reinforcement for sections close to supports

If shear reinforcement is required, the total area of this is given by:

$$\sum A_{sv} = a_v b_v \frac{\left(v - \frac{2d}{a_v} v_c \right)}{0.87 f_{yv}} \geq \frac{0.4 b_v a_v}{0.87 f_{yv}} \quad 6.21$$

This reinforcement should be provided within the middle three-quarters of a_v where a_v is less than d horizontal shear reinforcement will be more effective than vertical.

(i) Enhanced shear strength near supports (simplified approach)

The procedures given in clause 6.1.2.5 (g) and (h) may be used for all beams. However, for beams carrying generally uniform load or where the principal load is located further than $2d$ from the face of the support, the shear stress may be calculated at a section a distance d from the face of the support. The value of v_c is calculated in accordance with clause 6.1.2.5 (c) and appropriate shear reinforcement assessed in accordance with Table 6.3. If this amount of shear reinforcement is provided at sections closer to the support, no further check for shear at such sections is required.

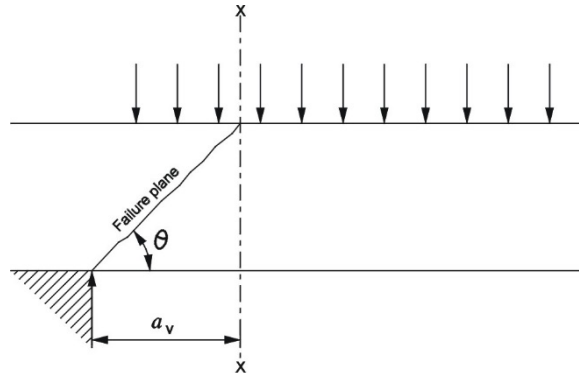

Note : The shear causing failure is that acting on section x-x.

Figure 6.3 - Shear failure near supports

(j) Bottom loaded beams

Where load is applied near the bottom of a section, sufficient vertical reinforcement to carry the load should be provided in addition to any reinforcement required to resist shear.

(k) Shear and axial load

The design shear stress v_c' that can be supported by a section subjected to shear and axial compression without shear reinforcement can be calculated from equation 6.22. Both adverse and beneficial load combinations should be considered (see Table 2.1).

$$v_c' = v_c + 0.6 \frac{NVh}{A_c M} \tag{6.22}$$

where:

- v_c' is the design concrete shear stress corrected to allow for axial forces,
- v_c is the shear stress obtained from Table 6.3. This should not be adjusted in accordance with clause 6.1.2.5 (g).

Notes:

1. N/A_c is intended to be the average stress in the concrete acting at the centroid of the section.
2. The value of Vh/M should be taken as not greater than 1.

Where it is considered necessary to avoid shear cracking prior to the ultimate limit state, the shear stress should be limited to the value given by equation 6.23.

$$v_c' = v_c \sqrt{1 + \frac{N}{A_c v_c}} \tag{6.23}$$

If v exceeds v_c' shear reinforcement should be provided in accordance with Table 6.2 where v_c is replaced by v_c' .

v should not exceed $0.8\sqrt{f_{cu}}$ or 7.0 N/mm^2 , whichever is the lesser.

For situations where the axial load is tensile, equations 6.22 and 6.23 may be used with N taken as negative.

(l) Torsion

In normal slab-and-beam or framed construction specific calculations are not usually necessary, torsional cracking being adequately controlled by shear reinforcement but when the design relies on the torsional resistance of a member, explicit design for torsion will be necessary. Recommendations are given in clause 6.3.

6.1.3 Solid slabs supported by beams or walls

6.1.3.1 Design

In general, the recommendations given in clause 6.1.2 for beams will apply also to solid slabs but clauses 6.1.3.2 to 6.2.3.6 should be taken into account.

6.1.3.2 Moments and forces

(a) General

In addition to the methods used for beams, the moments and shear forces resulting from both distributed and concentrated loads may be determined by appropriate elastic analyses. Alternatively, Johansen's yield line method or Hillerborg's strip method may be used provided the ratio between support and span moments are similar to those obtained by the use of the elastic theory.

(b) Distribution of concentrated loads on slabs

If a slab is simply supported on two opposite edges and carries one or more concentrated loads in a line in the direction of the span, it should be designed to resist the maximum bending moment caused by the loading system. Such bending moment may be assumed to be resisted by an effective width of slab (measured parallel to the supports) as follows:

- (i) for solid slabs, the effective width may be taken as the sum of the load width and $2.4x(1 - x/l)$ where x is the distance from the nearer support to the section under consideration and l is the span;
- (ii) for other slabs, except where specially provided for, the effective width will depend on the ratio of the transverse and longitudinal flexural rigidities of the slab. When these are approximately equal, the value for the effective width as given for solid slabs may be used, but as the ratio decreases a smaller value should be taken. The minimum value which need be taken, however, is the load width plus $4x/l(1 - x/l)$ metres where x and l are as defined above so that, for a section at mid-span, the effective width is equal to 1 m plus the load width; and
- (iii) Where the concentrated load is near an unsupported edge of a slab the effective width should not exceed the appropriate value defined above, nor half that value plus the distance of the centre of the load from the unsupported edge (see Figure 6.4).

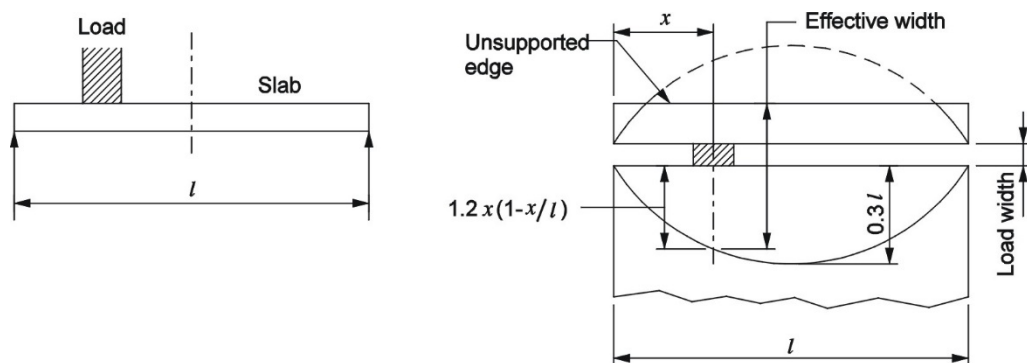

Figure 6.4 - Effective width of solid slab carrying a concentrated load near an unsupported edge

(c) Simplification of load arrangements

In principle a slab should be designed to withstand the most unfavourable arrangements of design loads; however, slabs will normally be able to satisfy this requirement if they are designed

to resist the moments and forces arising from the single-load case of maximum design load on all spans or panels provided the following conditions are met:

- (i) In a one-way spanning slab the area of each bay exceeds 30 m². In this context, a bay means a strip across the full width of a structure bounded on the other two sides by lines of support (see figure 6.5);
- (ii) The ratio of the characteristic imposed load to the characteristic dead load does not exceed 1.25; and
- (iii) The characteristic imposed load does not exceed 5 kN/m² excluding partitions.

Where analysis is carried out for the single load case of all spans loaded, the resulting support moments except those at the supports of cantilevers should be reduced by 20%, with a consequential increase in the span moments.

The resulting bending moment envelope should satisfy the provisions of clause 5.2.9.1. No further redistribution should be carried out.

Where a span or panel is adjacent to a cantilever of significant length, the possibility should be considered of the case of slab unloaded/cantilever loaded.

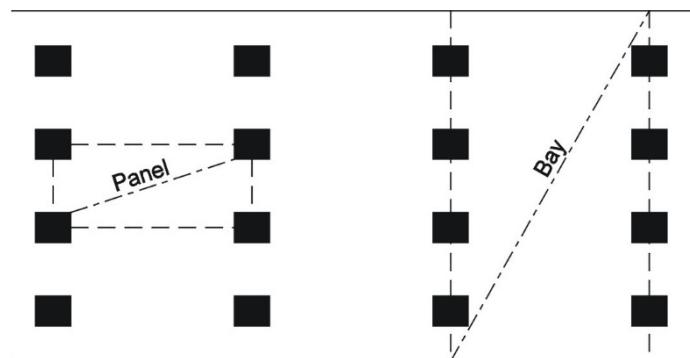

Figure 6.5 - Definition of panels and bays

- (d) One-way spanning slabs of approximately equal span: uniformly distributed loads

Where the conditions of clause 6.1.3.2 (c) are met, the moments and shears in continuous one-way spanning slabs may be calculated using the coefficients given in Table 6.4. Allowance has been made in these coefficients for the 20% redistribution mentioned above.

The curtailment of reinforcement designed in accordance with Table 6.4 may be carried out in accordance with the provisions of Clause 9.3.1.

| | End support/slab connection | | | | At first interior support | Middle interior spans | Interior supports |
|---------------|-----------------------------|-------------------------|------------------|-------------------------|---------------------------|-----------------------|-------------------|
| | Simple | | Continuous | | | | |
| | At outer support | Near middle of end span | At outer support | Near middle of end span | | | |
| Moment | 0 | $0.086Fl$ | $-0.04Fl$ | $0.075Fl$ | $-0.086Fl$ | $0.063Fl$ | $-0.063Fl$ |
| Shear | $0.4F$ | -- | $0.46F$ | -- | $0.6F$ | -- | $0.5F$ |

Table 6.4 - Ultimate bending moment and shear forces in one-way spanning slabs

6.1.3.3 Solid slabs spanning in two directions at right angles: uniformly distributed loads

- (a) General

Subclauses 6.1.3.3 (b) to (g) may be used for the design of slabs spanning in two directions at right angles and supporting uniformly distributed loads.

(b) Simply-supported slabs

When simply-supported slabs do not have adequate provision to resist torsion at the corners, and to prevent the corners from lifting, the maximum moments per unit width are given by the following equations:

$$m_{sx} = \alpha_{sx} n l_x^2 \quad 6.24$$

$$m_{sy} = \alpha_{sy} n l_x^2 \quad 6.25$$

where:

m_{sx} is the maximum design ultimate moments either over supports or at mid-span on strips of unit width and span l_x ,

m_{sy} is the maximum design ultimate moments either over supports or at mid-span on strips of unit width and span l_y ,

l_x is the length of shorter side,

l_y is the length of longer side,

n is the total design ultimate load per unit area,

α_{sx} and α_{sy} are the moment coefficients shown in Table 6.5.

| l_y/l_x | 1.0 | 1.1 | 1.2 | 1.3 | 1.4 | 1.5 | 1.75 | 2.0 |
|---------------|-------|-------|-------|-------|-------|-------|-------|-------|
| α_{sx} | 0.062 | 0.074 | 0.084 | 0.093 | 0.099 | 0.104 | 0.113 | 0.118 |
| α_{sy} | 0.062 | 0.061 | 0.059 | 0.055 | 0.051 | 0.046 | 0.037 | 0.029 |

Table 6.5 - Bending moment coefficients for slabs spanning in two directions at right angles, simply supported on four sides

The values in Table 6.5 are derived from the following equations:

$$\alpha_{sx} = \frac{(l_y/l_x)^4}{8[1+(l_y/l_x)^4]} \quad 6.26$$

$$\alpha_{sy} = \frac{(l_y/l_x)^2}{8[1+(l_y/l_x)^4]} \quad 6.27$$

(c) Restrained slabs

In slabs where the corners are prevented from lifting, and provision for torsion is made, the maximum design moments per unit width are given by the following equations:

$$m_{sx} = \beta_{sx} n l_x^2 \quad 6.28$$

$$m_{sy} = \beta_{sy} n l_x^2 \quad 6.29$$

where:

β_{sx} and β_{sy} are the moment coefficients shown in Table 6.6.

Where these equations are used, the conditions and rules of clause 6.1.3.3 (d) should be applied.

| Type of panel and moments considered | Short span coefficients, β_{sx} | | | | | | | | Long span coefficients, β_{sy} for all values of l_y/l_x |
|--|---------------------------------------|-------|-------|-------|-------|-------|-------|-------|--|
| | Values of l_y/l_x | | | | | | | | |
| | 1.0 | 1.1 | 1.2 | 1.3 | 1.4 | 1.5 | 1.75 | 2.0 | |
| Interior panels | | | | | | | | | |
| Negative moment at continuous edge | 0.031 | 0.037 | 0.042 | 0.046 | 0.050 | 0.053 | 0.059 | 0.063 | 0.032 |
| Positive moment at mid-span | 0.024 | 0.028 | 0.032 | 0.035 | 0.037 | 0.040 | 0.044 | 0.048 | 0.024 |
| One short edge discontinuous | | | | | | | | | |
| Negative moment at continuous edge | 0.039 | 0.044 | 0.048 | 0.052 | 0.055 | 0.058 | 0.063 | 0.067 | 0.037 |
| Positive moment at mid-span | 0.029 | 0.033 | 0.036 | 0.039 | 0.041 | 0.043 | 0.047 | 0.050 | 0.028 |
| One long edge discontinuous | | | | | | | | | |
| Negative moment at continuous edge | 0.039 | 0.049 | 0.056 | 0.062 | 0.068 | 0.073 | 0.082 | 0.089 | 0.037 |
| Positive moment at mid-span | 0.030 | 0.036 | 0.042 | 0.047 | 0.051 | 0.055 | 0.062 | 0.067 | 0.028 |
| Two adjacent edges discontinuous | | | | | | | | | |
| Negative moment at continuous edge | 0.047 | 0.056 | 0.063 | 0.069 | 0.074 | 0.078 | 0.087 | 0.093 | 0.045 |
| Positive moment at mid-span | 0.036 | 0.042 | 0.047 | 0.051 | 0.055 | 0.059 | 0.065 | 0.070 | 0.034 |
| Two short edges discontinuous | | | | | | | | | |
| Negative moment at continuous edge | 0.046 | 0.050 | 0.054 | 0.057 | 0.060 | 0.062 | 0.067 | 0.070 | — |
| Positive moment at mid-span | 0.034 | 0.038 | 0.040 | 0.043 | 0.045 | 0.047 | 0.050 | 0.053 | 0.034 |
| Two long edges discontinuous | | | | | | | | | |
| Negative moment at continuous edge | — | — | — | — | — | — | — | — | 0.045 |
| Positive moment at mid-span | 0.034 | 0.046 | 0.056 | 0.065 | 0.072 | 0.078 | 0.091 | 0.100 | 0.034 |
| Three edges discontinuous (one long edge continuous) | | | | | | | | | |
| Negative moment at continuous edge | 0.057 | 0.065 | 0.071 | 0.076 | 0.081 | 0.084 | 0.092 | 0.098 | — |
| Positive moment at mid-span | 0.043 | 0.048 | 0.053 | 0.057 | 0.060 | 0.063 | 0.069 | 0.074 | 0.044 |
| Three edges discontinuous (one short edge continuous) | | | | | | | | | |
| Negative moment at continuous edge | — | — | — | — | — | — | — | — | 0.058 |
| Positive moment at mid-span | 0.042 | 0.054 | 0.063 | 0.071 | 0.078 | 0.084 | 0.096 | 0.105 | 0.044 |
| Four edges discontinuous | | | | | | | | | |
| Positive moment at mid-span | 0.055 | 0.065 | 0.074 | 0.081 | 0.087 | 0.092 | 0.103 | 0.111 | 0.056 |

Table 6.6 - Bending moment coefficients for rectangular panels supported on four sides with provision for torsion at corners

Equations 6.28 and 6.29 and the coefficients in Table 6.6 may be derived from the following equations:

$$\beta_y = (24 + 2N_d + 1.5N_d^2) / 1000 \quad 6.30$$

$$\gamma = \frac{2}{9} \left[3 - \sqrt{18} \frac{l_x}{l_y} \left(\sqrt{\beta_y + \beta_1} + \sqrt{\beta_y + \beta_2} \right) \right] \quad 6.31$$

$$\sqrt{\gamma} = \sqrt{\beta_x + \beta_3} + \sqrt{\beta_x + \beta_4} \quad 6.32$$

where:

β_x is the sagging moment in the span, per unit width, in the direction of the shorter span, l_x , divided by nl_x^2 ,

β_y is the sagging moment in the span, per unit width, in the direction of the longer span, l_y , divided by nl_x^2 ,

β_1 and β_2 are the hogging moments, per unit width, over the shorter edges divided by nl_x^2 ,

β_3 and β_4 are the hogging moments, per unit width, over the longer edges divided by nl_x^2 ,

N_d is the number of discontinuous edges (0 to 4).

Note: β_1 and β_2 take values of $4/3\beta_y$ for continuous edges or zero for discontinuous edges.

β_3 and β_4 take values of $4/3\beta_x$ for continuous edges or zero for discontinuous edges.

- (d) Restrained slabs where the corners are prevented from lifting and adequate provision is made for torsion: conditions and rules for the use of equations 6.28 and 6.29.

The conditions in which the equations may be used for continuous slabs only are as follows.

- (i) The characteristic dead and imposed loads on adjacent panels are approximately the same as on the panel being considered;
 - (ii) The span of adjacent panels in the direction perpendicular to the line of the common support is approximately the same as the span of the panel considered in that direction.
- (e) The rules to be observed when the equations are applied to restrained slabs (continuous or discontinuous) are as follows.
- (i) Slabs are considered as divided in each direction into middle strips and edge strips as shown in Figure 6.6, the middle strip being three-quarters of the width and each edge strip one-eighth of the width.
 - (ii) The maximum design moments calculated as above apply only to the middle strips and no redistribution should be made.
 - (iii) Reinforcement in the middle strips should be detailed in accordance with clause 9.3.1.2 (curtailment of bars).
 - (iv) Reinforcement in an edge strip, parallel to the edge, need not exceed the minimum given in clause 9.3.1.1 (a) (minimum areas of tension reinforcement), together with the recommendations for torsion given in (v) to (vii) below.
 - (v) Torsion reinforcement should be provided at any corner where the slab is simply supported on both edges meeting at that corner. It should consist of top and bottom reinforcement, each with layers of bars placed parallel to the sides of the slab and extending from the edges a minimum distance of one-fifth of the shorter span. The area of reinforcement in each of these four layers should be three-quarters of the area required for the maximum mid-span design moment in the slab.
 - (vi) Torsion reinforcement equal to half that described in the preceding paragraph should be provided at a corner contained by edges over only one of which the slab is continuous.

- (vii) Torsion reinforcement need not be provided at any corner contained by edges over both of which the slab is continuous.

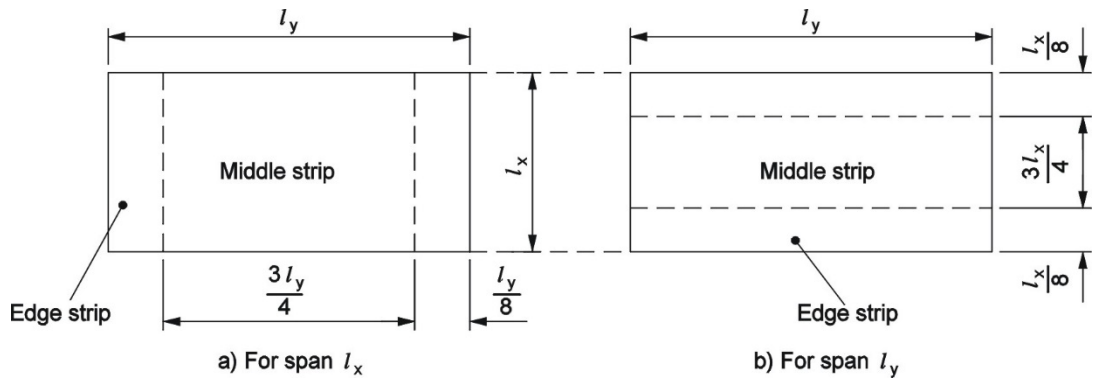

Figure 6.6 - Division of slab into middle and edge strips

- (f) Restrained slab with unequal conditions at adjacent panels

In some cases the support moments calculated from Table 6.6, for adjacent panels, may differ significantly. To adjust them the following procedures may be used:

- (i) calculate the sum of the mid-span moment and the average of the support moments (neglecting signs) for each panel,
- (ii) treat the values from Table 6.6 as fixed end moments (FEMs),
- (iii) distribute the FEMs across the supports according to the relative stiffness of adjacent spans, giving new support moments,
- (iv) adjust mid-span moment for each panel: this should be such that when it is added to the average of the support moments from (iii) (neglecting signs) the total equals that from (i).

If, for a given panel, the resulting support moments are now significantly greater than the value from Table 6.6, the tension steel over the supports will need to be extended beyond the provisions of clause 9.3.1.2. The procedure should be as follows:

- (v) The span moment is taken as parabolic between supports; its maximum value is as found from (iv),
- (vi) The points of contraflexure of the new support moments (from (iii)) with the span moment (from (v)) are determined,
- (vii) At each end half the support tension steel is extended to at least an effective depth or 12 bar diameters beyond the nearest point of contraflexure,
- (viii) At each end the full area of the support tension steel is extended to half the distance from (vii).

- (g) Loads on supporting beams

The design loads on beams supporting solid slabs spanning in two directions at right angles and supporting uniformly distributed loads may be assessed from the following equations:

$$v_{sy} = \beta_{vy}nl_x \quad 6.33$$

$$v_{sx} = \beta_{vx}nl_x \quad 6.34$$

where:

v_{sx} is the design end shear on strips of unit width and span l_x and considered to act over the middle three-quarters of the supporting beam,

v_{sy} is the design end shear on strips of unit width and span l_y and considered to act over the middle three-quarters of the supporting beam,

β_{vx} and β_{vy} are the shear force coefficients shown in Table 6.7.

Where design ultimate support moments are used which differ substantially from those that would be assessed from Table 6.6, adjustment of the values given in Table 6.7 may be necessary. The assumed distribution of the load on a supporting beam is shown in Figure 6.7.

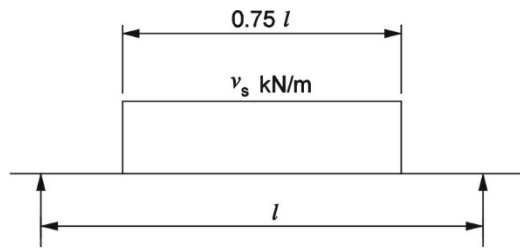

NOTE

$$v_s = v_{sx} \text{ when } l = l_y; v_s = v_{sy} \text{ when } l = l_x;$$

Figure 6.7 - Distribution of load on a beam supporting a two-way spanning slabs

6.1.3.4 Resistance moment of solid slabs

The design ultimate resistance moment of a cross-section of a solid slab may be determined by the methods given in 6.1.2.4 for beams.

| Type of panel and location | β_{vx} for values of l_y / l_x | | | | | | | | β_{vy} |
|---|--|------|------|------|------|------|------|------|--------------|
| | 1.0 | 1.1 | 1.2 | 1.3 | 1.4 | 1.5 | 1.75 | 2.0 | |
| Four edges continuous | | | | | | | | | |
| Continuous edge | 0.33 | 0.36 | 0.39 | 0.41 | 0.43 | 0.45 | 0.48 | 0.50 | 0.33 |
| One short edge discontinuous | | | | | | | | | |
| Continuous edge | 0.36 | 0.39 | 0.42 | 0.44 | 0.45 | 0.47 | 0.50 | 0.52 | 0.36 |
| Discontinuous edge | — | — | — | — | — | — | — | — | 0.24 |
| One long edge discontinuous | | | | | | | | | |
| Continuous edge | 0.36 | 0.40 | 0.44 | 0.47 | 0.49 | 0.51 | 0.55 | 0.59 | 0.36 |
| Discontinuous edge | 0.24 | 0.27 | 0.29 | 0.31 | 0.32 | 0.34 | 0.36 | 0.38 | — |
| Two adjacent edges discontinuous | | | | | | | | | |
| Continuous edge | 0.40 | 0.44 | 0.47 | 0.50 | 0.52 | 0.54 | 0.57 | 0.60 | 0.40 |
| Discontinuous edge | 0.26 | 0.29 | 0.31 | 0.33 | 0.34 | 0.35 | 0.38 | 0.40 | 0.26 |
| Two short edges discontinuous | | | | | | | | | |
| Continuous edge | 0.40 | 0.43 | 0.45 | 0.47 | 0.48 | 0.49 | 0.52 | 0.54 | — |
| Discontinuous edge | — | — | — | — | — | — | — | — | 0.26 |
| Two long edges discontinuous | | | | | | | | | |
| Continuous edge | — | — | — | — | — | — | — | — | 0.40 |
| Discontinuous edge | 0.26 | 0.30 | 0.33 | 0.36 | 0.38 | 0.40 | 0.44 | 0.47 | — |
| Three edges discontinuous (one long edge discontinuous) | | | | | | | | | |
| Continuous edge | 0.45 | 0.48 | 0.51 | 0.53 | 0.55 | 0.57 | 0.60 | 0.63 | — |
| Discontinuous edge | 0.30 | 0.32 | 0.34 | 0.35 | 0.36 | 0.37 | 0.39 | 0.41 | 0.29 |
| Three edges discontinuous (one short edge discontinuous) | | | | | | | | | |
| Continuous edge | — | — | — | — | — | — | — | — | 0.45 |
| Discontinuous edge | 0.29 | 0.33 | 0.36 | 0.38 | 0.40 | 0.42 | 0.45 | 0.48 | 0.30 |
| Four edges discontinuous | | | | | | | | | |
| Discontinuous edge | 0.33 | 0.36 | 0.39 | 0.41 | 0.43 | 0.45 | 0.48 | 0.50 | 0.33 |

Table 6.7 - Shear force coefficient for uniformly loaded rectangular panels supported on four sides with provision for torsion at corners

6.1.3.5 Shear resistance of solid slabs

(a) Shear stresses

The design shear stress v at any cross-section should be calculated from equation 6.35:

$$v = \frac{V}{bd} \quad 6.35$$

In no case should v exceed $0.8\sqrt{f_{cu}}$ or 7.0 N/mm^2 , whichever is the lesser, whatever shear reinforcement is provided.

(b) Shear reinforcement

Recommendations for shear reinforcement in solid slabs are given in Table 6.8.

| Value of v (N/mm^2) | Form of shear reinforcement to be provided | Area of shear reinforcement to be provided |
|--|---|---|
| $v < v_c$ | None required | None |
| $v_c < v < v_c + v_r$ | Minimum links in areas where $v > v_c$ | $A_{sv} \geq v_r b_s v / 0.87 f_{yv}$ |
| $v_c + v_r < v < 0.8\sqrt{f_{cu}}$, or 7.0 N/mm^2 | Links and/or bent-up bars in any combination (but the spacing between links or bent-up bars need not be less than d) | Where links only provided: $A_{sv} \geq b_s v (v - v_c) / 0.87 f_{yv}$ Where bent-up bars only provided: $A_{sb} \geq b_s b (v - v_c) / \{0.87 f_{yv} (\cos \alpha + \sin \alpha \cot \beta)\}$ (see clause 6.1.2.5 (e)) |
| Notes: 1. $v_r = 0.4$ for $f_{cu} \leq 40 \text{ N/mm}^2$ or $0.4(f_{cu}/40)^{2/3}$ for $f_{cu} > 40 \text{ N/mm}^2$ with the value of f_{cu} not to be taken as greater than 80 N/mm^2 2. It is difficult to bend and fix shear reinforcement so that its effectiveness can be assured in slabs less than 200 mm deep. It is therefore not advisable to use shear reinforcement in such slabs. 3. The enhancement in design shear strength close to supports described in clauses 6.1.2.5 (g) to (i) may also be applied to solid slabs. | | |

Table 6.8 - Form and area of shear reinforcement in solid slabs

6.1.3.6 Shear in solid slabs under concentrated loads

The provisions of clause 6.1.5.7 may be applied.

6.1.4 Ribbed slabs

6.1.4.1 General

(a) Introduction

The term "ribbed slab" in this sub-clause refers to insitu slabs constructed in one of the following ways:

- (i) Where topping is considered to contribute to structural strength (see Table 6.9 for minimum thickness):
 - (1) as a series of concrete ribs cast insitu between blocks which remain part of the completed structure; the tops of the ribs are connected by a topping of concrete of the same strength as that used in the ribs;
 - (2) as a series of concrete ribs with topping cast on forms which may be removed after the concrete has set; or
 - (3) with a continuous top and bottom face but containing voids of rectangular, oval or other shape.
- (ii) Where topping is not considered to contribute to structural strength: as a series of concrete ribs cast insitu between blocks which remain part of the completed structure;

the tops of the ribs may be connected by a topping of concrete (not necessarily of the same strength as that used in the ribs).

(b) Hollow or solid blocks and formers

Hollow or solid blocks and formers may be of any suitable material but, when required to contribute to the structural strength of a slab, they should:

- (i) be made of concrete or burnt clay;
- (ii) have a characteristic strength of at least 14 N/mm², measured on the net section, when axially loaded in the direction of compressive stress in the slab; and
- (iii) when made of fired brickearth, clay or shale, conform to the acceptable standards.

(c) Spacing and size of ribs

In situ ribs should be spaced at centres not exceeding 1.5 m and their depth, excluding any topping, should not exceed four times their width. The minimum width of rib will be determined by considerations of cover, bar spacing and fire.

(d) Non-structural side support

Where the side of a slab is built into a wall or rests on a beam parallel to the ribs, that side should be strengthened by the formation of a rib of width equal to that of the bearing.

(e) Thickness of topping used to contribute to structural strength

The thickness after any necessary allowance has been made for wear, should be not less than those of Table 6.9.

(f) Hollow block slabs where topping is not used to contribute to structural strength

When a slab is constructed to b) of Table 6.9 the blocks should conform to clause 6.1.4.1 (b). In addition the thickness of the block material above its void should be not less than 20 mm nor less than one-tenth of the dimension of the void measured transversely to the ribs. The overall thickness of the block and topping (if any) should be not less than one-fifth of the distance between ribs.

| Type of slab | Minimum thickness of topping (mm) |
|--|--|
| Slabs with permanent blocks | |
| As described in clause 6.1.4.1 (a) (1) and clause 6.1.4.1 (b) | |
| a) Clear distance between ribs not more than 500 mm jointed in cement: sand mortar not weaker than 1:3 or 11 N/mm ² | 25 |
| b) Clear distance between ribs not more than 500 mm, not jointed in cement: sand mortar | 30 |
| c) All other slabs with permanent blocks | 40 or one-tenth of clear distance between ribs, whichever is greater |
| All slabs without permanent blocks | |
| As described in clause 6.1.4.1 (a) (2) and (3) | 50 or one-tenth of clear distance between ribs, whichever is greater |

Table 6.9 - Minimum thickness of structural toppings

6.1.4.2 *Analysis of structure*

The moments and forces due to design ultimate loads on continuous slabs may be obtained by any of the methods given in clause 6.1.3.2 for solid slabs. Where the slabs are ribbed and with equal structural properties (bending and twisting) in two mutually perpendicular directions, they may be designed as two-way spanning in accordance with clause 6.1.3.3 or as flat slabs in accordance with clause 6.1.5, whichever is the more appropriate.

Alternatively, if it is impracticable to provide sufficient reinforcement to develop the full design support moment, the slabs may be designed as a series of simply supported spans. If this is done, sufficient reinforcement should be provided over the support to control cracking. It is recommended that such

reinforcement should have an area of not less than 25% of that in the middle of the adjoining spans and should extend at least 15% of the spans into the adjoining spans.

6.1.4.3 Design resistance moments

The provisions given in clause 6.1.2.4 for determining the design ultimate resistance moment of beams may be used. In the analysis of sections the stresses in burnt clay blocks or solid blocks in the compression zone may be taken as 0.25 times the strength determined in clause 6.1.4.1 (b); however, when evidence is available to show that not more than 5% of the blocks have strength below a specified crushing strength, the stress may be taken as 0.3 times that strength.

6.1.4.4 Shear

(a) Flat slab construction

If the design assumes this method, clause 6.1.5.6 should be used. Where a perimeter cuts any ribs, they should each be designed to resist an equal proportion of the applied effective design shear force. Shear links in the ribs should continue for a distance of at least d into the solid area.

(b) One- or two-way spanning slabs

The design shear stress v should be calculated from equation 6.36:

$$v = \frac{V}{b_v d} \quad 6.36$$

where

V is the design shear force due to design ultimate loads on a width of slab equal to the centre distance between ribs,

b_v is the average width of the rib,

d is the effective depth.

(c) Shear contribution by hollow blocks

In equation 6.36, b_v may be increased by the wall thickness of the block on one side of the rib

(d) Shear contribution from solid blocks

Where blocks satisfy clause 6.1.4.1 (b), b_v in equation 6.36 may be increased by one-half of the rib depth on each side of the rib.

(e) Shear contribution by joints between narrow precast units

In equation 6.36, b_v may be increased by the width of mortar or concrete joint.

(f) Maximum design shear stress

In no case should v exceed $0.8\sqrt{f_{cu}}$ or 7.0 N/mm^2 , whichever is the lesser (this includes an allowance for γ_m of 1.25).

(g) Area of shear reinforcement in ribbed hollow block or voided slabs

No shear reinforcement is required when v is less than v_c (where v_c is obtained from Table 6.3).

When v equals or exceeds v_c reinforcement conforming to Table 6.8 should be provided.

6.1.4.5 Arrangement of reinforcement

(a) Curtailment of bars

The reinforcement should be curtailed in accordance with clause 9.3.1.2.

(b) Reinforcement in topping for ribbed or hollow block slabs

Consideration should be given to providing a single layer of welded steel fabric, having a cross-sectional area of not less than 0.12% of the topping, in each direction; the spacing between wires should not be greater than half the centre-to-centre distance between ribs.

(c) Links in ribs

Provided the geometry satisfies clause 6.1.4.1 (c), ribs reinforced with a single bar or ribs in waffle slabs do not require links unless shear or fire resistance requirements so dictate. However

consideration should be given to the use of purpose made spacers occupying the full width of the rib to ensure correct cover to the bar.

Where two or more bars are used in a rib, the use of link reinforcement in addition to normal spacers is recommended except in waffle slabs, to ensure correct cover to reinforcement. The spacing of the links can generally be of the order of 1 m to 1.5 m depending on the diameter of the main bars.

The cover of the link reinforcement should satisfy the durability requirements of section 4 but need not satisfy the requirements for fire resistance in section 4 provided the cover to the main bars does so.

6.1.5 Flat slabs

6.1.5.1 General

(a) Design

Provisions are given for the design of flat slabs supported by a generally rectangular arrangement of columns using the equivalent frame method and where the ratio of the longer to the shorter spans does not exceed 2. Other approaches to the design of flat slabs are acceptable; for example, design based on the methods referred to in clause 6.1.3.2 (a) or on a finite element analysis. In such cases, the applicability of the provisions given in this section is a matter of judgement. Further provisions for waffle or coffered slabs are given in clause 6.1.4.

(b) Column head

For the purposes of clause 6.1.5, the dimensions of a column head which may be considered to be effective are limited according to the depth of the head.

In any direction, the effective dimension of a head l_h should be taken as the lesser of the actual dimension l_{h0} or $l_{h \max}$ where $l_{h \max}$ (in mm) is given by:

$$l_{h \max} = l_c + 2(d_h - 40) \quad 6.37$$

where:

d_h depth of the head,

l_c dimensions of the column measured in the same direction as l_h ,

l_h effective dimension of a head.

For a flared head, the actual dimension l_{h0} is that measured 40 mm below the soffit of the slab or drop (see Figure 6.8).

(c) Effective diameter of a column or column head, h_c

The effective diameter of a column or column head is the diameter of a circle whose area equals the cross-sectional area of the column or, if column heads are used, the area of the column head based on the effective dimensions as defined in clause 6.1.5.1 (b). In no case should h_c be taken as greater than one-quarter of the shortest span framing into the column.

(d) Drops

For the purposes of clause 6.1.5, a drop may only be considered to influence the distribution of moments within the slab where the smaller dimension of the drop is at least one-third of the smaller dimension of the surrounding panels. Smaller drops may, however, still be taken into account when assessing the resistance to punching shear.

(e) Thickness of panels

The thickness of the slab will generally be controlled by consideration of deflection (see clause 7.3). In no case, however, should the thickness of the slab be less than 125 mm. Clause 6.1.4.1 gives further limitations applicable to waffle or coffered slabs.

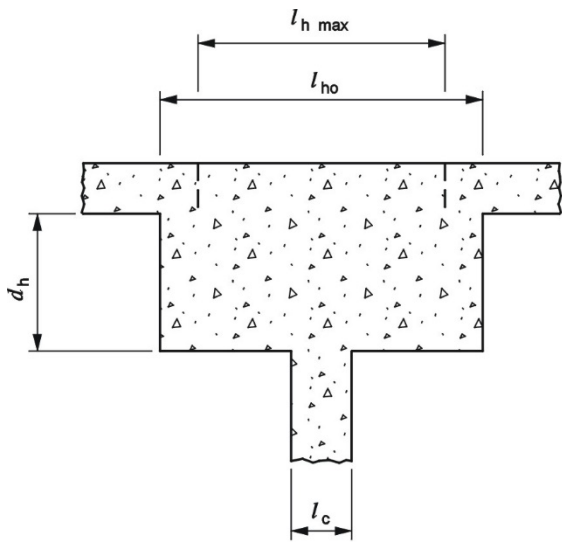

i) $l_h = l_{h \text{ max}}$

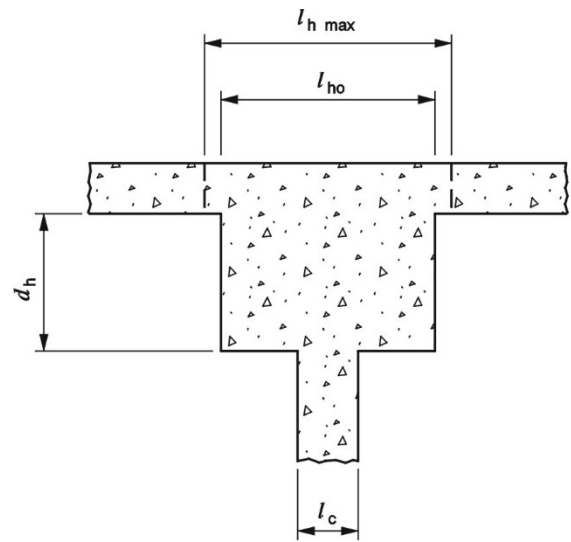

ii) $l_h = l_{ho}$

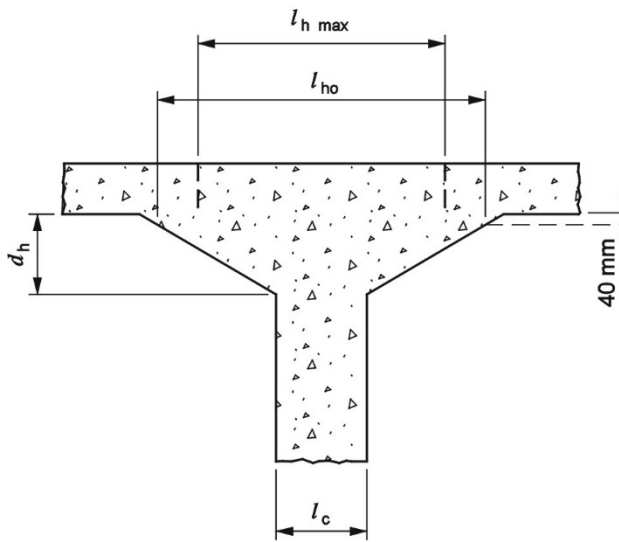

iii) $l_h = l_{h \text{ max}}$

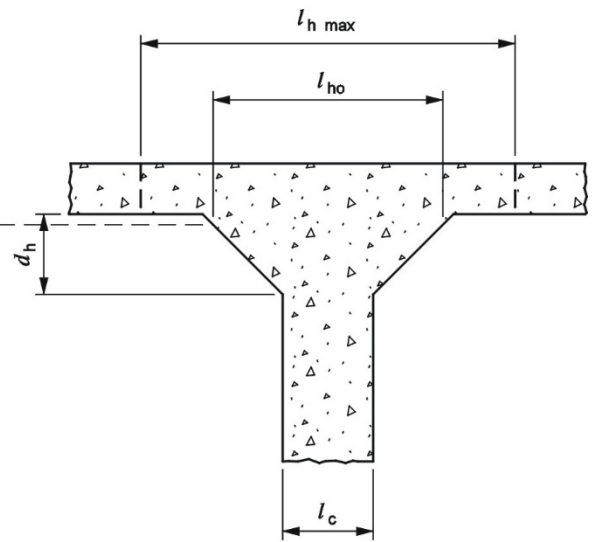

iv) $l_h = l_{ho}$

Figure 6.8 - Types of column head

6.1.5.2 Analysis of flat slab structures

(a) General

While, in principle, a flat slab should be analysed to obtain at each section the moments and shears resulting from the most unfavourable arrangement of the design loads, it will normally be satisfactory to obtain the moments and forces within a system of flat slab panels from analysis of the structure under the single load case of maximum design load on all spans or panels simultaneously, provided the conditions set out in clause 6.1.3.2 (c) are satisfied.

Where it is not appropriate to analyse for the single load case of maximum design load on all spans, it will be sufficient to consider the arrangements of load given in clause 5.2.5.2.

(b) Analysis

In the absence of a more rigorous treatment, flat slabs consisting of a series of rectangular panels may be divided into a series of frames and analysed in accordance with clause 6.1.5.2 (c) to (j).

(c) Division of flat slab structures into frames

The structures may be divided longitudinally and transversely into frames consisting of columns and strips of slab. The width of slab used to define the effective stiffness of the slab will depend upon the aspect ratio of the panels and type of loading. In the case of vertical loading, the stiffness of rectangular panels may be calculated taking into account the full width of the panel. For horizontal loading, it will be more appropriate to take half this value.

(d) Frame analysis methods

Each frame may be analysed in its entirety by the Hardy Cross method or other suitable elastic methods. Alternatively, for vertical loads only, each strip of floor and roof may be analysed as a separate frame with the columns above and below fixed in position and direction at their extremities or the simplified sub-frame described in clause 5.2.5.3 may be used. In either case, the analysis should be carried out for the appropriate design ultimate loads on each span calculated for a strip of slab of width equal to the distance between centre lines of the panels on each side of the columns.

(e) Frame stiffness

The second moment of area of any section of slab or column used in calculating the relative stiffness of members may be assumed to be that of the cross-section of the concrete alone.

(f) Limitation of negative design moments

Negative moments greater than those at a distance $h_c/2$ from the centre-line of the column may be ignored providing the absolute sum of the maximum positive design moment and the average of the negative design moments in any one span of the slab for the whole panel width is not less than:

$$\frac{nl_2}{8} \left(l_1 - \frac{2h_c}{3} \right)^2 \quad 6.38$$

where:

- h_c is the effective diameter of a column or column head,
- n is the design ultimate load per unit area,
- l used in Table 6.4 should be taken as the full panel length in the direction of span,
- l_1 is the panel length parallel to span, measured from centres of columns,
- l_2 is the panel width, measured from centres of columns l_h .

When the above condition is not satisfied, the negative design moments should be increased.

(g) Simplified method for determining moments

For flat-slab structures whose lateral stability is not dependent on slab-column connections, Table 6.4 may be used subject to the following provisions:

- (i) design is based on the single load case of all spans loaded with the maximum design ultimate load, (i.e. the conditions of clause 6.1.3.2 (c) are satisfied);

- (ii) there are at least three rows of panels of approximately equal span in the direction being considered;
 - (iii) moments at supports taken from Table 6.4 may be reduced by $0.15Fh_c$ where F is the total design ultimate load on the full width of panel between adjacent bay centre lines; and
 - (iv) the limitation of clause 6.1.5.2 (f) need not be checked. Allowance has been made to the coefficients of Table 6.4 for 20% redistribution in accordance with clause 6.1.3.2 (c).
- (h) Division of panels (except in the region of edge and corner columns)
- Flat slab panels should be assumed to be divided into column strips and middle strips (see Figure 6.9). In the assessment of the widths of the column and middle strips, drops should be ignored if their smaller dimension is less than one-third of the smaller dimension of the panel.
- (i) Column strips between unlike panels
- Where there is a support common to two panels of such dimensions that the strips in one panel do not match those in the other, the division of the panels over the region of the common support should be taken as that calculated for the panel giving the wider column strip.
- (j) Division of moments between column and middle strips
- The design moments obtained from analysis of the continuous frames or from Table 6.4 should be divided between the column and middle strips in the proportions given in Table 6.10.

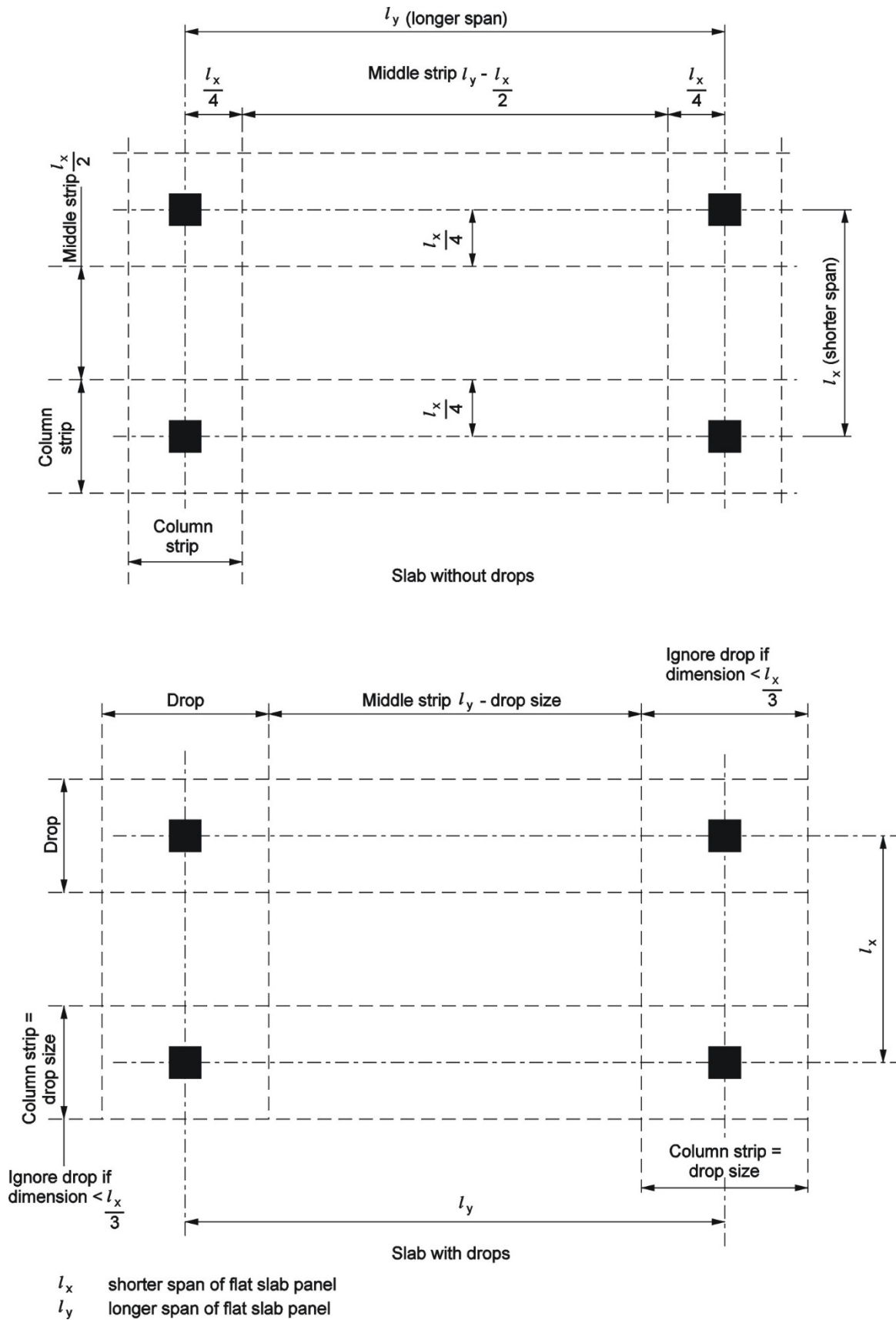

Figure 6.9 - Division of panels in flat slabs

| Design moment | Apportionment between column and middle strip expressed as percentages of the total negative or positive design moment | |
|---------------|--|------------------|
| | Column strip (%) | Middle strip (%) |
| Negative | 75 | 25 |
| Positive | 55 | 45 |

Note:

- For the case where the width of the column strip is taken as equal to that of the drop, and the middle strip is thereby increased in width, the design moments to be resisted by the middle strip should be increased in proportion to its increased width. The design moments to be resisted by the column strip may be decreased by an amount such that the total positive and the total negative design moments resisted by the column strip and middle strip together are unchanged.

Table 6.10 - Division of design moments in panels of flat slabs

6.1.5.3 Design of internal panels

(a) Column and middle strips

The column and middle strips should be designed to withstand the design moments obtained from clause 6.1.5.2. In general, two-thirds of the amount of reinforcement required to resist the negative design moment in the column strip should be placed in a width equal to half that of the column strip and central with the column.

(b) Curtailment of bars

Curtailment of bars should be in accordance with clause 9.3.1.2.

6.1.5.4 Design of edge panels

(a) Positive design moments in span and negative design moments over interior edges

These design moments should be apportioned and designed exactly as for an internal panel, using the same column and middle strips as for an internal panel.

(b) Design moments transferable between slab and edge or corner columns

In general, moments will only be able to be transferred between a slab and an edge or corner column by a column strip considerably narrower than that appropriate for an internal panel. The breadth of this strip, b_e , for various typical cases is shown in Figure 6.10. The value of b_e should never be taken as greater than the column strip width appropriate for an interior panel.

The maximum design moment $M_{t \max}$ which can be transferred to a column by this strip is given by:

$$M_{t \max} = 0.15b_e d^2 f_{cu} \quad 6.39$$

where:

d is the effective depth for the top reinforcement in the column strip.

$M_{t \max}$ should be not less than half the design moment obtained from an equivalent frame analysis or 70% of the design moment if a grillage or finite element analysis has been used. If $M_{t \max}$ is calculated to be less than this, the structural arrangements should be changed.

(c) Limitation of moment transfer

Where analysis of the structure indicates a design column moment larger than $M_{t \max}$, the design edge moment in the slab should be reduced to a value not greater than $M_{t \max}$ and the positive design moments in the span adjusted accordingly. The normal limitations on redistributions and neutral axis depth may be disregarded in this case. Moments in excess of $M_{t \max}$ may only be transferred to a column if an edge beam or strip of slab along the free edge

is reinforced in accordance with clause 6.3 to carry the extra moment into the column by torsion. In the absence of an edge beam, an appropriate breadth of slab may be assessed by using the principles illustrated in Figure 6.10.

(d) Negative moments at free edge

Reinforcement for negative design moments (other than in the column strip) is only needed where moments arise from loading on any extension of the slab beyond the column centre-lines. However, top reinforcement at least equal to the minimum reinforcement defined in clause 9.3.1 should be provided, extending at least $0.15l$ or an anchorage length, whichever is the greater, into the span.

(e) Panels with marginal beams or walls

Where the slab is supported by a marginal beam with a depth greater than 1.5 times the thickness of the slab, or by a wall then:

- (i) the total design load to be carried by the beam or wall should comprise those loads directly on the wall or beams plus a uniformly distributed load equal to one-quarter of the total design load on the panel; and
- (ii) the design moments of the half-column strip adjacent to the beams or wall should be one-quarter of the design moments obtained from clause 6.1.5.2.

6.1.5.5 Openings in panels

(a) General

Except for openings conforming to clause 6.1.5.5 (b) to (d), openings should be completely framed on all sides with beams to carry the loads to the columns. No opening should encroach upon a column head.

(b) Holes in areas bounded by column strips

Holes in areas bounded by column strips may be formed providing:

- (i) that their greatest dimension in a direction parallel to a centre-line of the panel does not exceed $0.4l$; and
- (ii) that the total positive and negative design moments given in clause 6.1.5.2 are redistributed between the remaining structure to meet the changed conditions.

(c) Holes in areas common to two column strips

Holes in areas common to two column strips may be formed providing:

- (i) that in aggregate their length or width does not exceed one-tenth of the width of the column strip;
- (ii) that the reduced sections are capable of resisting the appropriate moments given in clause 6.1.5.2; and
- (iii) that the perimeter for calculating the design shear stress is reduced if appropriate.

(d) Holes in areas common to a column strip and middle strip

Holes in areas common to a column strip and a middle strip may be formed providing:

- (i) that in aggregate their length or width does not exceed one-quarter of the width of the column strip; and
- (ii) that the reduced sections are capable of resisting the appropriate design moments given in clause 6.1.5.2.

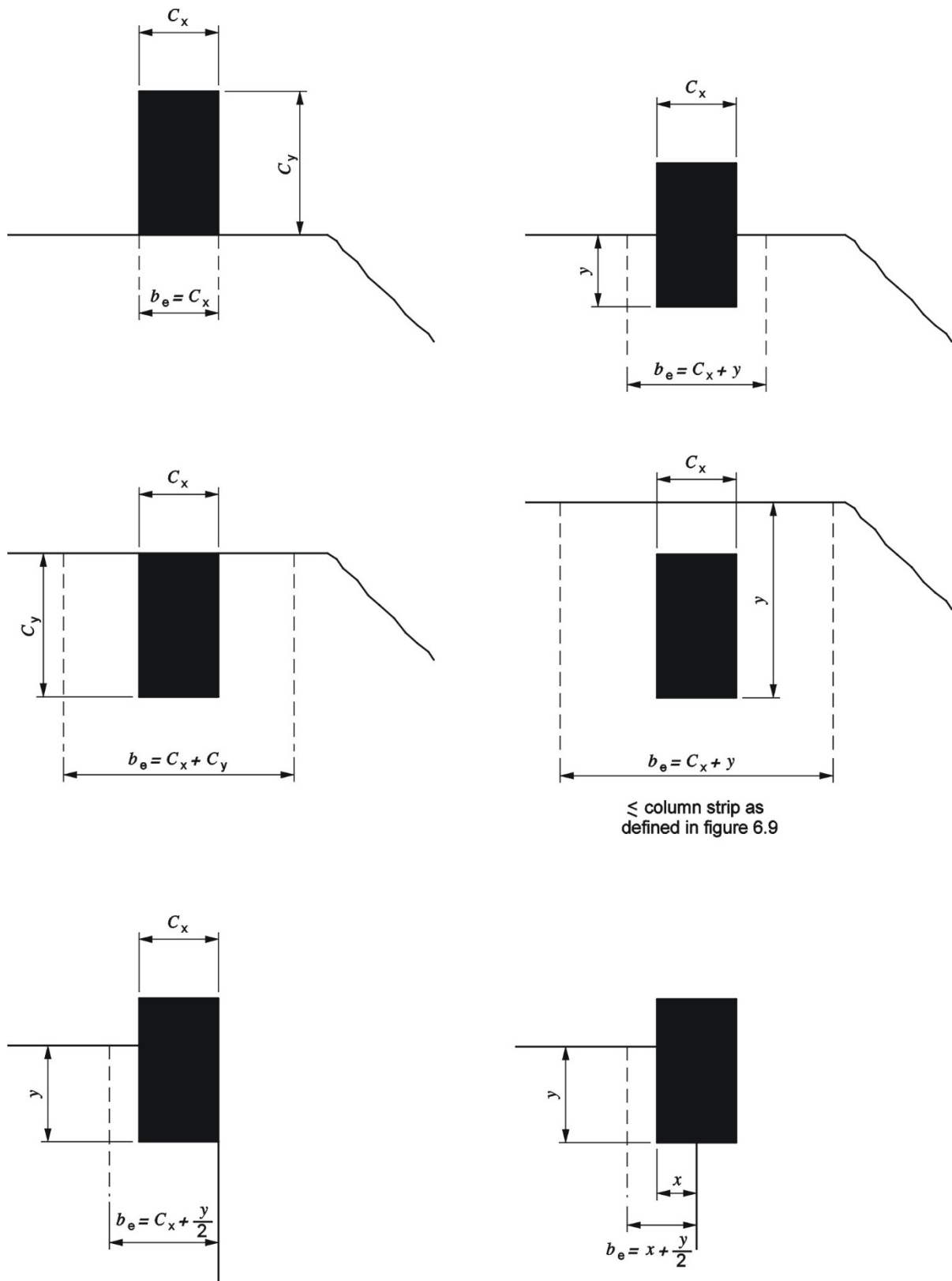

- Notes : 1. y is the distance from the face of the slab to the innermost face of the column.
 2. C_x and C_y are plan dimensions of column.

Figure 6.10 - Definition of breadth of effective moment transfer strip b_e for various typical cases

6.1.5.6 Effective shear forces in flat slabs

(a) General

The critical consideration for shear in flat slab structures is that of punching shear around the columns. This is checked in accordance with the provisions of clause 6.1.5.7 except that the shear stresses are increased as stated in clause 6.1.5.6(b) and clause 6.1.5.6 (c) to allow for the effects of moment transfer.

Figure 6.11 and Figure 6.12 are intended to clarify the application of these sub clauses.

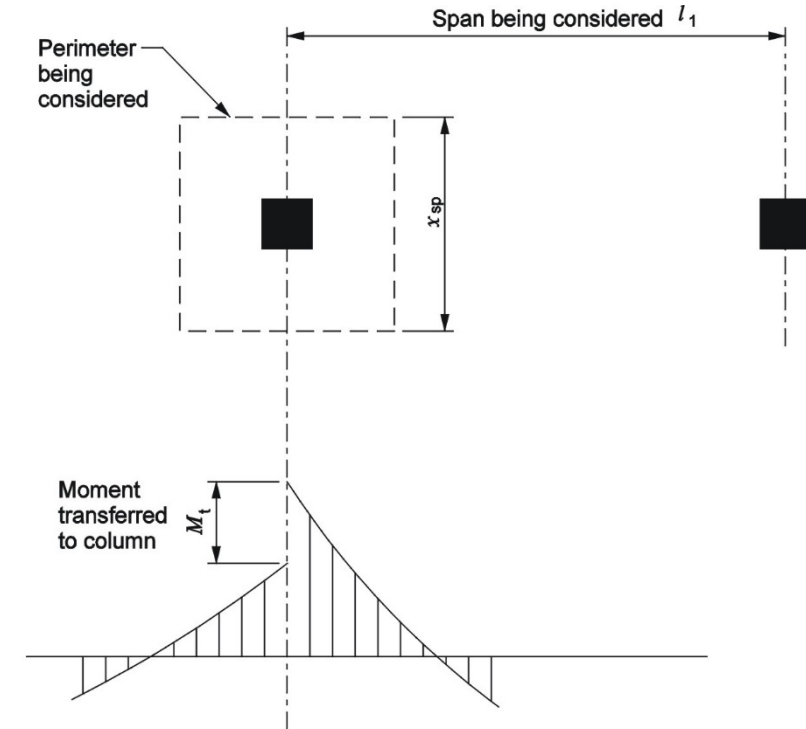

a) Bending moments diagram for load case being considered

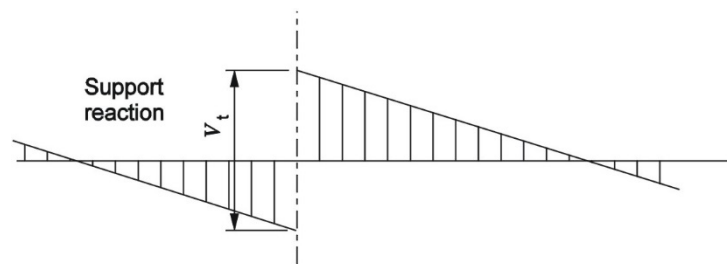

b) Shear force diagram for load case being considered

Figure 6.11 - Shear at slab column junctions

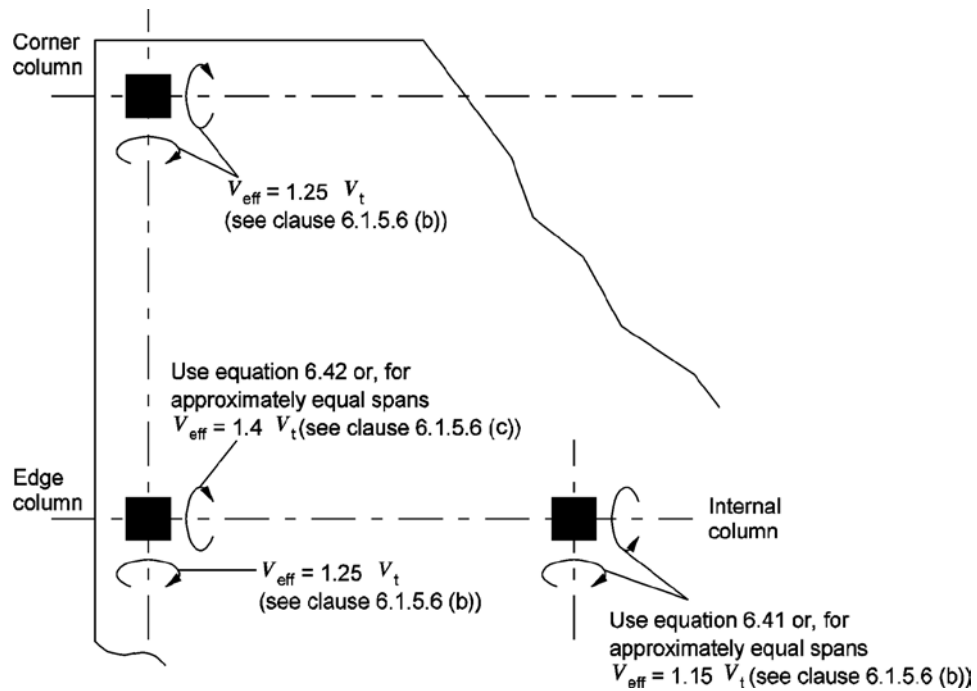

Figure 6.12 - Application of clauses 6.1.5.6 (b) and (c)

(b) Shear stress at slab/internal column connections in flat slabs

After calculation of the design moment transmitted by the connection (in accordance with clause 6.1.5.2) the design effective shear force at the perimeter V_{eff} should be taken as:

$$V_{\text{eff}} = V_t \left(1 + \frac{1.5M_t}{V_t x_{\text{sp}}} \right) \quad 6.40$$

where:

x_{sp} is the length of the side of the shear perimeter considered parallel to the axis of bending,

M_t is the design moment transmitted from the slab to the column at the connection,

V_t is the design shear transferred to column,

V_{eff} design effective shear including allowance for moment transfer.

In the absence of calculation, it will be satisfactory to take a value of $V_{\text{eff}} = 1.15V_t$ for internal columns in braced structures with approximately equal spans; where V_t is calculated on the assumption that the maximum design load is applied to all panels adjacent to the column considered.

Note 1: Equation 6.40 should be applied independently for the moments and shears about both axes of the column and the design checked for the worst case.

Note 2: M_t may be reduced by 30% where the equivalent frame method has been used and analysis has been based on pattern loads.

(c) Shear stress at other slab-column connections

At corner columns and at edge columns where bending about an axis parallel to the free edge is being considered, the design effective shear is calculated from $V_{\text{eff}} = 1.25V_t$. For edge columns where bending about an axis perpendicular to the edge is being considered, the design effective shear should be calculated using equation 6.41:

$$V_{\text{eff}} = V_t \left(1.25 + \frac{1.5M_t}{V_t x_{\text{sp}}} \right) \quad 6.41$$

Alternatively, V_{eff} may be taken as $1.4V_t$ for approximately equal spans.

Note: M_t may be reduced by 30% where the equivalent frame method has been used and analysis has been based on patterned loads.

(d) Maximum design shear stress at the column face

The maximum design shear stress at the column face should not exceed $0.8\sqrt{f_{\text{cu}}}$ or 7.0 N/mm^2 , whichever is the lesser, when assessed using equation 6.40 or 6.41, as appropriate, on a perimeter equal to the perimeter of the column or column head (this includes an allowance for γ_m of 1.25).

6.1.5.7 Shear under concentrated loads

(a) Mode of punching failure

Punching failures occur on the inclined faces of truncated cones or pyramids, depending on the shape of the loaded areas. However, for practical purposes, it is satisfactory to consider rectangular failure perimeters. Empirical methods of designing against punching shear failure are given in clause 6.1.5.7 (b) to (h).

(b) Maximum design shear capacity

The maximum design shear stress v_{max} should not exceed $0.8\sqrt{f_{\text{cu}}}$ or 7.0 N/mm^2 if less. The value of v_{max} is given by the equation:

$$v_{\text{max}} = \frac{V}{u_o d} \quad 6.42$$

where:

V is the design ultimate value of the concentrated load,

u_o is the effective length of the perimeter which touches a loaded area.

The maximum shear capacity may also be limited by the provisions of clause 6.1.5.7 (e).

(c) Calculation of design shear stress

The nominal design shear stress v appropriate to a particular perimeter is calculated from the following equation:

$$v = \frac{V}{ud} \quad 6.43$$

where:

u is the effective length of the outer perimeter of the zone.

(d) Shear capacity without shear reinforcement

Provided the shear stress v is less than v_c obtained from Table 6.3 no shear reinforcement is required. The enhancement of v_c permitted in clause 6.1.2.5 (g) may not be applied to the shear strength of perimeters at a distance of $1.5d$ or more from the face of the loaded area. Where it is desired to check perimeters closer to the loaded area than $1.5d$, v_c may be increased by a factor $1.5d/a_v$ where a_v is the distance from the edge of the loaded area to the perimeter considered.

(e) Provision for shear reinforcement

The use of shear reinforcement other than links is not covered specifically by this code and should be justified separately.

If $v_c < v < 2 v_c$, shear reinforcement in the form of links may be provided in accordance with equations 6.44 and 6.45 in slabs over 200 mm deep to increase the shear resistance.

For cases where $v \leq 1.6 v_c$ shear reinforcement should be provided in accordance with the following equation:

$$\sum A_{sv} \sin \alpha \geq \frac{(v - v_c)ud}{0.87 f_{yv}} \quad 6.44$$

where:

f_{yv} is the characteristic strength of shear reinforcement (in N/mm²),

ΣA_{sv} is the area of shear reinforcement (in mm²),

α is the angle between the shear reinforcement and the plane of the slab.

For cases where $1.6 v_c < v \leq 2 v_c$, shear reinforcement should be provided in accordance with:

$$\sum A_{sv} \sin \alpha \geq \frac{5(0.7v - v_c)ud}{0.87 f_{yv}} \quad 6.45$$

Equations 6.44 and 6.45 should not be applied where the shear stress v exceeds $2 v_c$.

Where $v > 2 v_c$ and a reinforcing system is provided to increase the shear resistance, justification should be provided to demonstrate the validity of the design.

When using equations 6.44 and 6.45, $\Sigma A_{sv} \sin \alpha$ should not be taken as less than $v_r u d / 0.87 f_{yv}$, where v_r is defined in Table 6.2.

(f) Design procedure

The shear capacity is checked first on a perimeter $1.5d$ from the face of the loaded area. If the calculated shear stress does not exceed v_c then no further checks are needed.

If shear reinforcement is required, then it should be provided on at least two perimeters within the zone indicated in Figure 6.13. The first perimeter of reinforcement should be located at approximately $0.5d$ from the face of the loaded area and should contain not less than 40% of the calculated area of reinforcement.

The spacing of perimeters of reinforcement should not exceed $0.75d$ and the spacing of the shear reinforcement around any perimeter should not exceed $1.5d$. The shear reinforcement should be anchored round at least one layer of tension reinforcement. The shear stress should then be checked on successive perimeters at $0.75d$ intervals until a perimeter is reached which does not require shear reinforcement.

In providing reinforcement for the shear calculated on the second and subsequent perimeters, that provided for the shear on previous perimeters and which lies within the zone shown in Figure 6.13 should be taken into account.

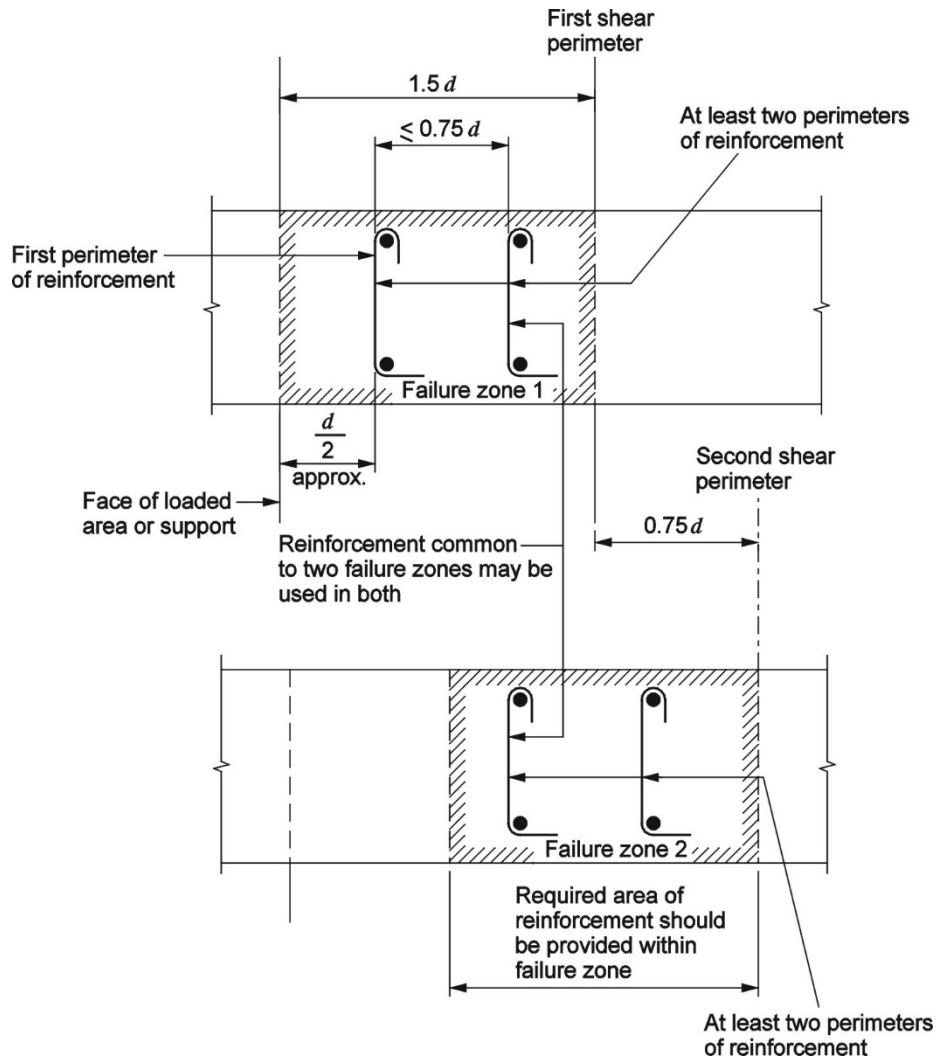

Figure 6.13 - Zones for punching shear reinforcement

(g) Modification of effective perimeter to allow for holes

When openings in slabs and footings (see Figure 6.14) are located at a distance less than six times the effective depth of the slab from the edge of a concentrated load, then that part of the perimeter which is enclosed by radial projections from the centroid of the loaded area to the openings is considered ineffective.

Where a single hole is adjacent to the column and its greatest width is less than one-quarter of the column side or one-half of the slab depth, whichever is the lesser, its presence may be ignored.

(h) Effective perimeter close to a free edge

Where a concentrated load is located close to a free edge, the effective length of a perimeter should be taken as the lesser of the two illustrated in Figure 6.15. The same principle may be adopted for corner columns.

6.1.5.8 Design of columns in flat slab construction

Columns should be designed in accordance with the provisions of clause 6.2.1.

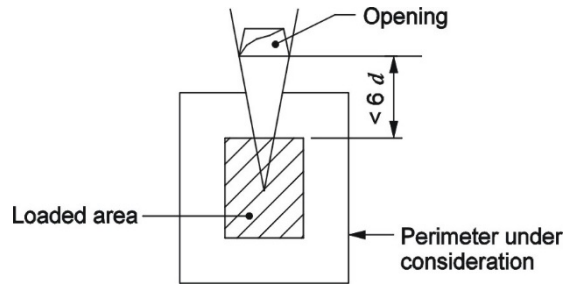

Figure 6.14 - Shear perimeter of slabs with openings

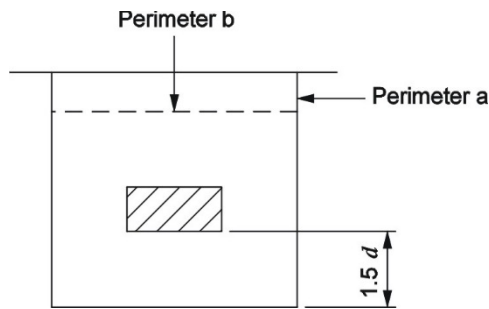

Figure 6.15 - Shear perimeters with loads close to free edge

6.2 MEMBERS AXIALLY LOADED WITH OR WITHOUT FLEXURE

6.2.1 Columns

6.2.1.1 General

(a) Size of columns

The size of a column and the position of the reinforcement in it may be affected by the requirements for durability and fire resistance, and these should be considered before the design is commenced.

(b) Short and slender columns

A column may be considered as short when both ratios l_{ex}/h and l_{ey}/b are less than 15 (braced) and 10 (unbraced), where:

l_{ex} effective height in respect of the major axis,

l_{ey} effective height in respect of the minor axis,

b width of a column (dimension of cross-section perpendicular to h),

h is the depth of cross-section measured in the plane under consideration.

It should otherwise be considered as slender.

(c) Plain concrete columns

If a column has a large enough section to resist the ultimate loads without the addition of reinforcement, then it may be designed similarly to a plain concrete wall (see clause 6.2.2.3).

(d) Braced and unbraced columns

A column may be considered braced in a given plane if lateral stability to the structure as a whole is provided by walls or bracing or buttressing designed to resist all lateral forces in that plane. It should otherwise be considered as unbraced.

(e) Effective height of a column

(i) General

The effective height, l_e , of a column in a given plane may be obtained from the following equation:

$$l_e = \beta l_0 \quad 6.46$$

where:

l_0 is the clear height between end restraints.

Values of β are given in Table 6.11 and Table 6.12 for braced and unbraced columns respectively as a function of the end conditions of the column. It should be noted that the effective height of a column in the two plan directions may be different.

In Table 6.11 and Table 6.12 the end conditions are defined in terms of a scale from 1 to 4. Increase in this scale corresponds to a decrease in end fixity. An appropriate value can be assessed from clause 6.2.1.1(e)(ii) below.

| End condition at top | End condition at bottom | | |
|----------------------|-------------------------|------|------|
| | 1 | 2 | 3 |
| 1 | 0.75 | 0.80 | 0.90 |
| 2 | 0.80 | 0.85 | 0.95 |
| 3 | 0.90 | 0.95 | 1.00 |

Table 6.11 - Values of β for braced columns

| End condition at top | End condition at bottom | | |
|----------------------|-------------------------|-----|-----|
| | 1 | 2 | 3 |
| 1 | 1.2 | 1.3 | 1.6 |
| 2 | 1.3 | 1.5 | 1.8 |
| 3 | 1.6 | 1.8 | - |
| 4 | 2.2 | - | - |

Table 6.12 - Values of β for unbraced columns

(ii) End conditions

The four end conditions are as follows:

Condition 1. The end of the column is connected monolithically to beams on either side which are at least as deep as the overall dimension of the column in the plane considered. Where the column is connected to a foundation structure, this should be of a form specifically designed to carry moment.

Condition 2. The end of the column is connected monolithically to beams or slabs on either side which are shallower than the overall dimension of the column in the plane considered.

Condition 3. The end of the column is connected to members which, while not specifically designed to provide restraint to rotation of the column will, nevertheless, provide some nominal restraint.

Condition 4. The end of the column is unrestrained against both lateral movement and rotation (e.g. the free end of a cantilever column in an unbraced structure).

(f) Slenderness limits for columns

Generally, the clear distance, l_0 , between end restraints should not exceed 60 times the minimum thickness of a column.

(g) Slenderness of unbraced columns

If, in any given plane, one end of an unbraced column is unrestrained (e.g. a cantilever column), its clear height, l_o , should satisfy the following:

$$l_o = \frac{100b^2}{h} \leq 60b \quad 6.47$$

Note: In equation 6.47 h and b are respectively the larger and smaller dimensions of the column.

The considerations of deflection (see clause 7.3) may introduce further limitations.

6.2.1.2 *Moments and forces in columns*

(a) Columns in monolithic frames designed to resist lateral forces

In such cases the moments, shear forces and axial forces should be determined in accordance with clause 5.2.6 (see also clause 6.2.1.2 (b)).

(b) Additional moments induced by deflection at ULS

In slender columns additional moments induced by deflection at ULS should also be considered. An allowance for them is made in the design requirements for slender columns (see clause 6.2.1.3). The bases or other members connected to the ends of such columns should also be designed to resist these additional moments at ULS if the average value of l_e/h for all columns at a particular level is greater than 20. Clause 6.2.1.3 (i) gives guidance in the design for these moments.

(c) Columns in column-and-beam construction, or in monolithic braced structural frames

The axial force in a column may be calculated on the assumption that beams and slabs transmitting force into it are simply supported.

When a column is subject only to an axial load with no significant applied moment, as in the case of columns supporting a symmetrical arrangement of approximately equally loaded beams, only the design ultimate axial force need be considered in design together with a design moment representing a nominal allowance for eccentricity, equal to that recommended in clause 6.2.1.2 (d).

(d) Minimum eccentricity

At no section in a column should the design moment be taken as less than that produced by considering the design ultimate axial load as acting at a minimum eccentricity, e_{\min} , equal to 0.05 times the overall dimension of the column in the plane of bending considered but not more than 20 mm. Where biaxial bending is considered, it is only necessary to ensure that the eccentricity exceeds the minimum about one axis at a time.

6.2.1.3 *Deflection induced moments in solid slender columns*

(a) Design

In general, a cross-section may be designed by the methods given for a short column (see clause 6.2.1.4) but in the design, account has to be taken of the additional moment induced in the column by its deflection.

The deflection of a rectangular or circular column under ultimate conditions may be taken to be:

$$a_u = \beta_a Kh \quad 6.48$$

In this expression β_a has the value obtained from Table 6.13 or, alternatively, from equation 6.51 from which the table is derived, where K is a reduction factor that corrects the deflection to allow for the influence of axial load. K is derived from the following equation:

$$K = \frac{N_{uz} - N}{N_{uz} - N_{bal}} \leq 1 \quad 6.49$$

where:

N is the design ultimate axial load on a column.

N_{bal} is the design axial load capacity of a balanced section; for symmetrically-reinforced rectangular sections, it may be taken as $0.25f_{cu}bd$.

N_{uz} is the design ultimate capacity of a section when subjected to axial load only (see equation 6.50).

and:

$$N_{uz} = 0.45f_{cu}A_{nc} + 0.87f_yA_{sc} \quad (\text{including allowances, as appropriate for } \gamma_m). \quad 6.50$$

where:

A_{nc} is the net cross-sectional area of concrete in a column,

A_{sc} is the area of vertical reinforcement.

The appropriate values of K may be found iteratively, taking an initial value of 1. Alternatively, it will always be conservative to assume that $K = 1$.

| | | | | | | | | | | | |
|-----------|------|------|------|------|------|------|------|------|------|------|------|
| l_e/b | 12 | 15 | 20 | 25 | 30 | 35 | 40 | 45 | 50 | 55 | 60 |
| β_a | 0.07 | 0.11 | 0.20 | 0.31 | 0.45 | 0.61 | 0.80 | 1.01 | 1.25 | 1.51 | 1.80 |

Table 6.13 - Values of β_a

Table 6.13 is derived from the following equation:

$$\beta_a = \frac{1}{2000} \left(\frac{l_e}{b} \right)^2 \quad 6.51$$

Note: b is generally the smaller dimension of the column (but see clause 6.2.1.3 (f) for biaxial bending).

The deflection induces an additional moment given by:

$$M_{add} = Na_u \quad 6.52$$

where:

a_u is the deflection at ULS for each column calculated from equation 6.48.

M_{add} is the additional design ultimate moment induced by deflection of column.

(b) Design moments in braced columns bent about a single axis

Figure 6.16 shows the distribution of moments assumed over the height of a typical braced column. It may be assumed that the initial moment at the point of maximum additional moment (i.e. near mid-height of the column) is given by:

$$M_i = 0.4M_1 + 0.6M_2 \geq 0.4M_2 \quad 6.53$$

where

M_1 is the smaller initial end moment due to design ultimate loads,

M_2 is the larger initial end moment due to design ultimate loads,

M_i is the initial design ultimate moment in a column before allowance for additional design moments arising out of slenderness.

Assuming the column is bent in double curvature, M_1 should be taken as negative and M_2 positive.

It will be seen from Figure 6.16 that the maximum design moment for the column will be the greatest of the following:

M_2 ;

$M_i + M_{add}$;

$M_1 + M_{add}/2$; or

$e_{min}N$.

- (c) Slender columns bent about a single axis (major or minor)
Provided the ratio of the length of the longer side to that of the shorter side is less than three and that, for columns bent about their major axis, l_e/h does not exceed 20, the additional moment may be calculated using equations 6.48 to 6.53 and added to the appropriate initial moments to obtain the total design moment. The initial moment M_1 is the maximum moment at the critical section calculated for the ultimate limit state.
- (d) Columns where l_e/h exceeds 20, bent about their major axis
In these cases the section should be designed as biaxially bent, with zero initial moment about the minor axis.
- (e) Columns bent about their major axis
Where the ratio of the longer to the shorter side equals three or more, the section should be designed as biaxially bent with zero initial moment about the minor axis.
- (f) Slender columns bent about both axes
Where the bending is significant about both axes, additional moments are calculated from equations 6.48 to 6.52 for both directions of bending. For each direction, b in Table 6.13 should be taken as h , the dimension of the column in the plane of bending considered. These additional moments are then combined with the appropriate initial moments to obtain total design moments in the two directions. The critical section is then designed to withstand the design ultimate axial load, N , plus the total design moments in the two directions.

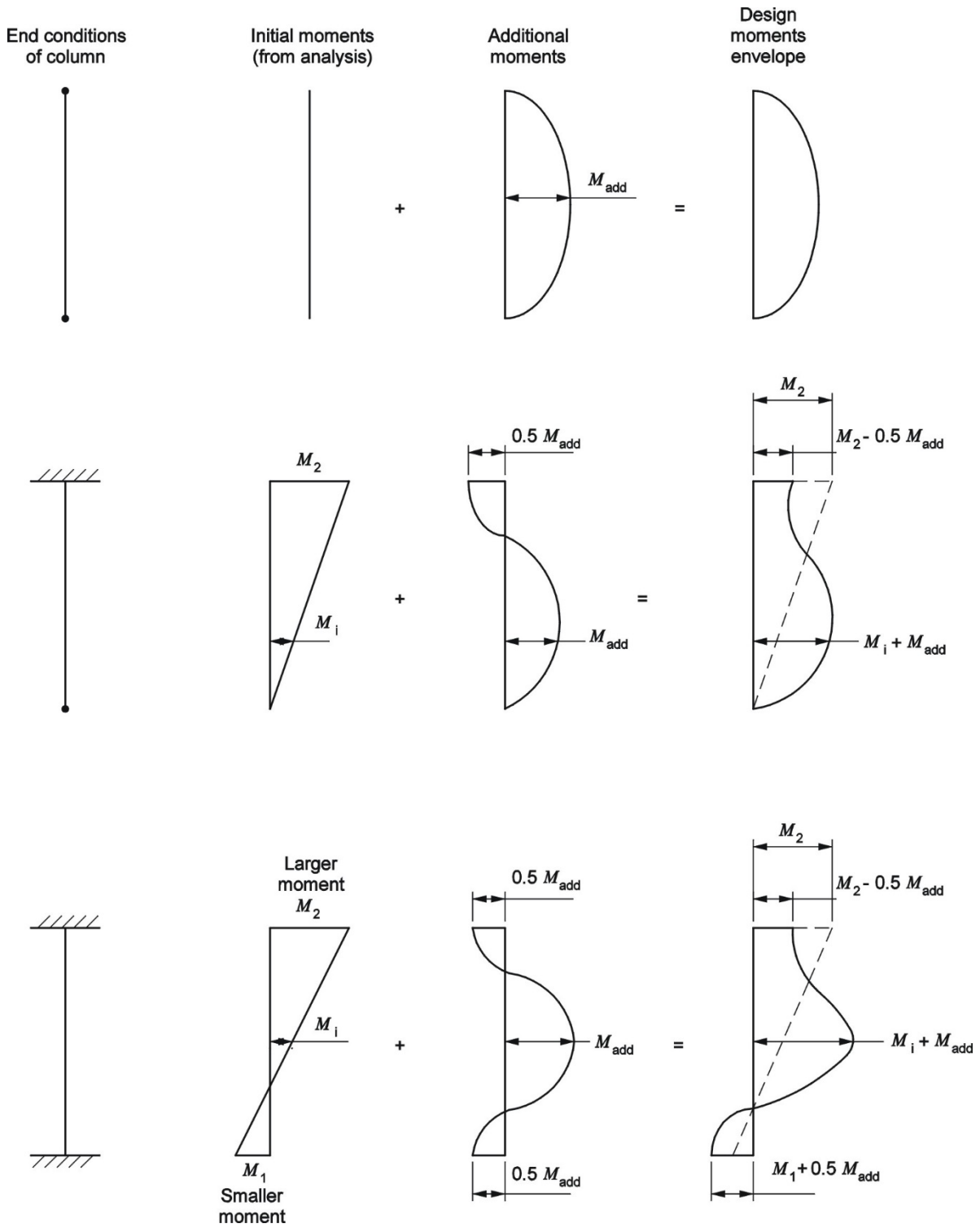

Figure 6.16 - Braced slender columns

(g) Unbraced structures

The distribution of moments assumed over the height of an unbraced column is indicated in Figure 6.17. The additional moment referred to in clause 6.2.1.3 (a) may be assumed to occur at whichever end of the column has the stiffer joint; the additional moment at the other end may be reduced in proportion to the ratio of the joint stiffnesses at either end. The moment will act in a direction such that it increases the absolute magnitude at the critical section.

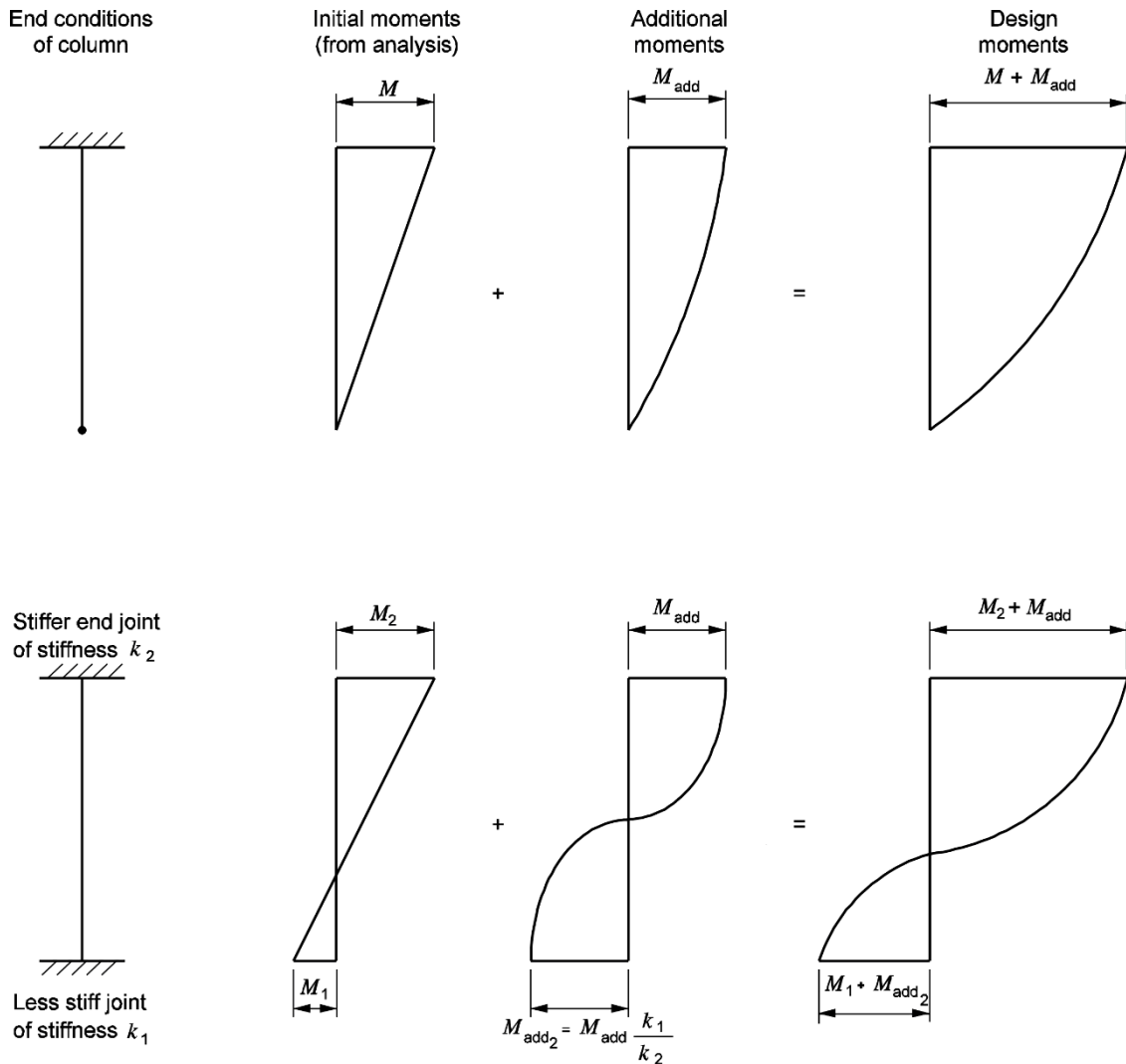

Figure 6.17 - Unbraced slender columns

(h) Deflection of unbraced columns

At any given level or storey all unbraced columns subject to lateral load are usually constrained to deflect sideways by the same amount. In such cases, an average ultimate deflection, a_{UAV} , may be applied to all the columns at a given level. This deflection can be assessed from the following equation:

$$a_{UAV} = \frac{\sum a_U}{n} \tag{6.54}$$

where n is the number of columns resisting sideways at a given level or storey.

After the calculation of a_{UAV} any values of a_U more than twice a_{UAV} should be ignored and the average recalculated; in this case n in equation 6.54 should be reduced appropriately.

- (i) Additional moments on members attached to a slender column

Where l_e/h exceeds 20 and either one or both ends of the column are connected monolithically to other members (e.g. a base, slabs or beams) then these members could be designed to withstand the additional design moments applied by the ends of the column in addition to those calculated using normal analytical methods. Where there are columns both above and below a joint, the beams or slabs should be designed to withstand the sum of the additional design moments at the ends of the two columns.

6.2.1.4 Design of column section for ULS

- (a) Analysis of sections

In the analysis of a column cross-section to determine its design ultimate resistance to moment and axial force, the same assumptions should be made as when analysing a beam (see clause 6.1.2.4 (a)).

- (b) Nominal eccentricity of short columns resisting moments and axial forces

Short columns usually need only to be designed for the maximum design moment about the one critical axis.

Where, due to the nature of the structure, a column cannot be subjected to significant moments, it may be designed so that the design ultimate axial load does not exceed the value of N given by:

$$N = 0.4f_{cu}A_c + 0.75A_{sc}f_y \quad 6.55$$

Note: This includes an allowance for γ_m

- (c) Short braced columns supporting an approximately symmetrical arrangement of beams

The design ultimate axial load for a short column of this type may be calculated using the following equation:

$$N = 0.35f_{cu}A_c + 0.67A_{sc}f_y \quad 6.56$$

where:

- (i) the beams are designed for uniformly distributed imposed loads; and
- (ii) the beam spans do not differ by more than 15% of the longer.

Note: This includes an allowance for γ_m .

- (d) Biaxial bending

When it is necessary to consider biaxial bending and in the absence of more rigorous calculations in accordance with clause 6.1.2.4 (a), symmetrically-reinforced rectangular sections may be designed to withstand an increased moment about one axis given by the following equations:

$$\text{for } \frac{M_x}{h'} \geq \frac{M_y}{b'}, M_x' = M_x + \beta \frac{h'}{b'} M_y \quad 6.57$$

$$\text{for } \frac{M_x}{h'} < \frac{M_y}{b'}, M_y' = M_y + \beta \frac{b'}{h'} M_x \quad 6.58$$

where:

- M_x is the design ultimate moment about the x-axis.
- M_x' is the effective uniaxial design ultimate moment about the x-axis.
- M_y is the design ultimate moment about the y-axis
- M_y' is the effective uniaxial design ultimate moment about the y-axis.
- h' and b' are shown in Figure 6.18;
- β is the coefficient obtained from Table 6.14

(e) Shear in columns

(i) Design concrete shear stress

The design shear strength of columns should be checked in accordance with clause 6.1.2.5(k).

(ii) Design shear resistance of rectangular column

For rectangular sections in compression no check is required provided that M/N does not exceed $0.6h$ and v does not exceed the maximum value given in clause 6.1.2.5(k). Otherwise, shear resistance of rectangular column should be checked in accordance with clause 6.1.2.5.

| $N/(bhf_{cu})$ | 0 | 0.1 | 0.2 | 0.3 | 0.4 | 0.5 | ≥ 0.6 |
|----------------|------|------|------|------|------|------|------------|
| β | 1.00 | 0.88 | 0.77 | 0.65 | 0.53 | 0.42 | 0.30 |

Table 6.14 - Values of the coefficient β

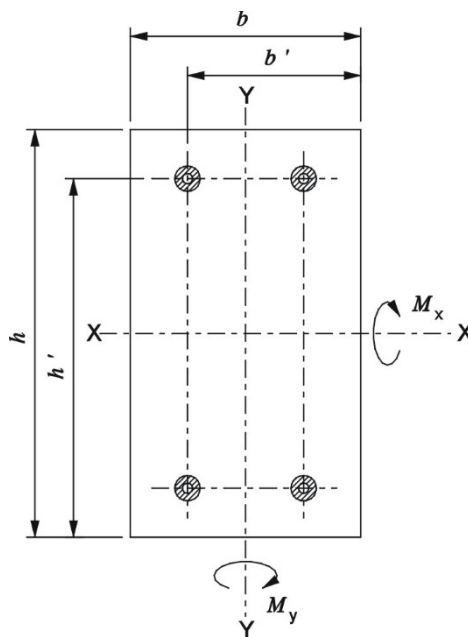

Figure 6.18 - Biaxially bent columns

(iii) Design shear resistance of circular column

Shear resistance of circular column should be checked in accordance with clause 6.1.2.5 with the following definitions.

(1) For equation 6.19, $bvd = r^2 (\pi/2 + \alpha + \sin \alpha \cos \alpha)$ 6.58a
 where:

r is the radius of the circular section

r_s is the radius of the circumference along the centre line of the longitudinal reinforcement (see Figure 6.18a)

$d = r(1 + \sin \alpha)$ is the effective depth taken as the depth to the centroid of the reinforcement below the centre line of the cross section of the circular column (see Figure 6.18a)

$\sin \alpha = 2r_s / (\pi r)$ ($0 < \alpha < \pi/2$)

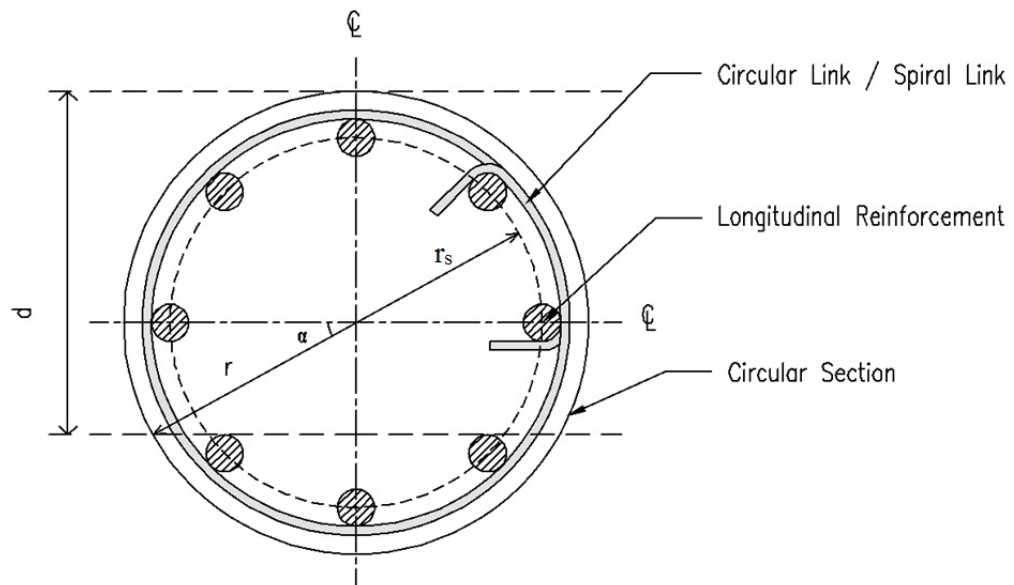

Figure 6.18a - Geometry of the Circular Section

- (2) For Table 6.2, the term $(v_c + v_r)$ should be replaced by v_c such that nominal links should be provided when $0.5v_c < v < v_c$ and shear reinforcement should be provided when $v_c < v < 0.8\sqrt{f_{cu}}$ or 7.0 N/mm^2 ;
- (3) For Table 6.3, calculation of v_c , A_s should be taken as half the total area of longitudinal steel and $b_v d$ should be determined as equation 6.58a.

(iv) Provision of shear reinforcement

Shear reinforcement can be either fixed with circular links (see equation 6.58b) or spiral links (see equation 6.58c). The spacing of links is in the direction of the height of the circular columns. The shear design for the cross section should be analysed from the following equations:

$$A_{sv} \geq \frac{2r s_v (v - v_c)}{0.87 f_{yv}} \quad 6.58b$$

or

$$A_{sv} \geq \frac{r s_v (v - v_c)}{0.87 f_{yv} (1 - 0.225 s_v / r)} \quad 6.58c$$

where:

s_v is the spacing of circular links along the member for equation 6.58b or the pitch spacing of spiral links along the member for equation 6.58c

Note: Since each link is cut twice by the shear plane, A_{sv} is twice the cross sectional area of the link.

6.2.2 Walls

6.2.2.1 Structural stability

(a) Overall stability

The elements of construction providing lateral stability to the structure as a whole need not be designed to support the forces referred to in clause 6.2.2.1 (c) in addition to the other design loads and forces.

(b) Overall stability of multi-storey buildings

The overall stability of multi-storey buildings should not, in any direction, depend on unbraced walls alone.

(c) Forces in lateral supports

The supports should be able to transmit forces assumed equal in magnitude to the sum of the following:

- (i) the simple static reactions to the sum of the applied design ultimate horizontal forces at the point of lateral support; and
- (ii) 2.5% of the total design ultimate vertical load that the wall or column is designed to carry at the point of lateral support.

(d) Resistance to rotation of lateral supports

This resistance should only be considered to exist:

- (i) where both the lateral support and the braced wall are concrete walls adequately detailed to provide bending restraint; or
- (ii) where precast or insitu concrete floors (irrespective of the direction of span) have a bearing on at least two-thirds of the thickness of the wall, or where there is a connection providing adequate bending restraint.

6.2.2.2 Design for reinforced walls

(a) Axial forces

The design axial force in a reinforced wall may be calculated on the assumption that the beams and slabs transmitting force into it are simply supported.

(b) Effective height

(i) General

For a reinforced wall that is constructed monolithically with the adjacent construction, l_e should be assessed as though the wall were a column subject to bending at right angles to the plane of the wall, following the procedure given in clause 6.2.1 for columns.

(ii) Simply-supported construction

Where the construction transmitting load to a reinforced wall is, or is assumed to be, simply supported, the effective height should be assessed as for a plain wall.

(c) Design transverse moments

Design transverse moments, when derived from beams or other construction designed to frame monolithically at right angles into the walls, should be calculated using elastic analysis. When construction is designed to be simply supported by the wall, the eccentricity may be assessed as for plain walls (see clause 6.2.2.3) and the resultant moment calculated. Except for short braced walls loaded almost symmetrically, the eccentricity in the direction at right angles to a wall should be taken as not less than $h/20$, or 20 mm if less, where h is the thickness of the wall.

(d) In-plane moments

Design moments in the plane of a single wall due to horizontal forces may be calculated from statics alone.

When a horizontal force is resisted by several walls, the proportion allocated to each wall should be in proportion to its relative stiffness. When a shear connection is assumed between vertical edges of adjacent walls, an appropriate elastic analysis may be used provided the shear connection is designed to withstand the design forces.

(e) Arrangement of reinforcement for reinforced walls in tension

In any part of a reinforced wall where tension develops under the design ultimate loads, the reinforcement should be arranged in two layers and each layer should be in accordance with the bar spacing rules given in clauses 8.2 and 9.6.

(f) Stocky reinforced walls

(i) Stocky braced walls supporting approximately symmetrical arrangements of slabs

A wall of this type may be designed in such a way that:

$$n_w \leq 0.35 f_{cu} A_c + 0.67 A_{sc} f_y \quad 6.59$$

where:

n_w is the total design axial load on the wall due to design ultimate loads; provided the slabs are designed for a uniformly distributed imposed load and the spans on either side of the wall do not differ by more than 15%.

Note: Allowance for γ_m is included in this equation.

(ii) Walls resisting transverse moments and uniformly distributed axial forces

When the only eccentricity of force derives from the transverse moments, the design axial load may be assumed to be distributed uniformly along the length of the wall. The cross-section of the wall should be designed to resist the appropriate design ultimate axial load and transverse moment. The assumptions made in the analysis of beam sections apply (see clause 6.1.2.4 (a)).

(iii) Walls resisting in-plane moments and axial forces

The cross-section of the wall should be designed to resist the appropriate design ultimate axial load and in-plane moments.

(iv) Walls with axial forces and significant transverse and in-plane moments

The effects should be assessed in three stages as follows.

- (1) In-plane. Considering only axial forces and in-plane moments, the distribution of force along the wall is calculated by elastic analysis, assuming no tension in the concrete (see clause 6.2.2.2 (d)).
- (2) Transverse. The transverse moments are calculated (see clause 6.2.2.2 (c)).
- (3) Combined. At various points along the wall, the in-plane and transverse effects are combined and checked using the assumptions of 6.1.2.4(a).

(g) Slender reinforced walls

(i) Design procedure

The effects should be assessed in stages as follows.

- (1) In-plane. Considering only axial forces and in-plane moments the distribution of force along the wall is calculated by elastic analysis, assuming no tension in the concrete (see clause 6.2.2.2 (d)).
- (2) Transverse. The transverse moments are calculated (see clause 6.2.2.2 (c) and clause 6.2.2.2 (g) (iii)).
- (3) Combined. The in-plane and transverse effects are combined and each unit length is considered as a slender column and designed as such in accordance with clause 6.2.1.4.

(ii) Limits of slenderness

The slenderness ratio l_e/h should not exceed that given in Table 6.15 for the reinforcement provided.

| Wall condition | Reinforcement | Maximum value of l_e/h |
|----------------|---------------------------------------|--------------------------|
| Braced | As given in clause 9.6 but < 1% | 40 |
| Braced | As given in clause 9.6 but $\geq 1\%$ | 45 |
| Unbraced | As given in clause 9.6 | 30 |

Table 6.15 - Maximum slenderness ratios for reinforced walls

(iii) Transverse moments

In such walls significant moments additional to those mentioned in clause 6.2.2.2 (c) may be induced by lateral deflection under load. Appropriate allowance for this is made by considering such walls as slender columns bent about the minor axis (see clause 6.2.1.3 (a)), except that where a wall is reinforced with only one central layer of reinforcement the additional moments should be doubled.

6.2.2.3 Design of plain walls

(a) Axial forces

The design ultimate axial force in a plain wall may be calculated on the assumption that the beams and slabs transmitting forces into it are simply supported.

(b) Effective height of unbraced plain concrete walls

The effective height of unbraced plain concrete walls is given as follows:

- (i) wall supporting at its top a roof or floor slab spanning at right angles: $l_e = 1.5 l_o$, where l_o is the clear height of wall between lateral support;
- (ii) other walls $l_e = 2 l_o$.

Note: For gable walls to pitched roofs, l_o may be measured mid-ways between eaves and ridge.

(c) Effective height of braced plain walls

The effective height of braced plain walls is given as follows:

- (i) where any lateral support resists both rotation and lateral movement, l_e equals three-quarters of the clear distance between lateral supports or twice the distance between a support and a free edge as appropriate;
- (ii) where any lateral support resists only lateral movement, l_e equals the distance between centres of support, or two and a half times the distance between a support and a free edge, as appropriate.

(d) Limits of slenderness

The slenderness ratio l_e/h should not exceed 30 whether the wall is braced or unbraced.

(e) Minimum transverse eccentricity of forces

Whatever the arrangements of vertical or horizontal forces, the resultant force in every plain wall should be assumed to have a transverse eccentricity of not less than $h/20$ or 20 mm. In the case of a slender wall further eccentricity can arise as a result of deflection under load. Procedures allowing for this are given in clause 6.2.2.3 (p) and (q).

(f) In-plane eccentricity due to forces on a single wall

In-plane eccentricity due to forces on a single wall may be calculated by statics alone.

(g) In-plane eccentricity due to horizontal forces on two or more parallel walls

Where a horizontal force is resisted by several walls, it should be assumed to be shared between the walls in proportion to their relative stiffnesses provided the resultant eccentricity in any individual wall is not greater than one-third of the length of the wall. Where the eccentricity in any wall is found to be greater than this, the wall's stiffness should be considered as zero and an adjustment made to the forces assumed carried by the remainder.

(h) Panels with shear connections

Where, in a wall, a shear connection is assumed between vertical edges of adjacent panels, an appropriate elastic analysis may be made provided the shear connection is designed to resist the design ultimate forces.

(i) Eccentricity of loads from concrete floor or roof

The design loads may be assumed to act at one-third the depth of the bearing area from the loaded face. Where there is an insitu concrete floor on either side of the wall, the common bearing area may be assumed to be shared equally on each floor.

(j) Other eccentricity-applied loads

It should be noted that loads may be applied to walls at eccentricities greater than half the thickness of the wall through special fittings (e.g. joist hangers).

(k) In-plane and transverse eccentricity of resultant force on an unbraced wall

At any level full allowance should be made for the eccentricity of all vertical loads and the overturning moments produced by any lateral forces above that level.

(l) Transverse eccentricity of resultant force on a braced wall

At any level the transverse eccentricity with respect to the wall's axial plane may be calculated on the assumption that immediately above a lateral support the resultant eccentricity of all the vertical loads above that level is zero.

(m) Concentrated loads

When these are purely local (as at beam bearings or column bases) these may be assumed to be immediately dispersed provided the local design stress under the load does not exceed $0.6f_{cu}$ for concrete grade 25 or above, or $0.5f_{cu}$ for lower-strength concrete.

(n) Calculation of design load per unit length

Design load per unit length should be assessed on the basis of a linear distribution of load along the length of the wall, with no allowance for any tensile strength.

(o) Maximum unit axial loads for stocky braced plain walls

The maximum design ultimate axial load per unit length of wall due to ultimate loads, n_w , should satisfy the following:

$$n_w \leq 0.3(h - 2e_x)f_{cu} \quad 6.60$$

where:

e_x is the resultant eccentricity of load at right angles to the plane of the wall (with minimum value $h/20$).

(p) Maximum design ultimate axial load for slender braced plain walls

The maximum design ultimate axial load n_w should satisfy equation 6.60 and the following:

$$n_w \leq 0.3(h - 1.2e_x - 2e_a)f_{cu} \quad 6.61$$

where:

e_x is as defined in clause 6.2.2.3 (o);

e_a is the additional eccentricity due to deflections which may be taken as $l_e^2/2500h$, where l_e is the effective height of the wall.

(q) Maximum unit axial load for unbraced plain walls

The maximum unit axial load for unbraced plain walls should satisfy the following:

$$(i) \quad n_w \leq 0.3(h - 2e_{x,1})f_{cu} \quad 6.62$$

$$(ii) \quad n_w \leq 0.3[h - 2(e_{x,2} + e_a)]f_{cu} \quad 6.63$$

where:

e_a is defined in clause 6.2.2.3(p);

$e_{x,1}$ is the resultant eccentricity calculated at the top of a wall;

$e_{x,2}$ is the resultant eccentricity calculated at the bottom of a wall.

(r) Shear strength

The design shear resistance of plain walls need not be checked if one of the following conditions is satisfied:

- (i) horizontal design shear force is less than one-quarter of design vertical load; or
- (ii) horizontal design shear force is less than that required to produce an average design shear stress of 0.45 N/mm² over the whole wall cross-section.

Note: For concrete of grade lower than 25, the figure of 0.3 N/mm² should be used instead of 0.45 N/mm²

(s) Reinforcement around openings in plain walls

Nominal reinforcement should be considered.

(t) Reinforcement of plain walls for flexure

If, at any level, a length of wall greater than one-tenth of the total length is subjected to tensile stress, resulting from in-plane eccentricity of the resultant force, vertical reinforcement to distribute potential cracking may be necessary. It needs to be provided only in the area of wall found to be in tension under design service loads. It should be arranged in two layers and conform to the spacing rules given in clauses 8.2 and 9.6.

6.3 TORSION AND COMBINED EFFECTS

6.3.1 General

In normal slab-and-beam or framed construction specific calculations are not usually necessary, torsional cracking being adequately controlled by shear reinforcement. However, when the design relies on the torsional resistance of a member, the recommendations given in clause 6.3.2 to 6.3.9 should be taken into account.

6.3.2 Calculation of torsional rigidity

If required in structural analysis or design, the torsional rigidity ($G \times C$) may be calculated by assuming the shear modulus G equal to 0.42 times the modulus of elasticity of the concrete and assuming the torsional constant C equal to half the St. Venant value calculated for the plain concrete section.

The torsional constant of a rectangular section may be calculated from equation 6.64:

$$C = \frac{1}{2} \beta h_{\min}^3 h_{\max} \quad 6.64$$

where:

C is the torsional constant (equals half the St. Venant value for the plain concrete section),

h_{\max} is the larger dimension of a rectangular section,

h_{\min} is the smaller dimension of a rectangular section.

β is a coefficient depending on the ratio h/b (overall depth of member divided by the breadth).

Note: Values of β are given in Table 6.16.

| h_{\max}/h_{\min} | 1 | 1.5 | 2 | 3 | 5 | >5 |
|---------------------|------|------|------|------|------|------|
| β | 0.14 | 0.20 | 0.23 | 0.26 | 0.29 | 0.33 |

Table 6.16 - Values of coefficient β

The St. Venant torsional stiffness of a non-rectangular section may be obtained by dividing the section into a series of rectangles and summing the torsional stiffness of these rectangles. The division of the section should be arranged so as to maximise the calculated stiffness. This will generally be achieved if the widest rectangle is made as long as possible.

6.3.3 Torsional shear stress

(a) Rectangular sections

The torsional shear stress v_t at any section should be calculated assuming a plastic stress distribution and may be calculated from equation 6.65:

$$v_t = \frac{2T}{h_{\min}^2 \left(h_{\max} - \frac{h_{\min}}{3} \right)} \quad 6.65$$

where:

T is the torsional moment due to ultimate loads,
 v_t is the torsional shear stress.

(b) T, L or I sections

T, L or I sections are divided into their component rectangles; these are chosen in such a way as to maximise $h_{\min}^3 h_{\max}$ in the following expression.

The torsional shear stress v_t carried by each of these component rectangles may be calculated by treating them as rectangular sections subjected to a torsional moment of:

$$T \times \left(\frac{h_{\min}^3 h_{\max}}{\sum (h_{\min}^3 h_{\max})} \right) \quad 6.66$$

(c) Hollow sections

Box and other hollow sections in which wall thicknesses exceed one-quarter of the overall thickness of the member in the direction of measurement may be treated as solid rectangular sections.

Note: For other sections, specialist literature should be consulted.

6.3.4 Limit to shear stress

In no case should the sum of the shear stresses resulting from shear force and torsion ($v + v_t$) exceed the maximum combined shear stress (shear plus torsion) v_{tu} in Table 6.17 nor, in the case of small sections where $y_1 < 550$ mm, should the torsional shear stress v_t exceed $v_{tu} y_1 / 550$ (see definition of y_1 in clause 6.3.6).

| Concrete grade | $v_t \text{ min}$ (N/mm ²) | v_{tu} (N/mm ²) |
|----------------|---|----------------------------------|
| 25 | 0.33 | 4.00 |
| 30 | 0.37 | 4.38 |
| 40 | 0.40 | 5.00 |
| 50 | 0.47 | 5.65 |
| 60 | 0.52 | 6.20 |
| 80 or above | 0.60 | 7.0 |

Notes:

1. Allowance is made for γ_m .

2. $v_t \text{ min}$ is the minimum torsional shear stress, above which reinforcement is required.

Values of $v_t \text{ min}$ and v_{tu} (in N/mm²) are derived from the equations:

$$v_t \text{ min} = 0.067 \sqrt{f_{cu}} \text{ but not more than } 0.6 \text{ N/mm}^2;$$

$$v_{tu} = 0.8 \sqrt{f_{cu}} \text{ but not more than } 7.0 \text{ N/mm}^2$$

Table 6.17 - Values of $v_t \text{ min}$ and v_{tu}

6.3.5 Reinforcement for torsion

Where the torsion shear stress v_t exceeds minimum torsional shear stress $v_t \text{ min}$ in Table 6.17, reinforcement should be provided. Recommendations for reinforcement for combinations of shear and torsion are given in Table 6.18.

| | $v_t \leq v_{t \text{ min}}$ | $v_t > v_{t \text{ min}}$ |
|--------------------|--|--|
| $v \leq v_c + v_f$ | Minimum shear reinforcement; no torsion reinforcement | Designed torsion reinforcement but not less than the minimum shear reinforcement |
| $v > v_c + v_f$ | Designed shear reinforcement; no torsion reinforcement | Designed shear and torsion reinforcement |

Notes: v_f is defined in Table 6.2.

Table 6.18 - Reinforcement for shear and torsion

6.3.6 Area of torsional reinforcement

Torsion reinforcement should consist of rectangular closed links together with longitudinal reinforcement. This reinforcement is additional to any requirements for shear or bending and should be such that:

$$\frac{A_{sv}}{s_v} > \frac{T}{0.8x_1y_1(0.87f_{yv})} \quad 6.67$$

$$A_s > \frac{A_{sv}f_{yv}(x_1 + y_1)}{s_vf_y} \quad 6.68$$

where:

A_s is the area of longitudinal reinforcement,

A_{sv} is the area of two legs of closed links at a section (only legs lying closest to the outside of section should be considered),

s_v is the spacing of the links,

x_1 is the smaller centre-to-centre dimension of a rectangular link,

y_1 is the larger centre-to-centre dimension of a rectangular link.

Note: f_y and f_{yv} should not be taken as greater than 500 N/mm².

6.3.7 Spacing and type of links

The value s_v should not exceed the least of x_1 , $y_1/2$ or 200 mm. The links should be a closed shaped link in accordance with clause 9.2.3.

6.3.8 Arrangement of longitudinal reinforcement

Longitudinal torsion reinforcement should be distributed evenly round the inside perimeter of the links. The clear distance between these bars should not exceed 300 mm and at least four bars, one in each corner of the links, should be used. Additional longitudinal reinforcement required at the level of the tension or compression reinforcement may be provided by using larger bars than those required for bending alone. The torsion reinforcement should extend a distance at least equal to the largest dimension of the section beyond where it theoretically ceases to be required.

6.3.9 Arrangement of links in T, L or I sections

In the component rectangles, the reinforcement cages should be detailed so that they interlock and tie the component rectangles of the section together. Where the torsional shear stress in a minor component rectangle does not exceed $v_{t \text{ min}}$, no torsion reinforcement need be provided in that rectangle.

6.4 DESIGN FOR ROBUSTNESS AGAINST DISPROPORTIONATE COLLAPSE

6.4.1 Design of Ties

6.4.1.1 General

The necessary interaction between elements is obtained by tying the structure together using the following types of tie (see clause 2.2.2.3):

- (a) peripheral ties;
- (b) internal ties;
- (c) horizontal ties to columns and walls;
- (d) vertical ties.

Where a building is divided by expansion joints into structurally independent sections, each section should have an appropriate tying system.

6.4.1.2 Proportioning of ties

In the design of the ties, the reinforcement may be assumed to be acting at its characteristic strength (i.e. with a γ_m of 1.0) and forces other than those given in clause 6.4.1.4 to 6.4.1.7 may be neglected. Reinforcement provided for other purposes may be regarded as forming part of, or the whole of, these ties.

6.4.1.3 Continuity and anchorage of ties

Bars should be lapped, welded or mechanically joined in accordance with clause 8.7.

A tie may be considered anchored to another tie at right angles if the bars of the former tie extend:

- (a) 12 x bar diameter or an equivalent anchorage beyond all the bars of the other tie; or
- (b) an effective anchorage length (based on the force in the bars) beyond the centre-line of the bars of the other tie.

At re-entrant corners or at substantial changes in construction, care should be taken to ensure that the ties are adequately anchored or otherwise made effective.

6.4.1.4 Internal ties

- (a) Distribution and location

These ties should be at each floor and roof level in two directions approximately at right angles. They should be effectively continuous throughout their length and should be anchored to the peripheral ties at each end (unless continuing as horizontal ties to columns or walls). They may, in whole or in part, be spread evenly in the slabs or may be grouped at or in beams, walls or other appropriate positions, but at spacings generally not greater than $1.5 l_f$ where l_f is the greater of the distances (in metres) between the centres of the columns, frames or walls supporting any two adjacent floor spans in the direction of the tie under consideration. In walls they should be within 0.5 m of the top or bottom of floor slabs.

- (b) Strength

In each direction, the ties should be capable of resisting a tensile force (in kN/m width) equal to the greater of:

$$\frac{(G_k + Q_k) l_f}{7.5} F_t \text{ or } 1.0 F_t \quad 6.69$$

where:

$(G_k + Q_k)$ is the sum of the average characteristic dead and imposed floor loads (in kN/m²);

F_t is the lesser of $(20 + 4n_o)$ or 60, where n_o is the number of storeys in the structure;

l_f is as defined in clause 6.4.1.4(a).

Whenever walls occur in plan in one direction only (e.g. "cross wall" or "spine wall" construction) the value of l_f used when assessing the tie force in the direction parallel to the wall should be taken as either the actual length of the wall or the length which may be considered lost in the event of an accident, whichever is the lesser. The length which may be considered lost should be taken as the length between adjacent lateral supports or between a lateral support and a free edge. Further information is given in clause 6.4.2.2 (b).

6.4.1.5 *Peripheral ties*

At each floor and roof level an effectively continuous peripheral tie should be provided, capable of resisting a tensile force (in kN) of $1.0F_t$, located within 1.2 m of the edge of the building or within the perimeter wall.

6.4.1.6 *Horizontal ties to columns and walls*

(a) General

Each external column and, if the peripheral tie is not located within the wall, every metre length of external wall carrying vertical load should be anchored or tied horizontally into the structure at each floor and roof level with a tie capable of developing a force (in kN) equal to the greater of:

- (i) $2.0 F_t$ or $(l_s/2.5) F_t$ if less, where l_s is the floor to ceiling height (in m); or
- (ii) 3% of the total design ultimate vertical load carried by the column or wall at that level.

Where the peripheral tie is located within the wall, only such horizontal tying as is required to anchor the internal ties to the peripheral ties needs to be provided (see clauses 6.4.1.4 (a) and 6.4.1.4 (b)).

(b) Corner column ties

Corner columns should be tied into the structure at each floor and roof level in each of two directions, approximately at right angles, with ties each capable of developing a force equal to the greater of the values obtained from clause 6.4.1.6 (a).

6.4.1.7 *Vertical ties*

Each column and each wall carrying vertical load should be tied continuously from the lowest to the highest level. The tie should be capable of resisting a tensile force equal to the maximum design ultimate dead and imposed load received by the column or wall from any one storey. The design load is that assessed in accordance with clauses 2.3.1.5 and 2.3.2.2. Where a column or a wall at its lowest level is supported by an element other than a foundation, a general check for structural integrity should be made in accordance with clause 2.2.2.3.

6.4.2 **Bridging elements**

6.4.2.1 *General*

At each storey in turn, each vertical load-bearing element, other than a key element, is considered lost in turn. The design should be such that collapse of a significant part of the structure does not result. If catenary action is assumed, allowance should be made for the horizontal reactions necessary for equilibrium.

6.4.2.2 *Walls*

(a) Length considered lost

The length of wall considered to be a single load-bearing element should be taken as the length between adjacent lateral supports or between a lateral support and a free edge see clause (b).

(b) Lateral support

For the purposes of this subclause, a lateral support may be considered to occur at:

- (i) a stiffened section of the wall (not exceeding 1.0 m in length) capable of resisting a horizontal force (in kN per metre height of the wall) of $1.5F_t$; or
- (ii) a partition of mass not less than 100 kg/m^2 at right angles to the wall and so tied to it as to be able to resist a horizontal force (in kN per metre height of wall) of $0.5F_t$;

where:

F_t is the lesser of $(20 + 4n_0)$ or 60, where n_0 is the number of storeys in the structure.

6.5 CORBELS AND NIBS

6.5.1 General

A corbel is a short cantilever projection which supports a load-bearing member and where:

- (a) the distance a_v between the line of the reaction to the supported load and the root of the corbel is less than d (the effective depth of the root of the corbel); and
- (b) the depth at the outer edge of the contact area of the supported load is not less than one-half of the depth at the root of the corbel.

The depth of the corbel at the face of the support is determined from shear conditions in accordance with clause 6.1.2.5 (g) but using the modified definition of a_v given above.

6.5.2 Design

6.5.2.1 Simplifying assumptions

The concrete and reinforcement may be assumed to act as elements of a simple strut-and-tie system, with the following guidelines.

- (a) the corbel should be designed at the ultimate limit state using the appropriate partial safety factors on the reinforcement and concrete, but the magnitude of the resistance provided to horizontal force should be not less than one-half of the design vertical load on the corbel (see also clause 6.5.2.4).
- (b) compatibility of strains between the strut-and-tie at the corbel root should be ensured.

It should be noted that the horizontal link requirement described in clause 6.5.2.3 will ensure satisfactory serviceability performance.

6.5.2.2 Reinforcement anchorage

At the front face of the corbel, the reinforcement should be anchored either by:

- (a) welding to a transverse bar of equal strength; in this case the bearing area of the load should stop short of the transverse bar by a distance equal to the cover of the tie reinforcement; or
- (b) by bending back the bars to form a loop; in this case the bearing area of the load should not project beyond the straight portion of the bars forming the main tension reinforcement.

6.5.2.3 Shear reinforcement

Shear reinforcement should be provided in the form of horizontal links distributed in the upper two-thirds of the effective depth of root of the corbel; this reinforcement should be not less than one-half of the area of the main tension reinforcement and should be adequately anchored.

6.5.2.4 Resistance to applied horizontal force

Additional reinforcement connected to the supported member should be provided to transmit this force in its entirety.

6.5.3 Continuous concrete nibs

6.5.3.1 General

Where a continuous nib is less than 300 mm deep, it should normally be designed as a short cantilever slab, where:

- (a) the line of action of design load is assumed to occur at the outer edge of the loaded area, e.g. at the front edge of a nib without a chamfer, at the upper edge of a chamfer or at outer edge of a bearing pad; and
- (b) the maximum design ultimate bending moment is the distance from the line of action of the load to the nearest vertical leg of the links in the beam member from which the nib projects times the load (see clause 6.5.3.5).

6.5.3.2 Areas of tension reinforcement

The area of tension reinforcement should be not less than that given in clause 9.8.

6.5.3.3 Position of tension reinforcement

The position of tension reinforcement should project from the supporting member across the top of the nib to a point as near to the front face of the nib as considerations of adequate cover will allow. It

should be anchored in this position either by welding to a transverse bar of equal strength or by bending the bars through 180° to form loops in the horizontal or vertical plane. Vertical loops should be of bar diameter not greater than 12 mm.

6.5.3.4 *Design shear resistance*

The design shear resistance should be checked in accordance with 6.1.3.6 except that the values of v_c given in Table 6.3 may be multiplied by $2d/a_v$, where a_v is taken as the distance described in clause 6.5.3.1.

6.5.3.5 *Links in members from which the nib projects*

Links should be provided which, in addition to any other forces they may be required to resist, are capable of transmitting the load from the nib to the compression zone of the member.

6.6 STAIRCASES

6.6.1 Loading

6.6.1.1 *Distribution of loading*

In general, the design ultimate load should be assumed to be uniformly distributed over the plan area of a staircase. When, however, staircases surrounding open wells include two spans that intersect at right angles, the load on the areas common to both spans may be assumed to be divided equally between the two spans.

When staircases or landings that span in the direction of the flight are built at least 110 mm into walls along part or all of their length, a 150 mm strip adjacent to the wall may be deducted from the loaded area.

6.6.1.2 *Effective span of monolithic staircases without stringer beams*

When the staircase is built monolithically at its ends into structural members spanning at right angles to its span, the effective span should be as given in equation 6.70:

$$\text{effective span} = l_a + 0.5(l_{b,1} + l_{b,2}) \quad 6.70$$

where

l_a is the clear horizontal distance between the supporting members;

$l_{b,1}$ is the breadth of the supporting member at one end or 1.8 m, whichever is the lesser,

$l_{b,2}$ is the breadth of the supporting member at the other end or 1.8 m, whichever is the lesser.

6.6.1.3 *Effective span of simply supported staircases without stringer beams*

The effective span of simply-supported staircases without stringer beams should be taken as the horizontal distance between the centre-lines of the supports or the clear distance between the faces of supports plus the effective depth, whichever is the lesser.

6.6.1.4 *Depth of section*

The depth of the section should be taken as the minimum thickness perpendicular to the soffit of the staircase.

6.6.2 Design of staircases

The recommendations for beams and slabs given in clause 6.1.2 and 6.1.3 apply except for the span/depth ratio of a staircase without stringer beams where clause 6.6.2.1 applies.

6.6.2.1 *Permissible span/effective depth ratio for staircases without stringer beams*

Provided the stair flight occupies at least 60% of the span, the ratio calculated in accordance with clause 7.3.4 may be increased by 15%.

6.7 FOUNDATIONS

6.7.1 Assumptions in the design of pad footings and pile caps

6.7.1.1 General

Except where the reactions to the applied loads and moments are derived by more accurate methods, e.g. an elastic analysis of a pile group or the application of established principles of soil mechanics, the following assumptions could be made if a base or a pile cap is considered to be of sufficient rigidity.

- (a) when a base or a pile cap is axially loaded, the reactions to design ultimate loads may be assumed to be uniformly distributed (i.e. load per unit area or per pile).
- (b) when a base or a pile cap is eccentrically loaded, the reactions may be assumed to vary linearly across the base or across the pile system.

6.7.1.2 Critical sections in design of an isolated pad footing

The critical section in design of an isolated pad footing may be taken as that at the face of the column or wall supported.

6.7.1.3 Pockets for precast members

Account should be taken of pockets for precast members in calculating section resistances, unless grouted up with a cement mortar not weaker than the concrete in the base.

6.7.2 Design of pad footings

6.7.2.1 Design moment

The design moment on a vertical section taken completely across a pad footing should be taken as that due to all external design ultimate loads and reactions on one side of that section. No redistribution of moments should be made.

6.7.2.2 Distribution of reinforcement

For the purposes of this sub-clause the reinforcement considered is that at right angles to the section. Where l_c exceeds $(3c/4 + 9d/4)$, two-thirds of the required reinforcement should be concentrated within a zone from the centre-line of the column to a distance $1.5d$ from the face of the column; otherwise the reinforcement should be uniformly distributed over l_c where:

- c is the column width.
- d is the effective depth of a pad footing or pile cap.
- l_c is half the spacing between column centres (if more than one) or the distance to the edge of the pad (whichever is the greater).

6.7.2.3 Design shear

The design shear is the algebraic sum of all design ultimate vertical loads acting on one side of or outside the periphery of the critical section (see clauses 6.1.3.5 and 6.1.3.6).

6.7.2.4 Design shear strength near concentrated load

Design shear strength near concentrated loads is governed by the more severe of the following two conditions.

- (a) shear along a vertical section extending across the full width of a base. See clauses 6.1.3.5 (a) and (b) (which deal with the design shear resistance of slabs).
- (b) punching shear around the loaded area. Use clause 6.1.5.6 except that no shear reinforcement is needed when $v < v_c$.

6.7.3 Design of pile caps

6.7.3.1 General

Pile caps can be designed as rigid or flexible, taking into account various factors including pile spacing and arrangement pile cap thickness, loading configuration, details of superstructure etc.

Flexible pile caps are designed either by bending theory or by truss analogy; if the latter is used the truss should be of triangulated form, with a node at the centre of loaded area. The lower nodes of the truss lie at the intersections of the centre-lines of the piles with the tensile reinforcement. For widely spaced piles (spacing exceeding three times the pile diameter), only the reinforcement within 1.5 times

the pile diameter from the centre of a pile should be considered to constitute a tension member of the truss.

6.7.3.2 Shear forces

The design shear strength of a pile cap is normally governed by the shear along a vertical section extending across the full width of the cap. Critical sections for the shear should be assumed to be located 20% of the diameter of the pile inside the face of the pile, as indicated in Figure 6.19. The whole of the force from the piles with centres lying outside this line should be considered to be applied outside this line.

6.7.3.3 Design shear resistance

The design shear resistance of pile caps may be determined in accordance with clauses 6.1.3.5 and 6.1.3.6, subject to the following limitations.

- In applying these provisions, a_v is the distance from the face of the column to the critical section as defined in clause 6.7.3.2.
- Where the shear distribution across section has not been considered (as in the simplified rigid cap analysis), shear enhancement shall not be applied.
- Where due consideration has been given to the shear distribution across section, shear enhancement may be applied to the strip of the pile cap of width equal to 3ϕ , centred on each pile, where ϕ is the pile diameter. For H-section and rectangular piles, the width for shear enhancement 3ϕ may be replaced by the width of the pile plus 2 times the least dimension of the pile.
- In consideration of the shear distribution across section, the shear force may be averaged over a width which should not extend beyond one effective depth on either side from the pile centre, or as limited by the actual dimension of the pile cap.
- Minimum stirrups are not required in the pile cap where $v < v_c$ (enhanced if appropriate).
- The tension reinforcement should be provided with a full anchorage in accordance with clause 8.4.

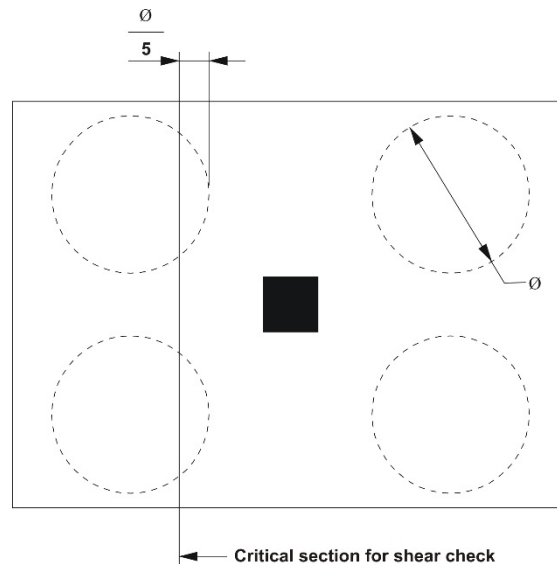

Figure 6.19 - Critical section for shear check in a pile cap

6.7.3.4 Punching shear

A check should be made to ensure that the design shear stress calculated at the perimeter of the column does not exceed $0.8\sqrt{f_{cu}}$ N/mm² or 7.0 N/mm², whichever is the lesser. The maximum shear capacity may also be limited by the provisions of clause 6.1.5.7 (e). In addition, if the spacing of the piles is greater than 3ϕ , punching shear should be checked in accordance with clause 6.1.5.7.

6.7.3.5 Torsion

The effects of torsion for a rigid pile cap should be checked based on rigid body theory, taking into account the loading configuration and the pile reactions. Where necessary, torsional reinforcement in accordance with clause 6.3 should be provided.

6.8 BEAM – COLUMN JOINTS

6.8.1 General principles and requirements

6.8.1.1 Design criteria

Beam-column joints shall satisfy the following criteria:

- (a) at serviceability limit state, a joint shall perform at least as well as the members that it joins; and
- (b) at ultimate limit state, a joint shall have a design strength sufficient to resist the most adverse load combinations sustained by the adjoining members, as specified in Table 2.1.

6.8.1.2 Design forces

The design forces acting on a beam-column joint shall be evaluated from the maximum internal forces in all members meeting at the joint under the most adverse load combinations at ultimate limit state as specified in Table 2.1, with the joint in equilibrium.

The design forces for beam-column joint of lateral load resisting frames, where critical zones may be located at beam ends adjacent to the column, should be calculated by taking the most adverse combined net moments and forces at the joint under the load combinations at ultimate limit state as specified in Table 2.1, with the joint in equilibrium. Where reversal of beam end moment occurs, the beam-column joint design should also be calculated by taking the required amount of longitudinal beam reinforcement entering the beam-column joint at yield, i.e. f_y . With gravity load dominated frames where reversal moments will not occur at the beam end, yielding of bottom beam reinforcement need not be considered.

At columns of two-way frames, where beams frame into the joint from two directions, these forces need only be considered in each direction independently.

6.8.1.3 Joint shear stress

The horizontal joint shear stress computed with equation 6.71 shall not exceed $0.2f_{cu}$.

$$v_{jh} = \frac{V_{jh}}{b_j h_c} \quad 6.71$$

where:

V_{jh} is the total horizontal design joint shear force in the direction being considered, i.e. either V_{jx} or V_{jy} as appropriate. The magnitude of the horizontal design shear force shall be evaluated from a rational analysis taking into account the effect of all forces on the joint including the beneficial column shear forces.

V_{jx} is the total horizontal design joint shear force in x direction,

V_{jy} is the total horizontal design joint shear force in y direction,

h_c is the overall depth of column in the direction of the horizontal shear being considered,

b_j is the effective joint width (see Figure 6.20), which shall be taken as:

for $b_c \geq b_w$: $b_j = b_c$, or $b_w + 0.5h_c$, whichever is the smaller; and

for $b_c < b_w$: $b_j = b_w$, or $b_c + 0.5h_c$, whichever is the smaller.

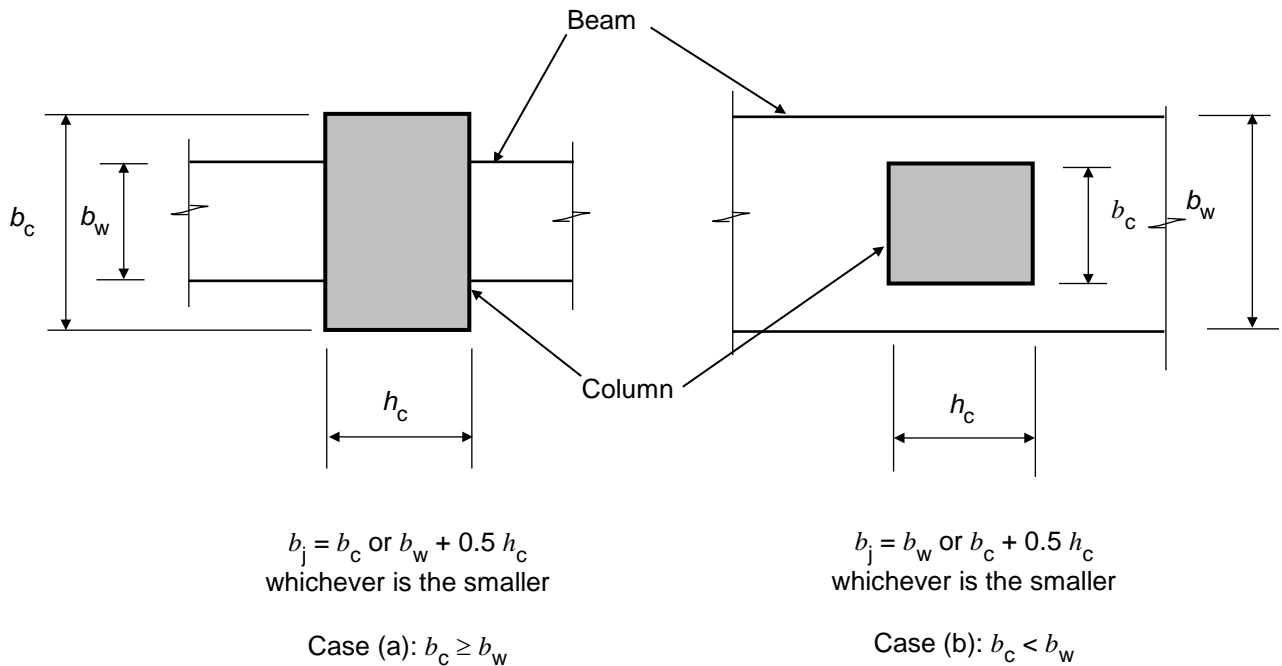

Figure 6.20 - Effective joint widths

6.8.1.4 Design principles

The joint shear shall be assumed to be resisted by a strut mechanism comprising a diagonal concrete strut and a truss mechanism comprising horizontal and vertical joint shear reinforcement and numerous diagonal concrete struts. Corner joints of portal frame structures, and joints in other appropriate applications, shall be detailed on the basis of rational analysis so that shear forces are transferred by an acceptable mechanism and so that anchorage of the flexural reinforcement within the joint is assured.

For the design of joint shear reinforcement, the potential tension failure plane may be considered as extending from one corner of the joint to the diagonally opposite edge.

6.8.1.5 Horizontal joint shear reinforcement

The area of total effective horizontal joint shear reinforcement corresponding with each direction of horizontal joint shear force shall be:

$$A_{jh} = \frac{V_{jh}}{0.87 f_{yh}} \left(0.5 - \frac{C_j N^*}{0.8 A_g f_{cu}} \right) \quad 6.72$$

where:

A_g is the gross area of column section in mm^2 ,

C_j is the ratio: $\frac{V_{jh}}{V_{jx} + V_{jy}}$; ($C_j = 1$ if the joint has beams in one direction only)

N^* is the minimum design axial column load at the ultimate limit state occurring simultaneously with V_{jh} , taken positive when causing compression. For axial tension load, $C_j=1$ must be assigned,

f_{yh} is the characteristic yield strength of the horizontal joint shear reinforcement.

Horizontal joint shear reinforcement shall consist of links or hoops uniformly distributed between but not immediately adjacent to the innermost layers of the top and bottom beam reinforcement.

6.8.1.6 Vertical joint shear reinforcement

The area of total effective vertical joint reinforcement corresponding with each direction of horizontal joint shear force shall be:

$$A_{jv} = \frac{0.4(h_b / h_c)V_{jh} - C_j N^*}{0.87 f_{yv}} \quad 6.73$$

where:

h_b is the overall depth of the beam,

f_{yv} is the characteristic yield strength of the vertical joint shear reinforcement.

Vertical joint shear reinforcement should consist of vertical links or intermediate column bars adequately anchored in the column and placed between the corner bars and within the effective joint area as defined in clause 6.8.1.3.

Centre-to-centre spacing of the required vertical joint shear reinforcement in either direction should not exceed 200 mm or one-quarter of the lateral dimension of the joint in the orthogonal direction, whichever is the larger. Each vertical face of the joint should be provided with at least one vertical joint shear bar.

6.8.1.7 Horizontal transverse reinforcement

The horizontal transverse reinforcement in beam-column joints shall not be less than that required by clause 9.5.2, with the exception of joints connecting beams at all four column faces in which case the transverse joint reinforcement may be reduced to one-half of that required in clause 9.5.2. In no case shall the spacing of the transverse reinforcement in the joint core exceed 10 times the diameter of the smallest column bar or 200 mm, whichever is the least.

7 SERVICEABILITY LIMIT STATES

7.1 GENERAL

7.1.1 Introduction

This section provides two alternative approaches for the design requirements of the serviceability limit states, namely:

- (a) by deemed-to-satisfy provisions, such as limiting span-to-depth ratios and applying specific detailing rules; and
- (b) by analysis whereby the calculated values of effects of loads, e.g. deformations and crack widths, are compared with acceptable values.

The two common serviceability limit states considered in this section are:

- (c) crack control; and
- (d) deflection control.

Other limit states (such as stress limitation and fatigue) may be of importance in particular structures but are not covered in this Code of Practice.

7.1.2 Assumptions

When carrying out an analysis approach (i.e. direct serviceability calculations) it is necessary to make sure that the assumptions made regarding loads and material properties are compatible with the way the results will be used.

If a best estimate of the expected behaviour is required, then the expected or most likely values should be used.

In contrast, in order to satisfy a serviceability limit state, it may be necessary to take a more conservative value depending on the severity of the particular serviceability limit state under consideration, i.e. the consequences of failure. (Failure here means failure to meet the requirements of a limit state rather than collapse of the structure.) It is clear that serviceability limit states vary in severity and furthermore what may be critical in one situation may not be important in another.

7.1.3 Loads

7.1.3.1 General

The loading assumed in serviceability calculations will depend on whether the aim is to produce a best estimate of the likely behaviour of the structure or to comply with a serviceability limit state requirement and, if the latter, the severity of that limit state.

In assessing the loads, a distinction should be made between "characteristic" and "expected" values. Generally, for best estimate calculations, expected values should be used. For calculations to satisfy a particular limit state, generally lower or upper bound values should be used depending on whether or not the effect is beneficial. The actual values assumed however should be a matter for engineering judgement.

For loads that vary with time, e.g. live and wind loads, it is necessary to choose values that are compatible with the response time of the structure and the assumptions made regarding material and section properties (see clause 7.1.5).

7.1.3.2 Dead loads

For dead loads, the expected and characteristic values are the same. Generally, in serviceability calculations (both best estimate and limit state) it will be sufficient to take the characteristic value.

7.1.3.3 Imposed loads

Generally, the characteristic value should be used in limit state calculations and the expected value in best estimate calculations.

When calculating deflections, it is necessary to assess how much of the load is permanent and how much is transitory. The proportion of the imposed load that should be considered as permanent will, however, depend on the type of structure. It is suggested that for normal domestic or office occupancy, 25% of the imposed load should be considered as permanent and for structures used for storage, at least 75% should be considered permanent when the upper limit to the deflection is being assessed.

7.1.4 Analysis of structure for serviceability limit states

In general, it will be sufficiently accurate to assess the moments and forces in members subjected to their appropriate loadings for the serviceability limit states using an elastic analysis. Where a single value of stiffness is used to characterise a member, the member stiffness may be based on the concrete section. In this circumstance it is likely to provide a more accurate picture of the moment and force fields than will the use of a cracked transformed section, even though calculation shows the members to be cracked. Where more sophisticated methods of analysis are used in which variations in properties over the length of members can be taken into account, it will frequently be more appropriate to calculate the stiffness of highly stressed parts of members on the basis of a cracked transformed section.

7.1.5 Material properties for the calculation of curvature and stresses

For checking serviceability limit states, the modulus of elasticity of the concrete should be taken as the value given in Table 3.2. The modulus of elasticity may be corrected for the age of loading where this is known. Where a 'best estimate' of the curvature is required, an elastic modulus appropriate to the expected concrete strength may be used. Attention is, however, drawn to the large range of values for the modulus of elasticity that can be obtained for the same cube strength. It may therefore be appropriate to consider either calculating the behaviour using moduli in Table 3.2 to obtain an idea of the reliability of the calculation or to have tests done on the actual concrete to be used. Refer to section 3 for appropriate values for creep and shrinkage in the absence of more direct information.

7.2 CRACKING

7.2.1 General

Cracking shall be limited to an extent that will not impair the proper functioning or durability of the structure or cause its appearance to be unacceptable. Cracking is normal in reinforced concrete structures subjected to flexure, shear, torsion or tension resulting from either direct loading or restraint of imposed deformations.

Appropriate limitations, taking into account of the proposed function and nature of the structure and the costs of limiting cracking, should be established. It may be assumed that the limitations of the maximum estimated crack width given in Table 7.1 will generally be satisfactory for reinforced concrete members in buildings with respect to appearance and durability.

| Exposure condition | Reinforced members and prestressed members with unbonded tendons | Prestressed members with bonded tendons |
|---|--|---|
| 1, 2, and 3 | 0.3 mm ⁽¹⁾ | 0.2 mm |
| 4 | 0.3 mm | 0.2 mm |
| Water retaining structures ⁽²⁾ | 0.2 mm | - |
| Notes: 1. For exposure condition 1, crack width has no influence on durability and this limit is set to guarantee acceptable appearance. In the absence of appearance conditions this limit may be relaxed. 2. Water retaining structures referred to here are water tanks and the like used in general building works and not meant to include large civil water retaining structures. | | |

Table 7.1 - Limitations of maximum estimated surface crack widths

Since the bar spacing rules given in section 9 for particular members have to ensure that cracking is not serious in the worst likely practical situation, it will almost always be found that wider bar spacings can be used if the crack widths are checked explicitly. This will be particularly true for fairly shallow members.

7.2.2 Control of cracking without direct calculation (deemed-to-satisfy)

If the detailing rules prescribed in sections 8 and 9 with respect to minimum reinforcement areas and bar spacings are complied with, no further checks on crack widths are usually necessary.

However, should it be considered appropriate to estimate crack widths, the approach in clause 7.2.3 may be followed.

7.2.3 Assessment of crack widths

The widths of flexural cracks at a particular point on the surface of a member depend primarily on three factors:

- the proximity to the point considered of reinforcing bars perpendicular to the cracks;
- the proximity of the neutral axis to the point considered; and
- the average surface strain at the point considered.

Equation 7.1 gives a relationship between crack width and these three principal variables which gives acceptably accurate results in most normal design circumstances; however, the formula should be used with caution in members subjected dominantly to an axial tension.

It should be remembered that cracking is a semi-random phenomenon and that an absolute maximum crack width cannot be predicted. The formula is designed to give a width with an acceptably small chance of being exceeded, thus an occasional crack slightly larger than the predicted width should not be considered as cause for concern. However, should a significant number of cracks in a structure exceed the calculated width, reasons other than the statistical nature of the phenomenon should be sought to explain their presence.

Provided the strain in the tension reinforcement is limited to $0.8f_y/E_s$, the design surface crack width, which should not exceed the appropriate value given in clause 7.2.1 may be calculated from the following equation:

$$\text{Design surface crack width } \omega = \frac{3a_{cr}\varepsilon_m}{1 + 2\left(\frac{a_{cr} - c_{min}}{h - x}\right)} \quad 7.1$$

where:

- a_{cr} is the distance from point considered to the surface of the nearest longitudinal bar,
- ε_m is the average strain at the level where the cracking is being considered,
- c_{min} is the minimum cover to the tension steel.

The average strain ε_m may be calculated on the basis of the assumptions given in clause 7.3.6.

Alternatively, as an approximation, it will normally be satisfactory to calculate the steel stress on the basis of a cracked section and then reduce this by an amount equal to the tensile force generated by the stress distribution defined in clause 7.3.6 (a) acting over the tension zone divided by the steel area. For a rectangular tension zone, this gives:

$$\varepsilon_m = \varepsilon_1 - \frac{b_t(h-x)(a'-x)}{3E_sA_s(d-x)} \text{ for a limiting design surface crack width of 0.2 mm ;} \quad 7.2$$

$$\varepsilon_m = \varepsilon_1 - \frac{1.5b_t(h-x)(a'-x)}{3E_sA_s(d-x)} \text{ for a limiting design surface crack width of 0.1 mm} \quad 7.2(a)$$

where:

- ε_1 is the strain at the level considered, calculated ignoring the stiffening effect of the concrete in the tension zone,
- a' is the distance from the compression face to the point at which the crack width is being calculated,
- b_t is the width of the section at the centroid of the tension steel.

In equation 7.2 for cases where the whole section is in tension, an effective value of $(h - x)$ can be estimated by interpolation between the following limiting conditions:

- where the neutral axis is at the most compressed face, $(h - x) = h$ (i.e. $x = 0$); and
- for axial tension, $(h - x) = 2h$.

A negative value for ε_m indicates that the section is uncracked.

In assessing the strains, the modulus of elasticity of the concrete should be taken as half the instantaneous values.

Where it is expected that the concrete may be subject to abnormally high shrinkage (> 0.0006), ϵ_m should be increased by adding 50% of the expected shrinkage strain; otherwise, shrinkage may be ignored.

Note: This approach makes a notional allowance for long-term effects.

7.2.4 Early thermal cracking

7.2.4.1 General

In pours that are subjected to either internal or external restraint, thermal stresses may develop which can cause cracking. Cracking can occur through two different mechanisms.

(a) Internal temperature gradients

Cracking due to differential temperature changes is most common in massive pours. Since the low thermal conductivity of concrete prevents rapid heat dissipation, the temperature in the mass of concrete increases. The concrete surface, in direct contact with the environment, loses heat more quickly and therefore undergoes a much lower rise in temperature. The resulting expansion of the hot core, if excessive, can stretch the cooler surface zone to the extent that cracking occurs. During subsequent cooling, the opposite effect may occur causing internal cracking of the central zone.

(b) External restraint during cooling

Cracking resulting from restraint to thermal movement most commonly occurs in walls cast into rigid bases. During the temperature rise period, the concrete has a relatively low elastic modulus and the compressive stresses due to restrained expansion are easily relieved by creep. During cooling, the concrete matures and, when the thermal contraction is restrained, the tensile stresses generated are less easily relieved. These can be of sufficient magnitude to cause cracking which commonly occurs at the half or one-third points along a bay. In the extreme case of a fully restrained element, a change in temperature of the order of only 10°C can result in cracking. Therefore, the high temperature rises which can result in long-term strength reductions are not essential to the promotion of cracks. However, if there was no restraint, the concrete would contract without cracking.

Typical values of restraint recorded for a range of pour configurations have been given in Table 7.2. For most situations there is always some degree of restraint but complete restraint is very rare. Even when a wall is cast on to a nominally rigid foundation, the restraint is unlikely to exceed a value of R equal to 0.70. To minimize restraint, infill bays should be avoided wherever possible and the pour provided with a free end to accommodate thermal movement.

| Pour configuration | Restraint factor (R) |
|--|---|
| Thin wall cast on to massive concrete base | 0.6 to 0.8 at base 0.1 to 0.2 at top |
| Massive pour casting into blinding | 0.1 to 0.2 |
| Massive pour cast on to existing mass concrete | 0.3 to 0.4 at base 0.1 to 0.2 at top |
| Suspended slabs | 0.2 to 0.4 |
| Infill bays, i.e. rigid restraint | 0.8 to 1.0 |

Table 7.2 - Values of external restraint recorded in various structures

7.2.4.2 Estimating early thermal crack widths

The restrained component of the thermal strain ϵ_r , which will be accommodated by cracks is given by the following equation:

$$\epsilon_r = 0.8\alpha(T_1 + T_2)R \quad 7.3$$

where:

R is the restraint factor (see Table 7.2),

- α is the coefficient of thermal expansion of concrete,
- T_1 is the short-term fall in temperature from hydration peak to ambient conditions,
- T_2 is the long-term fall in temperature from ambient to seasonal minimum,
- ε_r is the strain accompanied by cracking.

Crack widths may be estimated by substituting ε_r for ε_m in equation 7.1.

Reinforcement that is present in the section for other purposes may be included as part of reinforcement necessary to satisfy the requirements for the control of early thermal cracking.

7.3 DEFORMATIONS

7.3.1 General considerations

The deformation of a member or structure shall not be such that it adversely affects its proper functioning or appearance.

Appropriate limiting values of deflection taking into account the nature of the structure, of the finishes, partitions and fixings and upon the function of the structure should be established.

Deformations should not exceed those that can be accommodated by other connected elements such as partitions, glazing, cladding, services or finishes. In some cases limitation may be required to ensure the proper functioning of machinery or apparatus supported by the structure, or to avoid ponding on flat roofs.

The appearance and general utility of the structure may be impaired when the calculated sag of a beam, slab or cantilever subjected to quasi-permanent loads exceeds span/250. The sag is assessed relative to the supports. Pre-camber may be used to compensate for some or all of the deflection but any upward deflection incorporated in the formwork should not generally exceed span/250.

Deflections that could damage adjacent parts of the structure should be limited. For the deflection after construction, span/500 is normally an appropriate limit for quasi-permanent loads. Other limits may be considered, depending on the sensitivity of adjacent parts.

The limit state of deformation may be checked by either:

- (a) limiting the span/depth ratio, according to clause 7.3.4; or
- (b) comparing a calculated deflection, according to clause 7.3.5, with a limit value.

The actual deformations may differ from the estimated values, particularly if the values of applied moments are close to the cracking moment. The differences will depend on the dispersion of the material properties, on the environmental conditions, on the load history, on the restraints at the supports, ground conditions, etc.

7.3.2 Excessive response to wind loads

Excessive accelerations under wind loads that may cause discomfort or alarm to occupants should be avoided. A static or dynamic analysis could be employed taking into account the pertinent features of the structure and its surroundings. Limiting deflection at the top of a building to $H/500$ where H should be measured from the highest floor level excluding plant rooms/roof features and alike, when considering a static characteristic wind load should result in an acceptable environment for occupants in normal buildings.

Partitions cladding and finishes, etc. need to be specifically detailed to allow for the anticipated relative lateral deflection in any one storey under the characteristic wind load.

Where a dynamic analysis is undertaken, the maximum peak acceleration of the building should be assessed for wind speeds based on a 1-in-10-year return period of 10 minutes duration with the following limits:

| Function | Peak Acceleration |
|-----------------|-----------------------|
| Residential | 0.15 m/s ² |
| Office or hotel | 0.25 m/s ² |

The use of dampers on tall and slender buildings should be supported with dynamic analysis and specialist literature should be consulted.

7.3.3 Excessive vibration

Excessive vibration due to fluctuating loads that may cause discomfort or alarm to occupants, either from people or machinery, should be avoided. For a building floor structure with the natural frequency less than 6 Hz, or a footbridge superstructure with the natural frequency less than 5 Hz, a dynamic analysis may be desirable.

Note: For further guidance reference should be made to specialist literature.

7.3.4 Limiting deflection without direct calculation (deemed-to-satisfy)

7.3.4.1 General

Generally, it is not necessary to calculate the deflections explicitly as simple rules, for example limits to span-to-depth ratio may be formulated, which will be adequate for avoiding deflection problems in normal circumstances. More rigorous checks are necessary for members which lie outside such limits, or where deflection limits other than those implicit in simplified methods are appropriate.

7.3.4.2 Span to effective depth ratio

Provided that reinforced concrete beams or slabs in buildings are dimensioned so that they comply with the limits of span-to-depth ratio given in Table 7.3, their deflections may be considered as not exceeding the limits set out in clause 7.3.1. No allowance has been made for any pre-camber in the derivation of these limits.

| Support condition | Rectangular beam | Flanged beam $b_w/b \leq 0.3$ | One or two-way spanning solid slab |
|-------------------|------------------|----------------------------------|------------------------------------|
| Cantilever | 7 | 5.5 | 7 |
| Simply-supported | 20 | 16 | 20 |
| Continuous | 26 | 21 | 26 |
| End span | 23 | 18.5 | 23 ⁽²⁾ |

Notes:

1. The values given have been chosen to be generally conservative and calculation may frequently show that shallower sections are possible.
2. The value of 23 is appropriate for two-way spanning slab if it is continuous over one long side.
3. For two-way spanning slabs the check should be carried out on the basis of the shorter span.

Table 7.3 - Basic span/effective depth ratio for reinforced concrete sections

7.3.4.3 Long spans

For spans exceeding 10 m, Table 7.3 should be used only if it is not necessary to limit the increase in deflection after the construction of partitions and finishes. Where limitation is necessary, the values in Table 7.3 should be multiplied by 10/span except for cantilevers where the design should be justified by calculation.

7.3.4.4 Modification of span/depth ratios for tension reinforcement

Deflection is influenced by the amount of tension reinforcement and its stress. The span/effective depth ratio should therefore be modified according to the ultimate design moment and the service stress at the centre of the span (or at the support in the case of a cantilever). Values of span/effective depth ratio obtained from Table 7.3 should be multiplied by the appropriate factor obtained from Table 7.4.

| Service stress | M/bd^2 | | | | | | | | | |
|----------------|----------|------|------|------|------|------|------|------|------|------|
| | 0.50 | 0.75 | 1.00 | 1.50 | 2.00 | 3.00 | 4.00 | 5.00 | 6.00 | |
| $(f_y = 250)$ | 100 | 2.00 | 2.00 | 2.00 | 1.86 | 1.63 | 1.36 | 1.19 | 1.08 | 1.01 |
| | 150 | 2.00 | 2.00 | 1.98 | 1.69 | 1.49 | 1.25 | 1.11 | 1.01 | 0.94 |
| | 167 | 2.00 | 2.00 | 1.91 | 1.63 | 1.44 | 1.21 | 1.08 | 0.99 | 0.92 |
| | 200 | 2.00 | 1.95 | 1.76 | 1.51 | 1.35 | 1.14 | 1.02 | 0.94 | 0.88 |
| | 250 | 1.90 | 1.70 | 1.55 | 1.34 | 1.20 | 1.04 | 0.94 | 0.87 | 0.82 |
| $(f_y = 500)$ | 300 | 1.60 | 1.44 | 1.33 | 1.16 | 1.06 | 0.93 | 0.85 | 0.80 | 0.76 |
| | 333 | 1.41 | 1.28 | 1.18 | 1.05 | 0.96 | 0.86 | 0.79 | 0.75 | 0.72 |

Notes:

- The values in the table are derived from the following equation:

$$\text{Modification factor} = 0.55 + \frac{(477 - f_s)}{120 \left(0.9 + \frac{M}{bd^2} \right)} \leq 2.0$$
where:
 M is the design ultimate moment at the centre of the span or, for a cantilever, at the support.
- The design service stress in the tension reinforcement in a member may be estimated from the equation:

$$f_s = \frac{2f_y A_{s, req}}{3A_{s, prov}} \times \frac{1}{\beta_b}$$
 - see clause 6.1.2.4 (b) for definition of β_b
- For a continuous beam, if the percentage of redistribution is not known but the design ultimate moment at mid-span is obviously the same as or greater than the elastic ultimate moment, the stress f_s in this table may be taken as $2/3 f_y$.

Table 7.4 - Modification factor for tension reinforcement

7.3.4.5 *Modification of span/depth ratios for compression reinforcement*

Compression reinforcement also influences deflection and the value of the span/effective depth ratio obtained from Table 7.3 modified by the factor obtained from Table 7.4 may be multiplied by a further factor obtained from Table 7.5.

| $100 \frac{A'_{s, prov}}{bd}$ | Factor |
|-------------------------------|--------|
| 0.00 | 1.00 |
| 0.15 | 1.05 |
| 0.25 | 1.08 |
| 0.35 | 1.10 |
| 0.50 | 1.14 |
| 0.75 | 1.20 |
| 1.00 | 1.25 |
| 1.50 | 1.33 |
| 2.00 | 1.40 |
| 2.50 | 1.45 |
| ≥ 3.00 | 1.50 |

Notes:

- The values in this table are derived from the following equation

$$\text{Modification factor for compression reinforcement} = 1 + \frac{100A'_{s, prov}}{bd} / \left(3 + \frac{100A'_{s, prov}}{bd} \right) \leq 1.5$$
- The area of compression reinforcement $A'_{s, prov}$ used in this table may include all bars in the compression zone, even those not effectively tied with links.

Table 7.5 - Modification factor for compression reinforcement

7.3.4.6 *Deflection due to creep and shrinkage*

Permissible span/effective depth ratios obtained from Tables 7.3, 7.4 and 7.5 take account of normal creep and shrinkage deflection. If it is expected that creep or shrinkage of the concrete may be particularly high (e.g. if the free shrinkage strain is expected to be greater than 0.00075 or the creep coefficient greater than 3) or if other abnormally adverse conditions are expected, the permissible span/effective depth ratio should be suitably reduced.

7.3.5 **Calculation of deflection**

7.3.5.1 *General*

When it is deemed necessary to calculate the deflections of reinforced concrete members, it should be realised that there are a number of factors that may be difficult to allow for in the calculation which can have a considerable effect on the reliability of the result. These are as follows:

- (a) estimates of the restraints provided by supports are based on simplified and often inaccurate assumptions;
- (b) the precise loading, or that part which is of long duration, is unknown;
- (c) lightly reinforced members may well have a working load that is close to the cracking load for the members. Considerable differences will occur in the deflections depending on whether the member has or has not cracked; and
- (d) the effects on the deflection of finishes and partitions are difficult to assess and are often neglected.

The dead load is the major factor determining the deflection, as this largely governs the long-term effects. Because the dead load is known to within quite close limits, lack of knowledge of the precise imposed load is not likely to be a major cause of error in deflection calculations. Imposed loading is highly uncertain in most cases; in particular, the proportion of this load which may be considered to be permanent and will influence the long-term behaviour (see clause 7.1.3.3).

Finishes and rigid partitions added after the member is carrying its self-weight will help to reduce the long-term deflection of a member. As the structure creeps, any screed will be put into compression, thus causing some reduction in the creep deflection. The screed will generally be laid after the propping has been removed from the member, and so a considerable proportion of the long-term deflection will have taken place before the screed has gained enough stiffness to make a significant contribution. It is suggested that only 50% of the long-term deflection should be considered as reduceable by the action of the screed. If partitions of blockwork are built up to the underside of a member and no gap is left between the partition and the member, creep can cause the member to bear on the partition which, since it is likely to be very stiff, will effectively stop any further deflection along the line of the wall. If a partition is built on top of a member where there is no wall built up to the underside of the member, the long-term deflection will cause the member to creep away from the partition. The partition may be left spanning as a self-supporting deep beam that will apply significant loads to the supporting member only at its ends. Thus, if a partition wall is built over the whole span of a member with no major openings near its centre, its mass may be ignored in calculating long-term deflections.

A suitable approach for assessing the magnitude of these effects is to calculate a likely maximum and minimum to their influence and take the average.

7.3.5.2 *Calculation of deflection from curvatures*

The deflected shape of a member is related to the curvatures by the equation:

$$\frac{1}{r_x} = \frac{d^2 a}{dx^2} \quad 7.4$$

where:

- $\frac{1}{r_x}$ is the curvature at x ,
 a is the deflection at x .

Deflections may be calculated directly from this equation by calculating the curvatures at successive sections along the member and using a numerical integration technique. Alternatively, the following simplified approach may be used:

$$a = Kl^2 \frac{1}{r_b} \quad 7.5$$

where:

l is the effective span of the member,

$\frac{1}{r_b}$ is the curvature at mid-span or, for cantilevers, at the support section,

K is a constant that depends on the shape of the bending moment diagram.

Table 7.6 gives values of the coefficient K for various common shapes of bending moment diagram. As the calculation method does not describe an elastic relationship between moment and curvature, deflections under complex loads cannot be obtained by summing the deflections obtained by separate calculation for the constituent simpler loads. A value of K appropriate to the complete load should be used.

The calculation of the deflection of cantilevers requires very careful consideration in some circumstances. The usual formulae for the end deflection of cantilevers assume that the cantilever is rigidly fixed and is therefore horizontal at the root. In practice, this is by no means necessarily so, because the loading on the cantilever itself, or on other members to which the cantilever connects, may cause the root of the cantilever to rotate. If this root rotation is θ , the deflection of the tip of the cantilever will be decreased or increased by an amount $l\theta$.











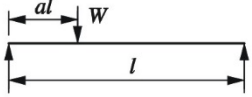
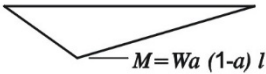

| Loading | Bending moment diagram | K |
|---|--|--|
|  |  | 0.125 |
|  |  | $\frac{3 - 4a^2}{48(1-a)}$ if $a = \frac{1}{2}$ $K = \frac{1}{12}$ |
|  |  | 0.0625 |
|  |  | $0.125 - \frac{a^2}{6}$ |
|  |  | 0.104 |
|  |  | 0.102 |
|  |  | $K = 0.104 \left(1 - \frac{\beta}{10}\right)$ $\beta = \frac{M_A + M_B}{M_C}$ |
|  |  | end deflection $= \frac{a(3-a)}{6}$ load at end $K = 0.333$ |
|  |  | $\frac{a(4-a)}{12}$ if $a = 1$ $K = 0.25$ |
|  |  | $K = 0.083 \left(1 - \frac{\beta}{4}\right)$ $\beta = \frac{M_A + M_B}{M_C}$ |
|  |  | $\frac{1}{80} \frac{(5-4a^2)^2}{3-4a^2}$ |

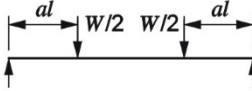
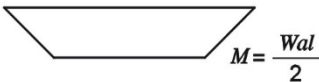
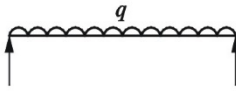
Table 7.6 - Values of K for various bending moment diagrams

There are two sources of root rotation that may occur. First, rotation of the joint in the frame to which the cantilever connects. This problem will require attention only when the supporting structure is fairly flexible. Secondly, even where the cantilever connects to a substantially rigid structure, some root rotation will occur. This is because the steel stress, which is at a maximum at the root, should be dissipated into the supporting structure over some length of the bar embedded in the support. To allow for this, it is important to use the effective span of the cantilever as defined in clause 5.2.1.2 (b).

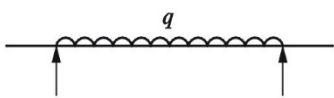
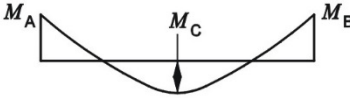
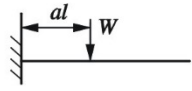
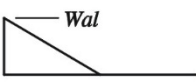
If Table 7.6 is used to assess the value of K by superposition, it may be assumed that the maximum deflection of a beam occurs at mid-span without serious errors being introduced.

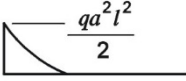
The problem of estimating the deflection of two-way spanning slabs is not simple. Before they crack, slabs will behave substantially as elastic, isotropic slabs. As soon as cracking occurs, the slabs become anisotropic, the amount of this anisotropy varying continuously as the loading varies, and so a reliable determination of the moment surface for the slab under any particular load is not normally practicable. Deflections of slabs are therefore probably best dealt with by using the ratios of span to effective depth. However, if the engineer feels that the calculation of the deflections of a slab is essential, it is suggested that the following procedure be adopted.

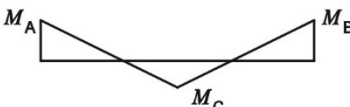
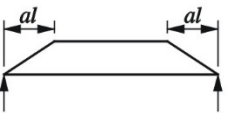
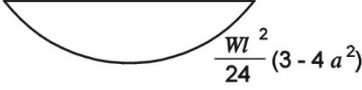
A strip of slab of unit width is chosen such that the maximum moment along it is the maximum moment of the slab, i.e. in a rectangular slab, a strip spanning across the shorter dimension of the slab connecting the centres of the longer sides. The bending moments along this strip should preferably be obtained from an elastic analysis of the slab but may be assessed approximately by taking 70% of the moments used for the collapse design. The deflection of the strip is then calculated as though it was a beam. This method will be slightly conservative.

7.3.6 Calculation of curvatures

The curvature of any section may be calculated by employing whichever of the following sets of assumptions (a) or (b) gives the larger value. Item (a) corresponds to the case where the section is cracked under the loading considered, item (b) applies to an uncracked section.

(a) Cracked section (partially)

- (i) strains are calculated on the assumption that plane sections remain plane,
- (ii) the reinforcement, whether in tension or in compression, is assumed to be elastic. Its modulus of elasticity may be taken as 200 kN/mm²,
- (iii) the concrete in compression is assumed to be elastic. Under short-term loading the modulus of elasticity may be taken as that obtained from clause 7.1.5. Under long-term loading, an effective modulus may be taken having a value of $1/(1+\phi_c)$ times the short-term modulus where ϕ_c is the appropriate creep coefficient (see clause 3.1.7),
- (iv) stresses in the concrete in tension may be calculated on the assumption the stress distribution is triangular, having a value of zero at the neutral axis and a value at the centroid of the tension steel of 1 N/mm² instantaneously, reducing to 0.55 N/mm² in the long term.

(b) Uncracked section

The concrete and the steel are both considered to be fully elastic in tension and in compression. The elastic modulus of the steel may be taken as 200 kN/mm² and the elastic modulus of the concrete is as derived from (a) both in compression and in tension.

These assumptions are illustrated in Figure 7.1.

In each case, the curvature can be obtained from the following equation:

$$\frac{1}{r_b} = \frac{f_c}{xE_c} = \frac{f_s}{(d-x)E_s} \quad 7.6$$

where

- $\frac{1}{r_b}$ is the curvature at mid-span, or for cantilevers, at the support section,
- f_c is the design service stress in the concrete,
- E_c is the short-term modulus of the concrete,
- f_s is the estimated design service stress in the tension reinforcement,
- d is the effective depth of the section,

x is the depth to the neutral axis,
 E_s is the modulus of elasticity of the reinforcement.

For (b) the following alternative may be more convenient:

$$\frac{1}{r_b} = \frac{M}{E_c I}$$

where:

M is the moment at the section considered,
 I is the second moment of area.

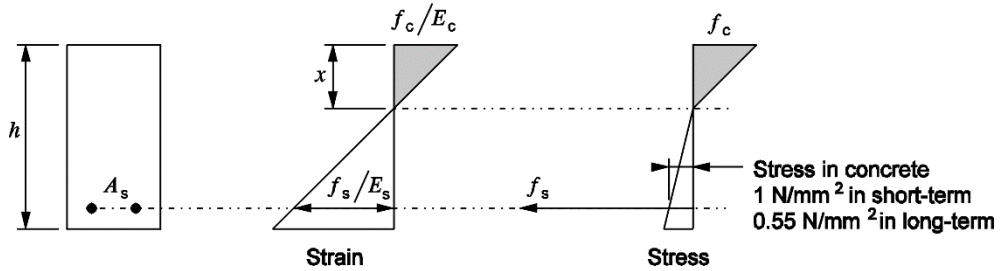

a) Cracked section (partially)

as above

as above

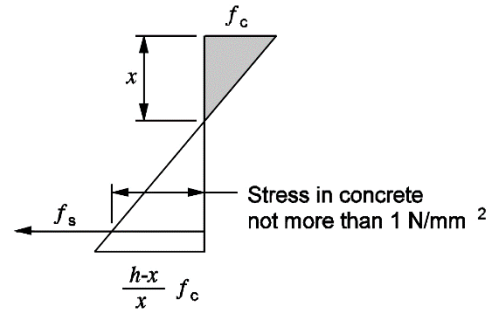

b) Uncracked section

where:

h is the overall depth of section,
 x is the depth from the compression face to the neutral axis,
 f_c is the maximum compressive stress in the concrete,
 f_s is the tensile stress in the reinforcement,
 E_s is the modulus of elasticity of the reinforcement.

Figure 7.1 - Assumptions made in calculating curvatures

Assessment of the stresses by using (a) requires a trial-and-error approach.

In assessing the total long-term curvature of a section, the following procedure may be adopted:

- (i) calculate the instantaneous curvatures under the total load (1) and under the permanent load (2);
- (ii) calculate the long-term curvature under the permanent load (3);
- (iii) add to the long-term curvature under the permanent load (3) the difference between the instantaneous curvature under the total (1) and permanent load (2); then
- (iv) add to this curvature the shrinkage curvature (4) calculated from the following equation:

$$\frac{1}{r_{cs}} = \rho_o \varepsilon_{cs} / d$$

7.7

where:

$\frac{1}{r_{cs}}$ is the shrinkage curvature,

ε_{cs} is the free shrinkage strain (see clause 3.1.8, but note that the K_s factor for reinforcement is not to be applied as the values given in Table 7.7 are more applicable for curvature calculations),

ρ_o is the coefficient which depends upon percentages of tension and compression reinforcement in the section. Values of ρ_o can be obtained from Table 7.7,

d is the effective depth to tension reinforcement.

| $100 \frac{A_s}{bd}$ | $100 \frac{A'_s}{bd}$ | | | | | | | | |
|----------------------|-----------------------|------|------|------|------|------|------|------|------|
| | 0.00 | 0.25 | 0.50 | 0.75 | 1.00 | 1.25 | 1.50 | 1.75 | 2.00 |
| 0.25 | 0.44 | 0.31 | 0.26 | 0.22 | 0.20 | 0.18 | 0.17 | 0.16 | 0.15 |
| 0.50 | 0.56 | 0.31 | 0.26 | 0.22 | 0.20 | 0.18 | 0.17 | 0.16 | 0.15 |
| 0.75 | 0.64 | 0.45 | 0.26 | 0.22 | 0.20 | 0.18 | 0.17 | 0.16 | 0.15 |
| 1.00 | 0.70 | 0.55 | 0.39 | 0.22 | 0.20 | 0.18 | 0.17 | 0.16 | 0.15 |
| 1.50 | 0.80 | 0.69 | 0.57 | 0.45 | 0.32 | 0.18 | 0.17 | 0.16 | 0.15 |
| 2.00 | 0.88 | 0.79 | 0.69 | 0.60 | 0.49 | 0.39 | 0.28 | 0.16 | 0.15 |
| 2.50 | 0.95 | 0.87 | 0.79 | 0.70 | 0.62 | 0.53 | 0.44 | 0.35 | 0.25 |
| 3.00 | 1.00 | 0.94 | 0.86 | 0.79 | 0.72 | 0.64 | 0.57 | 0.49 | 0.40 |
| 3.50 | 1.00 | 1.00 | 0.93 | 0.87 | 0.8 | 0.74 | 0.67 | 0.60 | 0.52 |
| 4.00 | 1.00 | 1.00 | 1.00 | 0.93 | 0.87 | 0.81 | 0.75 | 0.69 | 0.62 |

Table 7.7 - Values of ρ_o for calculation of shrinkage curvatures

The above procedure for the calculation of long-term curvature is logical and its net effect is illustrated in Figure 7.2.

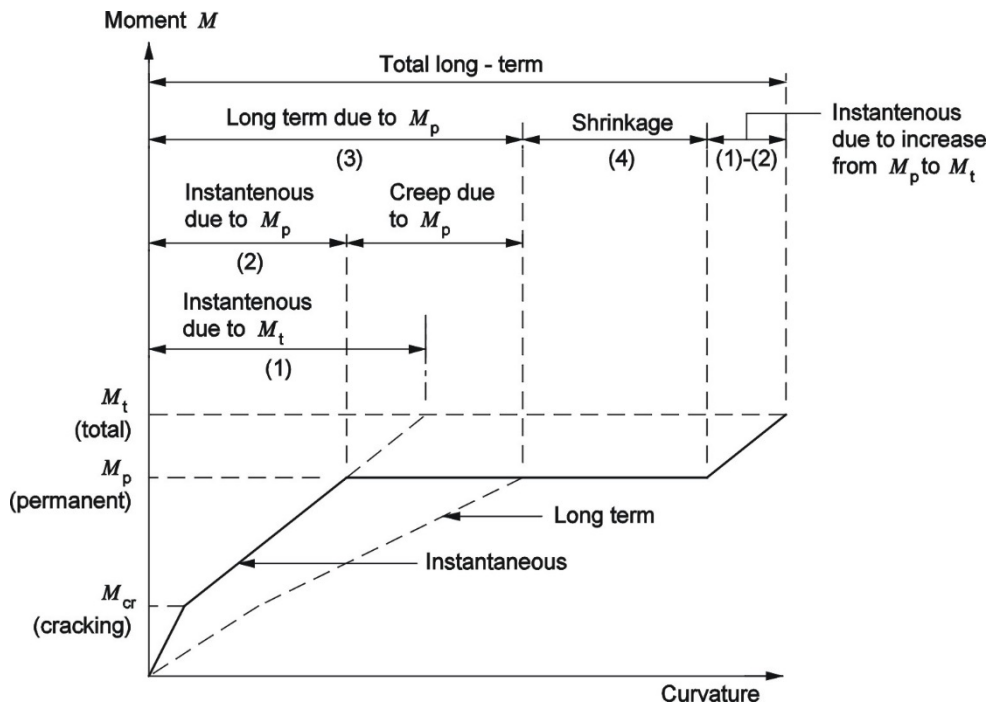

Figure 7.2 - Loading history for serviceability limit state - curvature

8 REINFORCEMENT: GENERAL REQUIREMENTS

8.1 GENERAL

8.1.1 Scope

The rules given in this section apply to all reinforcement, welded fabric and prestressing tendons subjected predominantly to static loading. They are applicable for normal buildings structures. They do not apply to:

- (a) elements subjected to dynamic loading caused by seismic effects or machine vibration, impact loading, fatigue; and
- (b) elements incorporating specially painted, epoxy or zinc coated bars.

The requirements concerning minimum concrete cover shall be satisfied by the limitations set out in Table 4.2.

Additional rules are provided for large diameter bars. See clause 8.8.

8.1.2 Bar scheduling

Bars should be scheduled in accordance with the acceptable standards. Where reinforcement is to fit between two concrete faces, the permissible deviations recommended in clause 8.1.3 should be adopted.

8.1.3 Permissible deviations on reinforcement fitting between two concrete faces

The overall dimension on the bending schedule should be determined for this reinforcement as the nominal dimension of the concrete less the nominal cover on each face and less the deduction for permissible deviation on member size and on bending given in Table 8.1.

| Difference between concrete faces m | Type of bar | Total Deduction mm |
|--|------------------------|-----------------------|
| 0 to 1 | Links and bent up bars | 10 |
| Above 1 to 2 | Links and bent up bars | 15 |
| Over 2 | Links and bent up bars | 20 |
| All | Straight bars | 40 |

Table 8.1 - Bar Schedule Dimensions: deduction for permissible deviations

8.2 SPACING OF REINFORCEMENT

The spacing of bars shall be such that the concrete can be placed and compacted satisfactorily for the development of adequate bond.

The clear distance (horizontal and vertical) between individual parallel bars or horizontal layers of parallel bars should be not less than the maximum of bar diameter, ($h_{agg} + 5$ mm) or 20 mm where h_{agg} is the maximum size of aggregate.

Where bars are positioned in separate horizontal layers, the bars in each layer should be located vertically above each other. There should be sufficient space between the resulting columns of bars to allow access for vibrators and good compaction of concrete.

Lapped bars may be allowed to touch one another within the lap length. See section 8.7 for more details.

8.3 PERMISSIBLE INTERNAL RADII FOR BENT BARS

The minimum radius to which a bar is bent shall be such as to avoid bending cracks in the bar, and to avoid failure of the concrete inside the bends of the bar.

Table 8.2 gives minimum values for bend radii to avoid cracks in reinforcement due to bending. These values may be used without causing concrete failure if one of the following conditions is fulfilled (ϕ is the diameter of bent bar):

- (a) the anchorage of the bar does not require a length more than 4ϕ past the end of the bend;
- (b) where the bar is assumed not to be stressed beyond a point 4ϕ past the end of the bend at ultimate limit state; or
- (c) there is a cross bar of diameter $\geq \phi$ inside the bend. The cross bar shall extend for at least 3ϕ length on both side of the bend.

| Bar diameter | Minimum internal bend radius for hooks and loops |
|---------------------------|--|
| $\phi \leq 12 \text{ mm}$ | 2ϕ |
| $\phi < 20 \text{ mm}$ | 3ϕ |
| $\phi \geq 20 \text{ mm}$ | 4ϕ |

Table 8.2 - Minimum bend radii to avoid damage to reinforcement

In no case should the minimum bend radius be less than twice the radius of the test bend guaranteed by the manufacturer of the bar, nor less than the radius required to ensure that the bearing stress at the mid-point of the curve does not exceed the values given below.

If none of the conditions above are fulfilled, the design bearing stress inside the bend should be checked to avoid concrete failure. The design bearing stress should be calculated from the following equation:

$$\text{bearing stress} = \frac{F_{bt}}{r\phi} \leq \frac{2f_{cu}}{\left(1 + 2\frac{\phi}{a_b}\right)} \quad 8.1$$

where:

F_{bt} is the tensile force from ultimate loads in a bar or group of bars in contact at the start of a bend,

r is the internal radius of the bend,

a_b for a given bar (or group of bars in contact) is the centre-to-centre distance between bars (or group of bars) perpendicular to the plane of the bend. For a bar or group of bars adjacent to the face of the member, a_b should be taken as the cover plus ϕ .

Note: The equation includes an allowance for $\gamma_m = 1.5$.

8.4 ANCHORAGE OF LONGITUDINAL REINFORCEMENT

8.4.1 General

Reinforcing bars, wires or welded fabrics should be so anchored that the bond forces are safely transmitted to the concrete avoiding longitudinal cracking or spalling. Transverse reinforcement shall be provided if necessary.

At both sides of any cross-section the forces in each bar should be developed by an appropriate embedment length or other end anchorage. Provided this is done, local bond stress may be ignored.

Where anchorage devices are used, their effectiveness shall be proven by tests and their capacity to transmit the concentrated forces at the anchorage shall be demonstrated.

For the transmission of prestressing forces to the concrete, see section 8.10.

8.4.2 Anchorage bond stress

Anchorage bond stress is assumed to be constant over the effective anchorage length. It may be taken as the force in the bar divided by its effective surface anchorage area (see clause 8.4.3). It should not exceed the appropriate value obtained from clause 8.4.4.

8.4.3 Design anchorage bond stress

The design anchorage bond stress f_b is assumed to be constant over the anchorage length and is given by the following equation:

$$f_b = F_s / (\pi\phi l_b) \quad 8.2$$

where:

- F_s is the force in the bar or group of bars
- ϕ is the effective bar size which, for a single bars is the bar size and for a group of bars in contact is equal to the diameter of a bar of equal total area.

8.4.4 Values for design ultimate anchorage bond stress

Values for design ultimate anchorage bond stress f_{bu} may be obtained from the equation:

$$f_{bu} = \beta \sqrt{f_{cu}} \quad 8.3$$

where:

- f_{cu} is the characteristic compressive cube strength of concrete, limited to 60 N/mm² for the purpose of calculating ultimate anchorage bond stress,
- f_{bu} is the design ultimate anchorage bond stress,
- β is a coefficient dependent on the bar type.

For bars in tension in slabs or in beams where minimum links have been provided in accordance with Table 6.2, the values of β may be taken from Table 8.3. These values include a partial safety factor γ_m of 1.4

| Bar type | β | |
|----------------------------------|-----------------|---------------------|
| | Bars in tension | Bars in compression |
| Plain bars | 0.28 | 0.35 |
| Ribbed bars | 0.50 | 0.63 |
| Welded fabric (see clause 8.4.6) | 0.65 | 0.81 |

Table 8.3 - Values of bond coefficient β

In beams where minimum links in accordance with Table 6.2 have not been provided, the design anchorage bond stresses used should be those appropriate to plain bars irrespective of the type of bar used. This does not apply to slabs.

8.4.5 Minimum ultimate anchorage bond lengths

The ultimate anchorage bond length l_b should be greater than or equal to the value calculated from:

$$l_b \geq f_s \phi / (4f_{bu}) \quad 8.4$$

where:

$$f_s \text{ is } 0.87f_y$$

Values for anchorage bond lengths are given in Table 8.4 as multiples of bar diameter.

| Concrete Grade | Type of anchorage length | Reinforcement types | | |
|----------------|--------------------------|--------------------------------|--------------------------------|---------------|
| | | f_y 250 N/mm ² | f_y 500 N/mm ² | |
| | | | Ribbed | Welded fabric |
| 30 | Tension | 36 | 40 | 31 |
| | Compression | 29 | 32 | 25 |
| 35 | Tension | 33 | 38 | 29 |
| | Compression | 27 | 30 | 23 |
| 40 | Tension | 31 | 35 | 27 |
| | Compression | 25 | 28 | 22 |
| 45 | Tension | 29 | 33 | 25 |
| | Compression | 24 | 26 | 20 |
| 50 | Tension | 28 | 31 | 24 |
| | Compression | 22 | 25 | 19 |
| ≥ 60 | Tension | 26 | 28 | 22 |
| | Compression | 20 | 23 | 18 |

Table 8.4 - Ultimate anchorage bond lengths (l_b) as multiples of bar diameter

8.4.6 Anchorage by bend or hook

End anchorages in the form of hooks and bends should only be used to meet specific design requirements and should conform to the acceptable standards.

Bends and hooks do not contribute to compression anchorages.

Concrete failure inside bends should be prevented by complying with section 8.3, however, should anchorage of the bar require a length more than 4ϕ beyond the end of the bend the design bearing stress inside the bend must be checked.

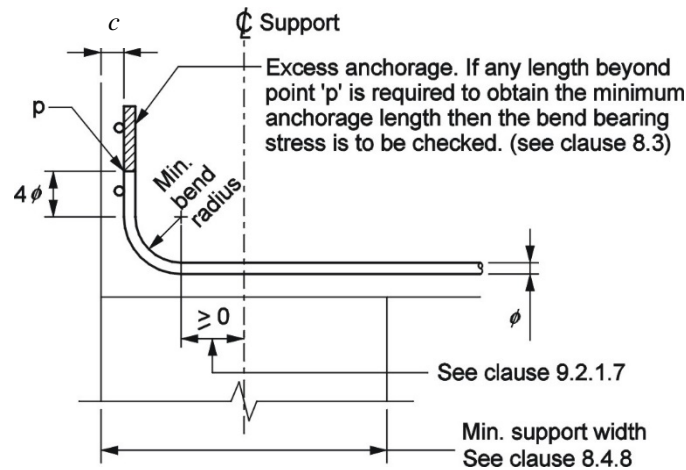

Figure 8.1 - Requirements of a bend anchorage

8.4.7 Design ultimate anchorage bond stress for welded fabric

The value of design ultimate anchorage bond stress given in clause 8.4.4 for welded fabric is applicable to fabric manufactured from bars or wires conforming to the acceptable standards. This is provided that:

- (a) the welded fabric is welded in a shear resistance manner conforming to the acceptable standards; and
- (b) the number of welded intersections within the anchorage length is at least equal to $4A_s \text{ req} / A_s \text{ prov}$.

When the second condition is not satisfied, the anchorage bond stress should be taken as that appropriate to the individual bars or wires in the sheet.

8.4.8 Minimum support widths

Supports in the form of beams, columns and walls etc. should have a minimum width of:

$2(3\phi + c)$ for anchored bars less than or equal to 12 mm in diameter, or 8.5a

$2(4\phi + c)$ for anchored bars larger than 12 mm but less than 20 mm in diameter, or 8.5

$2(5\phi + c)$ for anchored bars 20 mm or larger in diameter. 8.6

See Figure 8.1 for notation.

8.5 ANCHORAGE OF LINKS AND SHEAR REINFORCEMENT

The anchorage of links and shear reinforcement should normally be effected by means of bends and hooks, or by welded transverse reinforcement. A longitudinal bar of at least the size of the link should be provided inside a hook or bend.

The anchorage should comply with Figure 8.2. Welding should be carried out in accordance with the acceptable standards and have a welding capacity in accordance with clause 8.6.

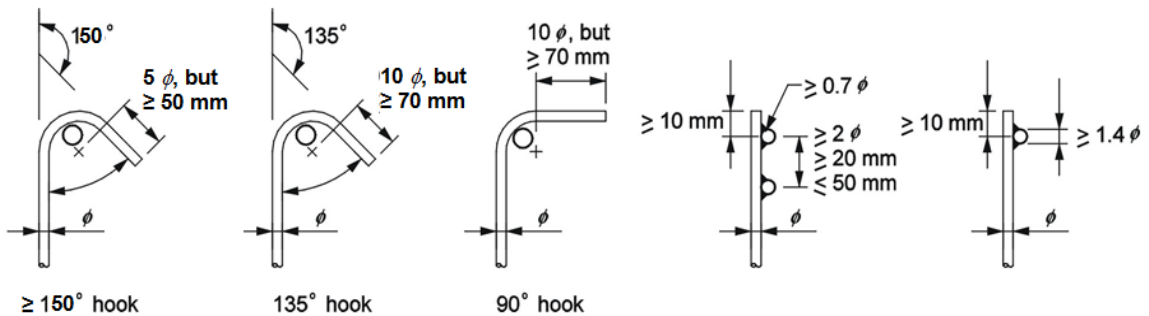

Figure 8.2 - Anchorage of links

In no case should the radius of any bend in the link be less than twice the radius of a test bend guaranteed by the manufacturer of the bar.

8.6 ANCHORAGE BY WELDED BARS

The anchorage should comply with sections 8.4 and 8.5. Additional anchorage may be obtained by transverse welded bars (see Figure 8.3) bearing on the concrete. The quality of the welded joints should be shown to be adequate.

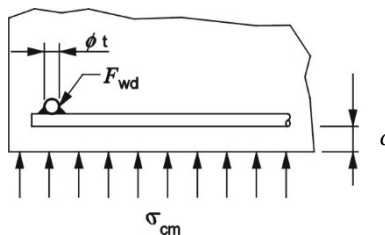

Figure 8.3 - Welded transverse bar as anchoring device

The anchorage capacity of one such welded transverse bar (diameter 14 mm – 32 mm), F_{btd} , may be calculated as follows:

$$F_{\text{btd}} = l_{\text{td}} \phi_t \sigma_{\text{td}} \text{ but not greater than } F_{\text{wd}} \quad 8.7$$

where:

F_{wd} is the design shear strength of weld (specified as a factor times $A_s f_{\text{yd}}$, say $0.5 A_s f_{\text{yd}}$ where A_s is the cross-section of the anchored bar and f_{yd} is its design yield strength),

l_{td} is the design length of transverse bar: $l_{\text{td}} = 1.16 \phi (f_{\text{yd}} / \sigma_{\text{td}})^{0.5} \leq l_t$,

l_t is the length of transverse bar, but not more than the spacing of bars to be anchored,

ϕ_t is the diameter of transverse bar,

σ_{td} is the concrete stress; $\sigma_{\text{td}} = \sigma_{\text{cm}} / y \leq 2.4 f_{\text{cu}}$,

σ_{cm} is the compression stress in the concrete perpendicular to both bars (mean value, positive for compression),

y is the function: $y = 0.015 + 0.14 e^{(-0.18x)}$,

x is the function accounting for the geometry: $x = 2(c / \phi_t) + 1$,

c is the concrete cover perpendicular to both bars,

f_s in clause 8.4.5 may then be reduced taking into account F_{btd} .

If two bars of the same size are welded on opposite sides of the bar to be anchored, the capacity given by equation 8.7 should be doubled.

If two bars are welded to the same side with a minimum spacing of 3ϕ , the capacity should be multiplied by a factor of 1.4.

For nominal bar diameters of 12 mm and less, the anchorage capacity of a welded cross bar is mainly dependent on the design strength of the welded joint. The anchorage capacity of a welded cross bar for size of maximum 12 mm may be calculated as follows:

$$F_{\text{btd}} = F_{\text{wd}} \leq 16 A_s f_{\text{cd}} \phi_t / \phi \quad 8.8$$

where:

F_{wd} is the design shear strength of weld (see equation 8.7),

ϕ_t is the nominal diameter of transverse bar: $\phi_t \leq 12$ mm,

ϕ is the nominal diameter of bar to anchor: $\phi \leq 12$ mm.

If two welded cross bars with a minimum spacing of ϕ_t are used, the anchorage length given by equation 8.7 should be multiplied by a factor of 1.4.

8.7 LAPS

8.7.1 General

Forces are transmitted from one bar to another by:

- lapping of bars, with or without bends or hooks;
- welding; or
- mechanical devices assuring load transfer in tension and/or compression.

In joints where imposed loading is predominantly cyclical bars should not be joined by welding.

8.7.2 Laps

The detailing of laps between bars shall be such that:

- (a) the transmission of the forces from one bar to the next is assured;
- (b) spalling of the concrete in the neighbourhood of the joints does not occur; and
- (c) large cracks which affect the performance of the structure do not occur.

Laps between bars should normally be staggered and not located in areas of high stress. Laps at any one section should normally be arranged symmetrically. At laps, the sum of the diameters of all the reinforcement bars in a particular layer should not exceed 40% of the breadth of the section at that level.

The arrangement of lapped bars should comply with Figure 8.4:

- (d) the clear transverse distance between two lapping bars should not be greater than 4ϕ or 50 mm, otherwise the lap length should be increased by a length equal to the clear space exceeding 4ϕ or 50 mm, whichever is lesser;
- (e) the longitudinal distance between two adjacent laps should not be less than 0.3 times the lap length, l_0 ; and
- (f) in case of adjacent laps, the clear distance between adjacent bars should not be less than 2ϕ or 20 mm, whichever is greater.

The permissible percentage of lapped bars in tension at any section may be 100% where the bars are all in one layer, or 50% where the bars are in 2 or more layers.

All bars in compression and secondary (distribution) reinforcement may be lapped in one section.

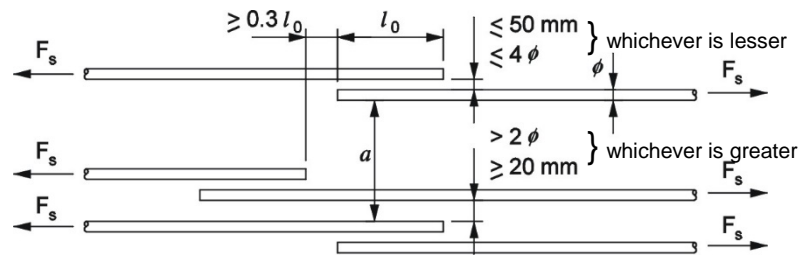

Figure 8.4 - Adjacent laps

8.7.3 Lap length

8.7.3.1 Minimum lap length

The minimum lap length for bar reinforcement should be not less than 15 times the bar diameter or 300 mm, whichever is greater, and for welded fabric should not be less than 250 mm.

8.7.3.2 Tension lap length

The tension lap length should be at least equal to the design tension anchorage length (see clause 8.4.5) necessary to develop the required stress in the reinforcement. Lap lengths for unequal size bars (or wires in welded fabric) may be based upon the diameter of the smaller bar. The following provisions also apply:

- (a) where a lap occurs at the top of a section as cast and the minimum cover is less than twice the diameter of the lapped reinforcement, the lap length should be increased by a factor of 1.4;
- (b) where a lap occurs at a corner of a section and the minimum cover to either face is less than twice the diameter of the lapped reinforcement or, where the clear distance between adjacent laps (see dimension a in Figure 8.4) is less than 75 mm or 6 times the size of the lapped reinforcement, whichever is the greater, the lap length should be increased by a factor of 1.4; and
- (c) where both conditions above apply, the lap length should be increased by a factor of 2.0.

The above conditions representing factors to be applied to the basic lap length are illustrated in Figure 8.5, and values for lap lengths are given in Table 8.5 as multiples of bar diameter.

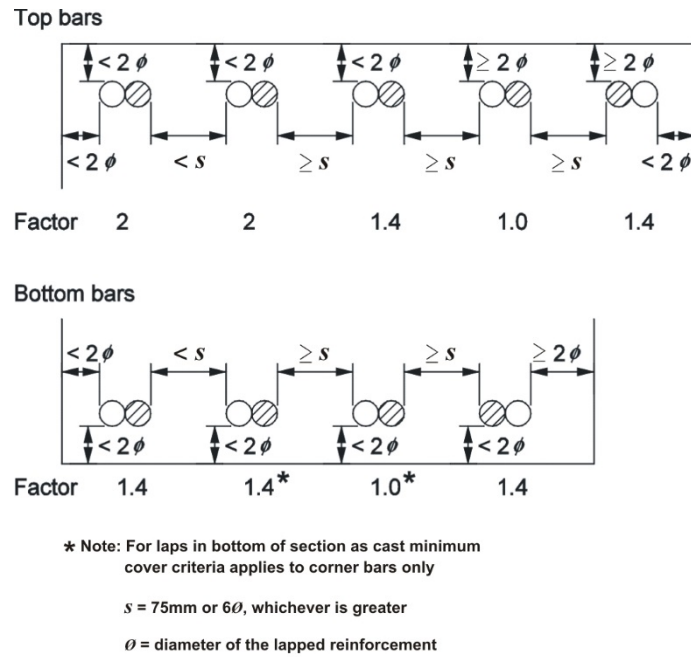

Figure 8.5 - Factors for lapping bars

8.7.3.3 Compression lap length

The compression lap length should be at least 25% greater than the design compression anchorage length (see clause 8.4.5) necessary to develop the required stress in the reinforcement. Lap lengths for unequal size bars (or wires in welded fabric) may be based upon the smaller bar diameter.

Values for lap lengths are given in Table 8.5 as multiples of bar diameter.

| Concrete Grade | Type of lap length | Reinforcement types | | |
|---|--|--------------------------------|--------------------------------|---------------|
| | | f_y 250 N/mm ² | f_y 500 N/mm ² | |
| | | | Ribbed | Welded fabric |
| 30 | Tension and compression lap length – l_o | 36 | 40 | 31 |
| | 1.4 x tension lap | 50 | 56 | 44 |
| | 2.0 x tension lap | 71 | 80 | 62 |
| 35 | Tension and compression lap length – l_o | 33 | 38 | 29 |
| | 1.4 x tension lap | 46 | 52 | 40 |
| | 2.0 x tension lap | 66 | 75 | 57 |
| 40 | Tension and compression lap length – l_o | 31 | 35 | 27 |
| | 1.4 x tension lap | 43 | 49 | 38 |
| | 2.0 x tension lap | 62 | 70 | 54 |
| 45 | Tension and compression lap length – l_o | 29 | 33 | 25 |
| | 1.4 x tension lap | 41 | 47 | 35 |
| | 2.0 x tension lap | 58 | 66 | 50 |
| 50 | Tension and compression lap length – l_o | 28 | 31 | 24 |
| | 1.4 x tension lap | 39 | 44 | 34 |
| | 2.0 x tension lap | 55 | 62 | 48 |
| ≥ 60 | Tension and compression lap length – l_o | 26 | 28 | 22 |
| | 1.4 x tension lap | 36 | 40 | 31 |
| | 2.0 x tension lap | 51 | 56 | 44 |
| Notes: | | | | |
| 1. The values are rounded up to the nearest whole number and the length derived from these values may differ slightly from those calculated directly for each bar or wire size. | | | | |

Table 8.5 - Ultimate lap lengths as multiples of bar diameter

8.7.4 Transverse reinforcement in the lap zone

8.7.4.1 Transverse reinforcement for bars in tension

Transverse reinforcement is required in the lap zone to resist transverse tension forces.

Where the diameter, ϕ , of the lapped bars is less than 20 mm, or the percentage of lapped bars in any one section is less than 25%, then any transverse reinforcement or links necessary for other reasons may be assumed sufficient for the transverse tensile forces without further justification.

Where the diameter, ϕ , of the lapped bars is greater than or equal to 20 mm, the transverse reinforcement should have a total area, A_{st} (sum of all legs parallel to the layer of the spliced reinforcement) of not less than the area A_s of one spliced bar ($\Sigma A_{st} \geq 1.0A_s$). It should be placed perpendicular to the direction of the lapped reinforcement and between that and the surface of the concrete.

If more than 50% of the reinforcement is lapped at one point and the distance, a , between adjacent laps at a section is $\leq 10\phi$ (see Figure 8.4) transverse bars should be formed by links or U bars anchored into the body of the section. This transverse reinforcement should be positioned at the outer sections of the lap as shown in Figure 8.6 (a).

8.7.4.2 Transverse reinforcement for bars permanently in compression

In addition to the rules for bars in tension one bar of the transverse reinforcement should be placed outside each end of the lap length and within 4ϕ of the ends of the lap length (see Figure 8.6 (b)).

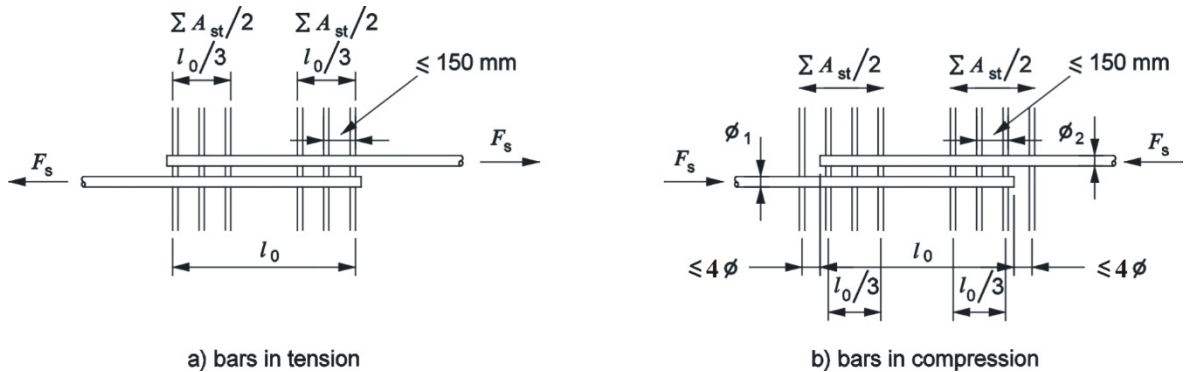

Figure 8.6 - Transverse reinforcement for lapped splices

8.8 ADDITIONAL RULES FOR LARGE DIAMETER BARS

For bars of diameter, $\phi > 40$ mm, the following rules supplement those given in sections 8.4 and 8.7.

When such large diameter bars are used, crack control may be achieved either by using surface reinforcement or by calculation (see clause 7.2.3).

Splitting forces are higher and dowel action is greater with the use of large diameter bars. Such bars should be anchored with mechanical devices. If anchored as straight bars, link should be provided as confining reinforcement.

Generally large diameter bars should not be lapped. Exceptions include sections with a minimum dimension of 1.0 m or where the stress is not greater than 80% of the design ultimate strength.

Transverse compression reinforcement, additional to that provided for shear, should be provided in the anchorage zones where transverse compression is not present.

For straight anchorage lengths the additional transverse reinforcement referred to above should not be less than the following:

in the direction parallel to the tension face:

$$A_{sh} = 0.25A_s n_1$$

in the direction perpendicular to the tension face:

$$A_{sv} = 0.25A_s n_2$$

where:

A_s denotes the cross sectional area of an anchored bar,

n_1 is the number of layers with bars anchored at the same point in the member,

n_2 is the number of bars anchored in each layer.

Example: In Figure 8.7a, $n_1 = 1$, $n_2 = 2$ and in 8.7b $n_1 = 2$, $n_2 = 2$

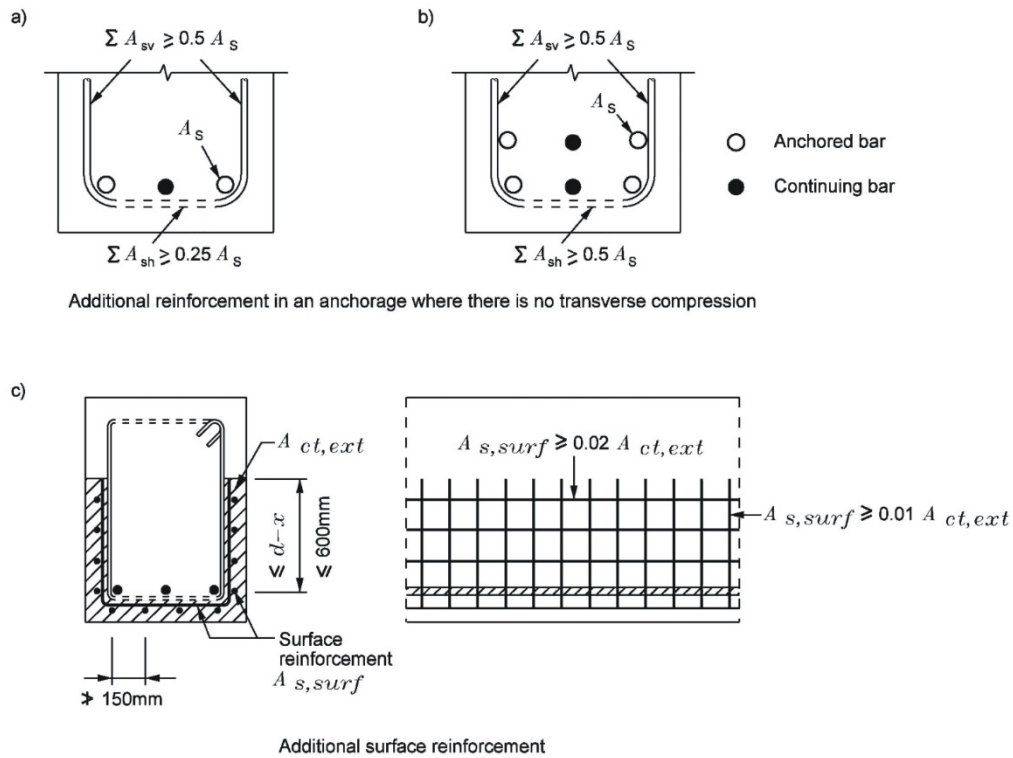

Figure 8.7 - Additional reinforcement for large diameter bars

The additional transverse reinforcement should be uniformly distributed in the anchorage zone and the spacing of bars should not exceed 5 times the diameter of the longitudinal reinforcement.

Surface reinforcement should be provided when large diameter bars are present, but the area of surface reinforcement should not be less than $0.01 A_{ct,ext}$ in the direction perpendicular to large diameter bars, and $0.02 A_{ct,ext}$ parallel to those bars.

$A_{ct,ext}$ denotes the area of the tensile concrete external to the links, defined by Figure 8.7c.

8.9 BUNDLED BARS

8.9.1 General

Unless otherwise stated, the rules for individual bars also apply for bundles of bars. In a bundle, all the bars should be of the same characteristics (type and grade). Bars of different sizes may be bundled provided that the ratio of diameters does not exceed 1.7.

In design, the bundle is replaced by a notional bar having the same sectional area and the same centre of gravity as the bundle. The equivalent diameter, ϕ_n of this notional bar is such that:

$$\phi_n = \phi \sqrt{n_b} \leq 55 \text{ mm} \quad 8.9$$

where:

n_b is the number of bars in the bundle, which is limited to:

- (a) $n_b \leq 4$ for vertical bars in compression and for bars in a lapping joint; and
- (b) $n_b \leq 3$ for all other cases.

For a bundle, the rules given in clause 8.2 for spacing of bars apply. The equivalent diameter, ϕ_n , should be used but the clear distance between bundles should be measured from the actual external contour of the bundle of bars. The concrete cover should be measured from the actual external of the bundles and should not be less than ϕ_n .

Where two touching bars are positioned one above the other, and where the bond conditions are good, such bars need not be treated as a bundle.

8.9.2 Anchorage of bundles of bars

Bundles of bars in tension may be curtailed over end and intermediate supports. Bundles with an equivalent diameter < 32 mm may be curtailed near a support without the need for staggering bars. Bundles with an equivalent diameter ≥ 32 mm which are anchored near a support should be staggered in the longitudinal direction as shown in Figure 8.8.

Where individual bars are anchored with a staggered distance greater than $1.3 l_b$ (where l_b is based on the bar diameter), the diameter of the bar may be used in assessing the anchorage length (see Figure 8.8). Otherwise the equivalent diameter of the bundle, ϕ_n , should be used.

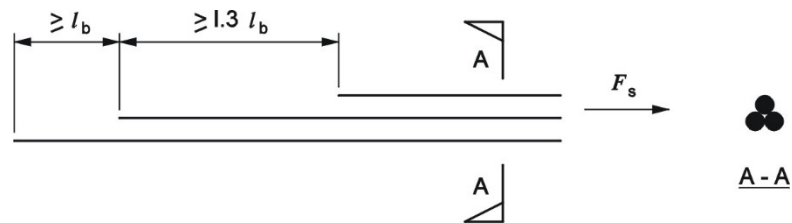

Figure 8.8 - Anchorage of widely staggered bars in a bundle

For compression anchorages bundled bars need not be staggered. For bundles with an equivalent diameter ≥ 32 mm, at least four links having a diameter ≥ 12 mm should be provided at the ends of the bundle. A further link should be provided just beyond the end of the curtailed bar.

8.9.3 Lapping bundles of bars

The lap length should be calculated in accordance with clause 8.7.3 using ϕ_n from equation 8.9 as the equivalent bar diameter.

For bundles which consist of two bars with an equivalent diameter < 32 mm the bars may be lapped without staggering individual bars. In this case the equivalent bar size should be used to calculate l_0 .

For bundles which consist of two bars with an equivalent diameter ≥ 32 mm or of three bars, individual bars should be staggered in the longitudinal direction by at least $1.3 l_0$ as shown in Figure 8.9. For this case the diameter of a single bar may be used to calculate l_0 . Care should be taken to ensure that there are not more than four bars in any lap cross section.

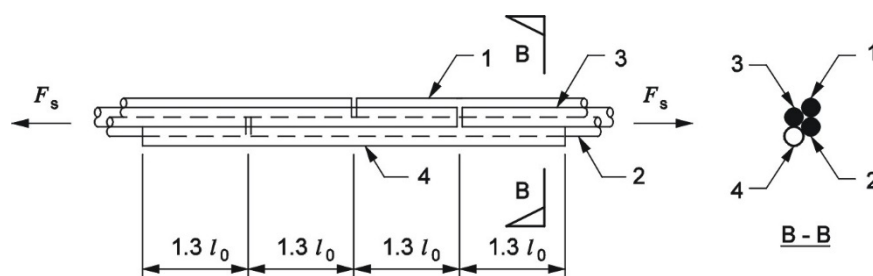

Figure 8.9 - Lap joint in tension including a fourth bar

8.10 PRESTRESSING TENDONS

8.10.1 Arrangement of prestressing tendons and ducts

The spacing of ducts or of pre-tensioned tendons shall be such as to ensure that placing and compacting of the concrete can be carried out satisfactorily and that sufficient bond can be attained between the concrete and the tendons.

8.10.1.1 Pre-tensioned tendons

The minimum clear horizontal and vertical spacing of individual pre-tensioned tendons should be in accordance with that shown in Figure 8.10. Other layouts may be used provided that test results show satisfactory ultimate behaviour with respect to:

- (a) the concrete in compression at the anchorage;
- (b) the spalling of concrete;
- (c) the anchorage of pre-tensioned tendons; and
- (d) the placing of the concrete between the tendons.

Consideration should also be given to durability and the danger of corrosion of the tendon at the end of elements.

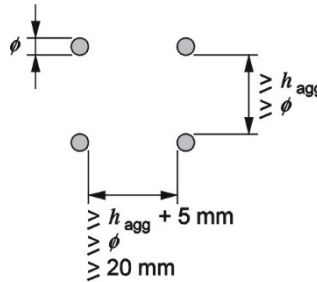

Figure 8.10 - Minimum clear spacing between pre-tensioned tendons

Bundling of tendons should not occur in the anchorage zones, unless placing and compacting of the concrete can be carried out satisfactorily and sufficient bond can be attained between the concrete and the tendons.

8.10.1.2 Post-tension ducts

- (a) General

The ducts for post-tensioned tendons shall be located and constructed so that:

- (i) the concrete can be safely placed without damaging the ducts;
- (ii) the concrete can resist the forces from the ducts in the curved parts during and after stressing; and
- (iii) no grout will leak into other ducts during grouting process.

Ducts for post-tensioned members, should not normally be bundled except in the case of a pair of ducts placed vertically one above the other.

The minimum clear spacing between ducts should be in accordance with that shown in Figure 8.11.

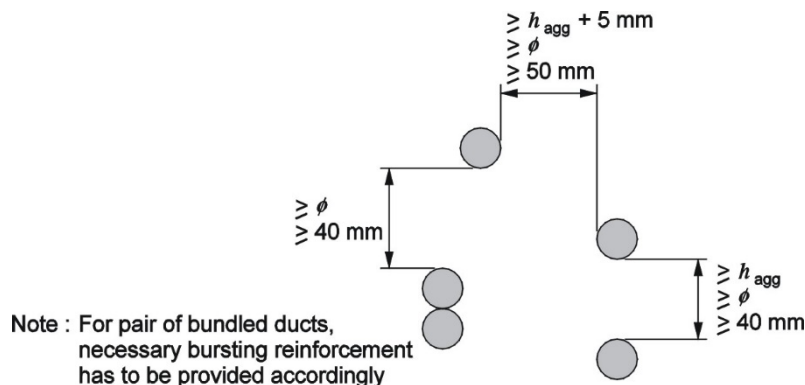

Figure 8.11 - Minimum clear spacing between ducts

(b) Curved tendons and ducts

Where curved tendons are used in post-tensioning, the positioning of the tendon ducts should be such as to prevent:

- (i) bursting of the side cover perpendicular to the plane of curvature of the ducts;
- (ii) bursting of the cover in the plane of curvature of the ducts; and
- (iii) crushing of the concrete separating ducts in the same plane of curvature.

In the absence of detailed calculations the following rules may be applied.

In order to prevent bursting of the cover perpendicular to the plane of curvature, the cover should be in accordance with the values given in Table 8.6. Bursting reinforcement should also be provided. Where tendon profilers or spacers are provided in the ducts, and these are of a type which will concentrate the radial force, the values in Table 8.6 will need to be increased. The cover for a given combination of duct internal diameter and radius of curvature shown in Table 8.6 may be reduced pro rata with the square root of the tendon force when this is less than the value tabulated, subjected to a minimum of 50 mm.

When the curved tendons run close to and approximately parallel to the surface of the member and the tendon develops radial forces perpendicular to the exposed surface of the concrete, the ducts should be restrained by stirrup reinforcement anchored into the members.

In order to prevent crushing of the concrete between ducts minimum spacing should be as follows:

- (iv) in the plane of curvature – the distance given in Table 8.7 or the distance given in clause 8.10.1.2 (a), whichever is the greater; or
- (v) perpendicular to the plane of curvature – the distance given in clause 8.10.1.2 (a).

The distance for a given combination of duct internal diameter and radius of curvature shown in Table 8.7 may reduce pro rata with the tendon force when this is less than the value tabulated, subjected to the recommendations of 8.10.1.2 (a).

Exceptionally, to achieve minimum spacing of ducts it may be possible to tension and grout first the tendon having the least radius of curvature, and to allow an interval of 48 hours to elapse before tensioning the next tendon. In this case the spacing recommendations given in 8.10.1.2 (a) apply.

| Radius of Curvature of duct (m) | Duct internal diameter (mm) | | | | | | | | | | | | | | | | |
|---------------------------------|-----------------------------|-----|-----|------|------|------|------|------|------|------|------|------|------|-------|-------|-------|-----|
| | 19 | 30 | 40 | 50 | 60 | 70 | 80 | 90 | 100 | 110 | 120 | 130 | 140 | 150 | 160 | 170 | |
| | Tendon force (kN) | | | | | | | | | | | | | | | | |
| | 296 | 387 | 960 | 1337 | 1920 | 2640 | 3360 | 4320 | 5183 | 6019 | 7200 | 8640 | 9424 | 10388 | 11248 | 13200 | |
| | Tendon force (mm) | | | | | | | | | | | | | | | | |
| 2 | 50 | 55 | 155 | 220 | 320 | 445 | | | | | | | | | | | |
| 4 | | 50 | 70 | 100 | 145 | 205 | 265 | 350 | 420 | | | | | | | | |
| 6 | | | 50 | 65 | 90 | 125 | 165 | 220 | 265 | 310 | 375 | 460 | | | | | |
| 8 | | | | 55 | 75 | 95 | 115 | 150 | 185 | 220 | 270 | 330 | 360 | 395 | | | |
| 10 | | | | 50 | 65 | 85 | 100 | 120 | 140 | 165 | 205 | 250 | 275 | 300 | 330 | | |
| 12 | | | | | 60 | 75 | 90 | 110 | 125 | 145 | 165 | 200 | 215 | 240 | 260 | 315 | |
| 14 | | | | | 55 | 70 | 85 | 100 | 115 | 130 | 150 | 170 | 185 | 200 | 215 | 260 | |
| 16 | | | | | 55 | 65 | 80 | 95 | 110 | 125 | 140 | 160 | 175 | 190 | 205 | 225 | |
| 18 | | | | | 50 | 65 | 75 | 90 | 105 | 115 | 135 | 150 | 165 | 180 | 190 | 215 | |
| 20 | | | | | | 60 | 70 | 85 | 100 | 110 | 125 | 145 | 155 | 170 | 180 | 205 | |
| 22 | | | | | | | 55 | 70 | 80 | 95 | 105 | 120 | 140 | 150 | 160 | 175 | 195 |
| 24 | | | | | | | 55 | 65 | 80 | 90 | 100 | 115 | 130 | 145 | 155 | 165 | 185 |
| 26 | | | | | | | 50 | 65 | 75 | 85 | 100 | 110 | 125 | 135 | 150 | 160 | 180 |
| 28 | | | | | | | | 60 | 75 | 85 | 95 | 105 | 120 | 130 | 145 | 155 | 170 |
| 30 | | | | | | | | 60 | 70 | 80 | 90 | 105 | 120 | 130 | 140 | 150 | 165 |
| 32 | | | | | | | | 55 | 70 | 80 | 90 | 100 | 115 | 125 | 135 | 145 | 160 |
| 34 | | | | | | | | 55 | 65 | 75 | 85 | 100 | 110 | 120 | 130 | 140 | 155 |
| 36 | | | | | | | | 55 | 65 | 75 | 85 | 95 | 110 | 115 | 125 | 140 | 150 |
| 38 | | | | | | | | 50 | 60 | 70 | 80 | 90 | 105 | 115 | 125 | 135 | 150 |
| 40 | | | | | | | | 50 | 60 | 70 | 80 | 90 | 100 | 110 | 120 | 130 | 145 |

Notes:

1. The tendon force shown is the maximum normally available for the given size of duct. (Taken as 80% of the characteristic strength of the tendon.)

Table 8.6 - Minimum cover to ducts perpendicular to plane of curvature

| Radius of Curvature of duct (m) | Duct internal diameter (mm) | | | | | | | | | | | | | | | |
|---------------------------------|-----------------------------|-----|-----|------|------|------|------|------|------|------|------|-------|------|-------|-------|-------|
| | 19 | 30 | 40 | 50 | 60 | 70 | 80 | 90 | 100 | 110 | 120 | 130 | 140 | 150 | 160 | 170 |
| | Tendon force (kN) | | | | | | | | | | | | | | | |
| | 296 | 387 | 960 | 1337 | 1920 | 2640 | 3360 | 4320 | 5183 | 6019 | 7200 | 8640 | 9424 | 10388 | 11248 | 13200 |
| | Tendon force (mm) | | | | | | | | | | | | | | | |
| 2 | 110 | 140 | 350 | 485 | 700 | 960 | | | | | | | | | | |
| 4 | 55 | 70 | 175 | 245 | 350 | 480 | 610 | 785 | 940 | | | | | | | |
| 6 | 38 | 60 | 120 | 165 | 235 | 320 | 410 | 525 | 630 | 730 | 870 | 1 045 | | | | |
| 8 | | | 90 | 125 | 175 | 240 | 305 | 395 | 470 | 545 | 655 | 785 | 855 | 940 | | |
| 10 | | | 80 | 100 | 140 | 195 | 245 | 315 | 375 | 440 | 525 | 630 | 685 | 750 | 815 | |
| 12 | | | | | 120 | 160 | 205 | 265 | 315 | 365 | 435 | 525 | 570 | 625 | 680 | 800 |
| 14 | | | | | | 140 | 175 | 225 | 270 | 315 | 375 | 450 | 490 | 535 | 585 | 785 |
| 16 | | | | | | | 160 | 195 | 235 | 275 | 330 | 395 | 430 | 470 | 510 | 600 |
| 18 | | | | | | | | 180 | 210 | 245 | 290 | 350 | 380 | 420 | 455 | 535 |
| 20 | | | | | | | | | 200 | 220 | 265 | 315 | 345 | 375 | 410 | 480 |
| 22 | | | | | | | | | | | 240 | 285 | 310 | 340 | 370 | 435 |
| 24 | | | | | | | | | | | | 265 | 285 | 315 | 340 | 400 |
| 26 | | | | | | | | | | | | 260 | 280 | 300 | 320 | 370 |
| 28 | | | | | | | | | | | | | | | | 345 |
| 30 | | | | | | | | | | | | | | | | 340 |
| 32 | | | | | | | | | | | | | | | | |
| 34 | | | | | | | | | | | | | | | | |
| 36 | | | | | | | | | | | | | | | | |
| 38 | | | | | | | | | | | | | | | | |
| 40 | 38 | 60 | 80 | 100 | 120 | 140 | 160 | 180 | 200 | 220 | 240 | 260 | 280 | 300 | 320 | 340 |

Notes:

- The tendon force shown is the maximum normally available for the given size of duct. (Taken as 80% of the characteristic strength of the tendon.)
- Values less than twice the internal duct diameter are not included.

Table 8.7 - Minimum distance between centrelines of ducts in plane of curvature

8.10.2 Anchorage of pre-tensioned tendons

8.10.2.1 General

The recommendations of clause 8.10.1.1 concerning minimum spacing of bonded tendons apply. As anchorage is achieved by bond, the spacing of the wires or strands in the ends of the members should be such as to allow the transmission lengths given in 8.10.2.2 to be developed. In addition if the tendons are positioned in two or more widely spaced groups, the possibility of longitudinal splitting of the members should be considered.

8.10.2.2 Transfer of prestress

(a) General

The transmission or anchorage length is defined as the length of the member required to transmit the initial prestressing force in a tendon to the concrete.

(b) Factor affecting the transmission length

The most important of these factors are:

- (i) the degree of compaction of the concrete;
- (ii) the size and type of the tendon;
- (iii) the strength of the concrete; and
- (iv) the deformation and surface condition of the tendon.

Where tendons are prevented from bonding to the concrete near the ends of the units by the use of sleeves or tape, the transmission lengths should be taken from the ends of the de-bonded portions.

The transmission lengths for tendons near the top of units may well be greater than those for identical tendons placed lower in the unit since the concrete near the top is less likely to be as well compacted and may produce water bleeding problem.

The sudden release of tendons leads to a considerable increase in the transmission lengths near the release position.

In case of combined ordinary and pre-tensioned reinforcement, the anchorage capacities of both may be added.

(c) Assessment of transmission length

For calculating the transmission length l_t in the absence of experimental evidence, the following equation may be used for initial prestressing forces up to 75% of the characteristic strength of the tendon when the ends of the units are fully compacted:

$$l_t = \frac{K_t \phi}{\sqrt{f_{ci}}} \quad 8.10$$

where:

f_{ci} is the concrete strength at transfer,

ϕ is the nominal diameter of the tendon,

K_t is a coefficient for the type of tendon and is selected from the following:

$K_t = 600$ for plain or indented wire (including crimped wire with a small wave height);

$K_t = 400$ for crimped wire with a total wave height not less than 0.15ϕ ;

$K_t = 240$ for 7-wire standard or super strand; and

$K_t = 360$ for 7-wire drawn strand.

8.10.3 Anchorage zones of post-tensioned members

The design of anchorage zones should be in accordance with the application rules given in this section. The design strength of transverse ties and reinforcement should be limited in accordance with clauses 3.2 and 3.3.

When considering the effects of the prestress as a concentrated force on the anchorage zone, the design value of the prestressing tendons should be in accordance with clause 2.3.2.2 and the lower characteristic tensile strength of the concrete should be used.

The bearing stress behind anchorage plates should be checked in accordance with the relevant European Technical Approval.

Tensile forces due to concentrated forces should be assessed by a strut and tie model, or other appropriate representation (see clause 6.5). Reinforcement should be detailed assuming that it acts at its design strength. If the stress in this reinforcement is limited to 300 N/mm² no check of crack widths is necessary.

As a simplification the prestressing force may be assumed to disperse at an angle of spread 2β (see Figure 8.12), starting at the end of the anchorage device, where β may be assumed to be $\arctan 2/3$.

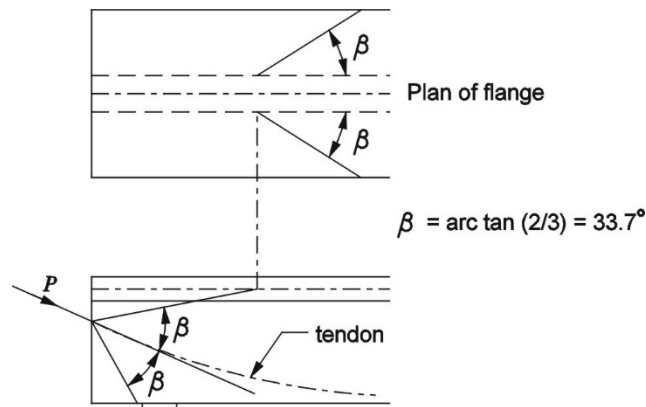

Figure 8.12 - Dispersion of prestress

8.10.4 Anchorages and couplers for prestressing tendons

The anchorage devices used for post-tensioned tendons shall be in accordance with those specified for the prestressing system, and the anchorage lengths in the case of pre-tensioned tendons shall be such as to enable the full design strength of the tendons to be developed, taking account of any repeated, rapidly changing action effects.

Where couplers are used they shall be in accordance with those specified for the prestressing system and shall be so placed, taking account of the interference caused by these devices, that they do not affect the bearing capacity of the member and that any temporary anchorage which may be needed during construction can be introduced in a satisfactory manner.

Calculations for local effects in the concrete and for the transverse reinforcement should be made in accordance section 8.10.3.

In general, couplers should be located away from intermediate supports.

The placing of couplers on 50% or more of the tendons at one cross-section should be avoided unless it can be shown that a higher percentage will not cause more risk to the safety of the structure.

8.10.5 Deviators

A deviator shall satisfy the following requirements:

- (a) withstand both longitudinal and transverse forces that the tendon applies to it and transmit these forces to the structure; and
- (b) ensure that the radius of curvature of the prestressing tendon does not cause any overstressing or damage to it.

In the deviation zones the tubes forming the sheaths shall be able to sustain the radial pressure and longitudinal movement of the prestressing tendon, without damage and without impairing its proper functioning.

The radius of curvature of the tendon in a deviation zone shall be in accordance with the acceptable standards.

Designed tendon deviations up to an angle of 0.01 radian may be permitted without using a deviator. The forces developed by the change of angle using a deviator should be taken into account in the design calculations.

9 DETAILING OF MEMBERS AND PARTICULAR RULES

9.1 GENERAL

The detailing requirements for safety, serviceability and durability are satisfied by following the rules given in this section in addition to the general rules given in section 8.

The detailing of members should be consistent with the design models adopted.

Minimum areas of reinforcement are given in order to prevent a brittle failure, wide cracks and also to resist forces arising from restrained actions.

Detailing of members should normally comply with both the general detailing rules given in clauses 9.2 to 9.8 and the particular rules for ductility given in clause 9.9. However, members not contributing in the lateral load resisting system or walls for single storey structures do not need to conform to the requirements of clause 9.9.

9.2 BEAMS

9.2.1 Longitudinal reinforcement

9.2.1.1 Minimum percentages of reinforcement

The minimum percentages of reinforcement appropriate for various conditions of loading are given in Table 9.1.

Sections containing less reinforcement than that given by Table 9.1 should be considered as unreinforced.

9.2.1.2 Side bars for beams exceeding 750 mm overall depth.

The minimum size of longitudinal bars in side faces of beams to control cracking should be not less than $\sqrt{(s_b b / f_y)}$ where s_b is the bar spacing and b the breadth of the section at the point considered, or 500 mm if b exceeds 500 mm.

The spacing should not exceed 250 mm and the bars should be distributed over a distance of two-thirds of the beam's overall depth measured from its tension face.

9.2.1.3 Maximum areas of reinforcement

Neither the area of tension reinforcement nor the area of compression reinforcement should exceed 4% of the gross cross-sectional area of the concrete.

At laps, the sum of the diameter of all reinforcement bars in a particular layer should not exceed 40% of the breadth of the section at that location.

9.2.1.4 Maximum distance between bars in tension

The clear horizontal distance between adjacent bars, or groups, near the tension face of a beam should not be greater than:

$$\text{clear spacing} \leq 70\,000 \beta_b f_y \leq 300 \text{ mm} \quad 9.1$$

where:

β_b is the redistribution ratio:

$$\frac{\text{moment at the section after redistribution}}{\text{moment at the section before redistribution}} \text{ from the respective maximum moments diagram.}$$

Alternatively, the clear spacing may be assessed from the relationship:

$$\text{clear spacing} \leq 47\,000 / f_s \leq 300 \text{ mm} \quad 9.2$$

where:

f_s is the estimated service stress in the reinforcement and may be obtained from:

$$f_s = \frac{2 f_y A_{s, \text{req}}}{3 A_{s, \text{prov}}} \times \frac{1}{\beta_b} \quad 9.3$$

The distance between the face of the beam and the nearest longitudinal bar in tension should not be greater than half the clear distance determined above.

| Situation | Definition of percentage | Minimum percentage | |
|--|---------------------------------------|--|--|
| | | $f_y = 250$ N/mm ² (%) | $f_y = 500$ N/mm ² (%) |
| <i>Tension reinforcement</i> Sections subjected mainly to pure tension Sections subjected to flexure: | $100A_S/A_C$ | $0.8\alpha_{min}$ | $0.45\alpha_{min}$ |
| (i) flanged beams, web in tension: $b_W/b < 0.4$ $b_W/b \geq 0.4$ | $100A_S/b_W h$ $100A_S/b_W h$ | $0.32\alpha_{min}$ $0.24\alpha_{min}$ | $0.18\alpha_{min}$ $0.13\alpha_{min}$ |
| (ii) flanged beams, flange in tension: T-beam L-beam | $100A_S/b_W h$ $100A_S/b_W h$ | $0.48\alpha_{min}$ $0.36\alpha_{min}$ | $0.26\alpha_{min}$ $0.20\alpha_{min}$ |
| (iii) rectangular section | $100A_S/A_C$ | $0.24\alpha_{min}$ | $0.13\alpha_{min}$ |
| <i>Compression reinforcement</i> (where such reinforcement is required for the ultimate limit state) General rule | $100A_{SC}/A_{CC}$ | 0.4 | 0.4 |
| Simplified rules for particular cases: (i) rectangular beam | $100A_{SC}/A_C$ | 0.2 | 0.2 |
| (ii) flanged beam flange in compression web in compression | $100A_{SC}/bh_f$ $100A_{SC}/b_W h$ | 0.4 0.2 | 0.4 0.2 |
| <i>Transverse reinforcement in flanges of flanged beams</i> (provided over full effective flange width near top surface to resist horizontal shear) | $100 A_{St}/h_f l$ | $0.15\alpha_{min}$ | $0.15\alpha_{min}$ |
| Notes: 1. The minimum percentages of reinforcement should be increased where necessary to meet the ductility requirements given in clause 9.9. 2. $\alpha_{min} = 40f_{cu}^{2/3}/f_y$ but not less than 1.0. | | | |

Table 9.1 - Minimum percentages of reinforcement

9.2.1.5 Other detailing arrangements

In monolithic construction, even when simple supports have been assumed in design, the section at supports should be designed for a bending moment arising from partial fixity of at least 15% of the maximum bending in the span.

(Note, the minimum area of longitudinal reinforcement defined in clause 9.2.1.1 applies.)

At intermediate supports of continuous beams, the total area of tension reinforcement A_S of a flanged cross-section may be spread over the effective width of flange (see clause 5.2.1.2 (a)) provided that at least 85% of A_S is placed within the web width (see Figure 9.1)

9.2.1.6 Curtailment of tension reinforcement

Except at end supports (see clause 9.2.1.7) in every flexural member every bar should extend beyond the point at which in theory it is no longer needed, for a distance at least equal to the greater of:

- (a) the effective depth of the member; or

- (b) 12 times the bar diameter.

In addition for a bar in the tension zone, one of the following distances for all arrangements of design ultimate load should be considered:

- (c) an anchorage length appropriate to its design strength ($0.87f_y$) from the point at which it is no longer required to assist in resisting the bending moment; or
- (d) to the point where the design shear capacity of the section is greater than twice the design shear force at that section; or
- (e) to the point where other bars continuing past that point provide double the area required to resist the design bending moment at that section.

The point at which a bar is no longer required is the point where the design resistance moment of the section, considering only the continuing bars, is equal to the design moment.

As curtailment of substantial areas of reinforcement at a single section can lead to the development of large cracks at that point, it is therefore advisable to stagger the curtailment points in heavily reinforced members.

Cantilever extensions should also comply with the requirements given in clause 9.4.

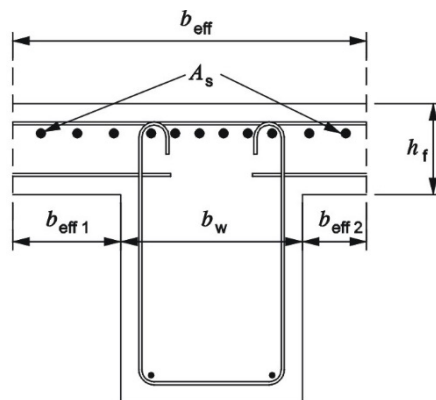

Note: At least 85% of A_s shall be placed within b_w

Figure 9.1 - Placing of tension reinforcement in flanged cross-section

9.2.1.7 Anchorage of bars at a simply-supported end of a beam

At a simply-supported end of a member half the calculated mid-span bottom reinforcement should be anchored by one of the following:

- (a) an effective anchorage length equivalent to 12 times the bar diameter beyond the centre-line of the support. No bend or hook should begin before the centre of the support; or
- (b) an effective anchorage length equivalent to 12 times the bar diameter plus $d/2$ from the face of the support, where d is the effective depth of member. No bend or hook should begin before $d/2$ from the face of the support.

9.2.1.8 Anchorage of bottom reinforcement at internal supports

At an intermediate support of a continuous member 30% of the calculated mid-span bottom reinforcement should be continuous through the support.

9.2.1.9 Containment of compression reinforcement

The recommendations given in clause 9.5.2 for columns will apply also to beams.

9.2.2 Shear reinforcement

The shear reinforcement may consist of a combination of:

- (a) links enclosing the longitudinal tension reinforcement and the compression zone;
- (b) bent-up bars; and
- (c) cages or ladders (see Figure 9.2) which are cast in without enclosing the longitudinal reinforcement but are properly anchored in the compression and tension zones.

Links should be effectively anchored in accordance with clause 8.5. A lap joint on the leg near the surface of the web is permitted provided that the link is not required to resist torsion.

At least 50% of the necessary shear reinforcement should be in the form of links.

The minimum area of shear reinforcement for the whole length of a beam is given by:

$$A_{sv} \geq v_r b_v s_v / (0.87 f_{yv}) \tag{9.4}$$

where v_r is defined in Table 6.2.

The maximum spacing of the links in the direction of the span should not exceed $0.75d$. At right-angles to the span, the horizontal spacing should be such that no longitudinal tension bar is more than 150 mm from a vertical leg.

The longitudinal spacing of bent-up bars (see Figure 6.2) should not exceed $s_{b,max}$, as given by equation 9.5.

$$s_{b,max} = 0.6d(1 + \cot \alpha) \tag{9.5}$$

where:

α is the inclination of the bent-up bars to the longitudinal axis.

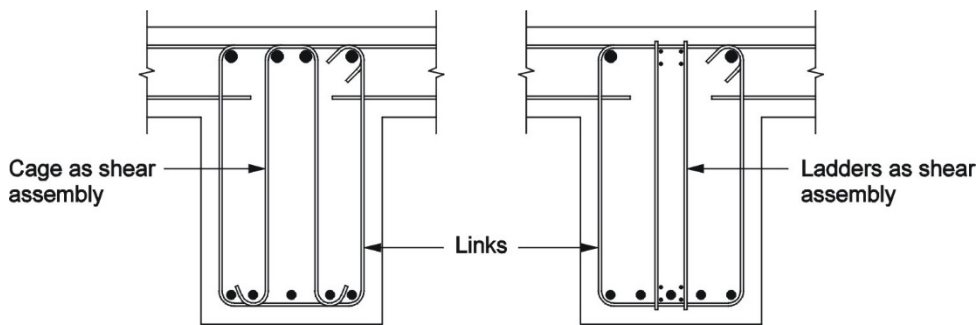
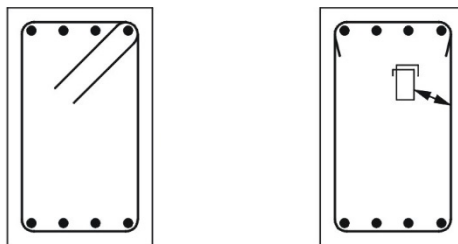

Figure 9.2 - Examples of shear reinforcement

9.2.3 Torsion reinforcement

Torsion links should be closed and be anchored by means of laps or hooked ends, see Figure 9.3, and should form an angle of 90° with the axis of the structural element. Where there is adequate confinement to prevent the end anchorage of the link from “kick off”, alternative anchor details may be used.

Torsion reinforcement should comply with the provisions of clauses 6.3.5 to 6.3.9.



Full tension anchorage to be provided for the torsion link (See Figure 8.2)

Figure 9.3 - Torsion link arrangements

9.3 SOLID SLABS

This section applies to one-way and two-way solid slabs.

9.3.1 Flexural reinforcement

9.3.1.1 General

(a) Minimum reinforcement

The following minimum percentages of total longitudinal reinforcement should be provided in each direction:

- (i) $f_y = 250 \text{ N/mm}^2$: 0.24% of concrete cross-sectional area; and
- (ii) $f_y = 500 \text{ N/mm}^2$: 0.13% of concrete cross-sectional area.

For tension reinforcement, the minimum percentages of total longitudinal reinforcement should be multiplied by a modification factor, $\alpha_{\min} = 40f_{cu}^{2/3}/f_y$ but not less than 1.0.

Generally secondary transverse reinforcement of not less than 20% of the principal reinforcement should be provided in one-way slabs. In areas near supports transverse reinforcement to principal top bars is not necessary where there is no transverse bending moment.

(b) Reinforcement spacing

The maximum spacing of bars should comply with the following requirements:

- (i) for the principal reinforcement, $3h \leq 400 \text{ mm}$; and
- (ii) for the secondary reinforcement, $3.5h \leq 450 \text{ mm}$.

In areas with concentrated loads or areas of maximum moment those provisions become respectively:

- (iii) for the principal reinforcement, $2h \leq 250 \text{ mm}$; and
- (iv) for the secondary reinforcement, $3h \leq 400 \text{ mm}$.

In addition, unless crack widths are checked by direct calculation, the following rules will ensure adequate control of cracking for slabs subjected to normal internal and external environments:

No further check is required on bar spacing if either:

- (v) $h \leq 250 \text{ mm}$ (grade 250 steel);
- (vi) $h \leq 200 \text{ mm}$ (grade 500 steel); or
- (vii) the percentage of required tension reinforcement ($100A_s/bd$) is less than 0.3%.

Where none of these three conditions apply, the bar spacings should be limited to the values calculated in clause 9.2.1.4 for slabs where the required reinforcement percentage exceeds 1% or the values calculated in clause 9.2.1.4 divided by the reinforcement percentage for percentage less than 1.

In slabs where the amount of redistribution is unknown, β_b may be assumed to be minus 15% for support moments and zero for span moments.

When reinforcement is needed to distribute cracking arising from shrinkage and temperature effects, the recommendations given in clause 9.6.5 for plain walls should be followed.

9.3.1.2 Curtailment of tension reinforcement

Curtailing and anchoring reinforcement may be carried out in accordance with clause 9.2.1.6 for beams.

9.3.1.3 Reinforcement at end supports

In simply supported slabs or end support of continuous slabs, half the calculated span reinforcement should be anchored into the support in accordance with section 8.4 and the provisions of clause 9.2.1.7 for beams.

If the design ultimate shear stress at the face of the support is less than half the appropriate value, v_c , recommended in clause 6.1.2.5, a straight length of bar beyond the centreline of the support equal to either one-third of the support width or 30 mm, whichever is the greater may be considered as effective anchorage.

Negative moments due to partial fixity may arise which could lead to cracking. To control this, an amount of top reinforcement capable of resisting at least 50% of the maximum mid-span moment, but not less than the minimum given in clause 9.3.1.1, should be provided at the support. It should have a full effective tensile anchorage into the support and extend not less than $0.15l$ or 45 times the bar diameter into the span.

9.3.1.4 Bottom reinforcement internal supports

At an intermediate support of a slab 40% of the calculated mid-span bottom reinforcement should be continuous through the support.

9.3.1.5 Corner reinforcement

If the detailing arrangements at a support are such that lifting of the slab at a corner is restrained, suitable reinforcement should be provided. See clause 6.1.3.3(c) and (d).

9.3.1.6 Reinforcement at free edges

Along a free (unsupported) edge, a slab should normally contain longitudinal and transverse reinforcement, generally arranged as shown in Figure 9.4.

The normal reinforcement provided for a slab may act as edge reinforcement.

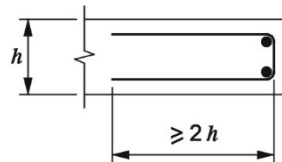

Figure 9.4 - Edge reinforcement for a slab

9.3.2 Shear reinforcement

Shear reinforcement, if required for solid slabs, ribbed slabs and flat slabs, should comply with the provisions of clauses 6.1.3.5, 6.1.4.4 or 6.1.5.7 as appropriate.

It is difficult to bend and fix shear reinforcement and assure its effectiveness in slabs less than 200 mm thick. Therefore, shear reinforcement should not be used in such slabs.

9.4 CANTILEVERED PROJECTING STRUCTURES

9.4.1 General requirements

Instead of pure cantilevered slab arrangements, beam-and-slab arrangements should be used for spans exceeding 1200 mm. When these requirements cannot be complied with, more stringent control than those given in this Code may be necessary.

A cantilevered structure should have such a thickness that the following requirements and the requirements of clause 7.3 are complied with:

- 300 mm at the support of cantilevered beam;
- 110 mm for cantilevered slab with span not exceeding 500 mm;
- 125 mm for cantilevered slab with span greater than 500 mm but not exceeding 750 mm;
- 150 mm for cantilevered slab with span greater than 750 mm but not exceeding 1000 mm;
- 175 mm for cantilevered slab with span exceeding 1000 mm but not exceeding 1200 mm.

Cantilevered structures should be reinforced with ribbed steel reinforcing bars. Cantilevered slabs should have reinforcing bars in both faces and in both directions.

Cantilevered structures exposed to weathering should be provided with:

- means to prevent accumulation of water;
- effective waterproofing;
- adequate fall which should not be less than 1:75; and
- an effective drainage system.

Cantilevered slabs exposed to weathering should be designed for:

- exposure condition 2 or higher if appropriate; and

- (k) estimated maximum crack width not exceeding 0.1 mm under serviceability limit state or the stress of deformed high yield steel reinforcing bars used should not exceed 100 N/mm² when checking the flexural tension under the working load condition.

Where a wall is designed to support a cantilevered slab, it should have adequate thickness and rigidity to provide the rotational restraint and to resist the cantilevered moment.

9.4.2 Minimum reinforcement

The minimum percentage of top tension longitudinal reinforcement based on the gross cross-sectional concrete area should be 0.25% for all reinforcement grades but not less than that stipulated in clause 9.3.1.1(a). The minimum diameter of this principal reinforcement should be 10 mm.

For areas of minimum reinforcement at other locations within a projecting structure refer to sections 9.2 or 9.3 as appropriate.

The centre-to-centre spacing of the top tension longitudinal bars should not be more than 150 mm.

9.4.3 Anchorage of tension reinforcement

A full anchorage length should be provided for the top tension reinforcement of a cantilevered projecting structure.

Where full rotational restraint is provided at the near face of the supporting member, i.e. the face at which the bar enters the supporting member, the anchorage shall be deemed to commence at 1/2 the width of the supporting member or 1/2 the effective depth of the cantilevered projecting structure whichever is less, from the near face of the supporting member.

Where the cantilevered projecting structure is a continuous slab or beam and the support is not designed to provide rotational restraint in the analysis of the continuous structure, the anchorage shall be deemed to commence at the far face of the supporting member, and the top reinforcement should not terminate before the nearest point of contraflexure in the adjacent spans. No reduction in anchorage bond length due to actual bar stress shall be permitted. See section 1.4 for definition of a cantilevered projecting structure.

9.4.4 Details and construction

Cantilevered structures, especially those projecting over streets, should be detailed in such a manner that they may be demolished or replaced without affecting the safety and integrity of the main structure of the building.

Cantilevered structures should be cast monolithically with and at the same time as the directly supporting members. Construction joints should not be located along the external edge of the supporting members. In case this is unavoidable, the construction method should ensure that the finished product should have a structural strength and integrity not inferior to that provided by monolithic construction, and should not invite ingress of water through the joint.

Adequate bar spacers should be provided to maintain the position and alignment of the steel reinforcing bars. Every endeavour should be made to avoid steel reinforcing bars from being displaced or depressed. Concrete works should strictly comply with requirements stipulated in clause 10.3

Where a wall is designed to support a cantilevered slab, it should have adequate thickness to allow the proper anchorage of the main reinforcing bars of the cantilevered slab.

External cantilevered slabs with a span exceeding 750 mm exposed to weathering should satisfy the following requirements:

- (a) concrete should be water-proof concrete of characteristic compressive strength not less than 35 MPa at 28 days;
- (b) all main steel reinforcing bars should be hot-dip galvanized to BS EN ISO 1461; and
- (c) water-proof membrane/tanking should be provided and protected by 1:3 cement sand mortar of 0.65 maximum free water/cement ratio or other equivalent means.

9.5 COLUMNS

This clause deals with columns for which the larger dimension is not greater than 4 times the smaller dimension.

9.5.1 Longitudinal reinforcement

The area of total longitudinal reinforcement based on the gross cross-sectional area of a column should not be less than 0.8%. See clause 9.9.2 for ductility requirement.

Bars should have a diameter of not less than 12 mm.

The minimum number of longitudinal bars in a column should be four in rectangular columns and six in circular columns. In columns having a polygonal cross-section, at least one bar should be placed at each corner.

The longitudinal reinforcement should not exceed the following amounts, calculated as percentages of the gross cross-sectional area of the concrete:

- (a) vertically-cast columns - 6%;
- (b) horizontally-cast columns - 8%; and
- (c) laps in vertically-or horizontally-cast columns - 10%.

At laps, the sum of the reinforcement sizes in a particular layer should not exceed 40% of the breadth of the section at that location.

9.5.2 Transverse reinforcement

9.5.2.1 General

The diameter of the transverse reinforcement (links, loops or helical spiral reinforcement) should not be less than 6 mm or $\frac{1}{4}$ the diameter of the largest longitudinal bar, whichever is the greater. The diameter of wires or welded fabric when used for transverse reinforcement should not be less than 5 mm.

The spacing of transverse reinforcement along a column should not exceed the least of the following:

- (a) 12 times the diameter of the smallest longitudinal bar;
- (b) the lesser dimension of the column;
- (c) 400 mm.

Where the direction of the column longitudinal bars change, (e.g. at changes in column size), the spacing of transverse reinforcement should be calculated, taking account of the lateral forces involved. These effects may be ignored if the change of direction is less than or equal to 1 in 12.

9.5.2.2 Rectangular or polygonal columns

All corner bars, and alternate bars (or bundle) in an outer layer of reinforcement should be supported by links, with or without crossties, passing around the bars and having an included angle of not more than 135° (see Figure 9.5a). No bar within a compression zone should be further than 150 mm from a restrained bar.

Links should be adequately anchored by means of hooks bent through an angle of not less than 135° (see Figure 9.5b). Crossties should be adequately anchored by means of hooks bent through an angle of not less than 135° at one end and 90° at the other end, and should be alternated end for end along the longitudinal bars (see Figure 9.5d). Where there is adequate confinement to prevent the end anchorage of the link from "kick off" (see Figure 9.5e), hooks with bend not less than 135° in the links or crossties may be replaced by other standard hooks given in Figure 8.2.

9.5.2.3 Circular columns

Spiral transverse reinforcement should be anchored by either welding to the previous turn, in accordance with clause 8.7, or by terminating the spiral with at least a 90° hook bent around a longitudinal bar and the hook being no more than 25 mm from the previous turn.

Circular links should be anchored by either a mechanical connection or welded lap, in accordance with clause 8.7, or by terminating each end of the link with at least a 90° hook bent around a longitudinal bar and overlapping the other end of the link (see Figure 9.5c).

Spiral or circular links should not be anchored by straight lapping.

9.5.2.4 Alternative details

Alternative arrangement of column transverse reinforcement is given in Figure 9.5f.

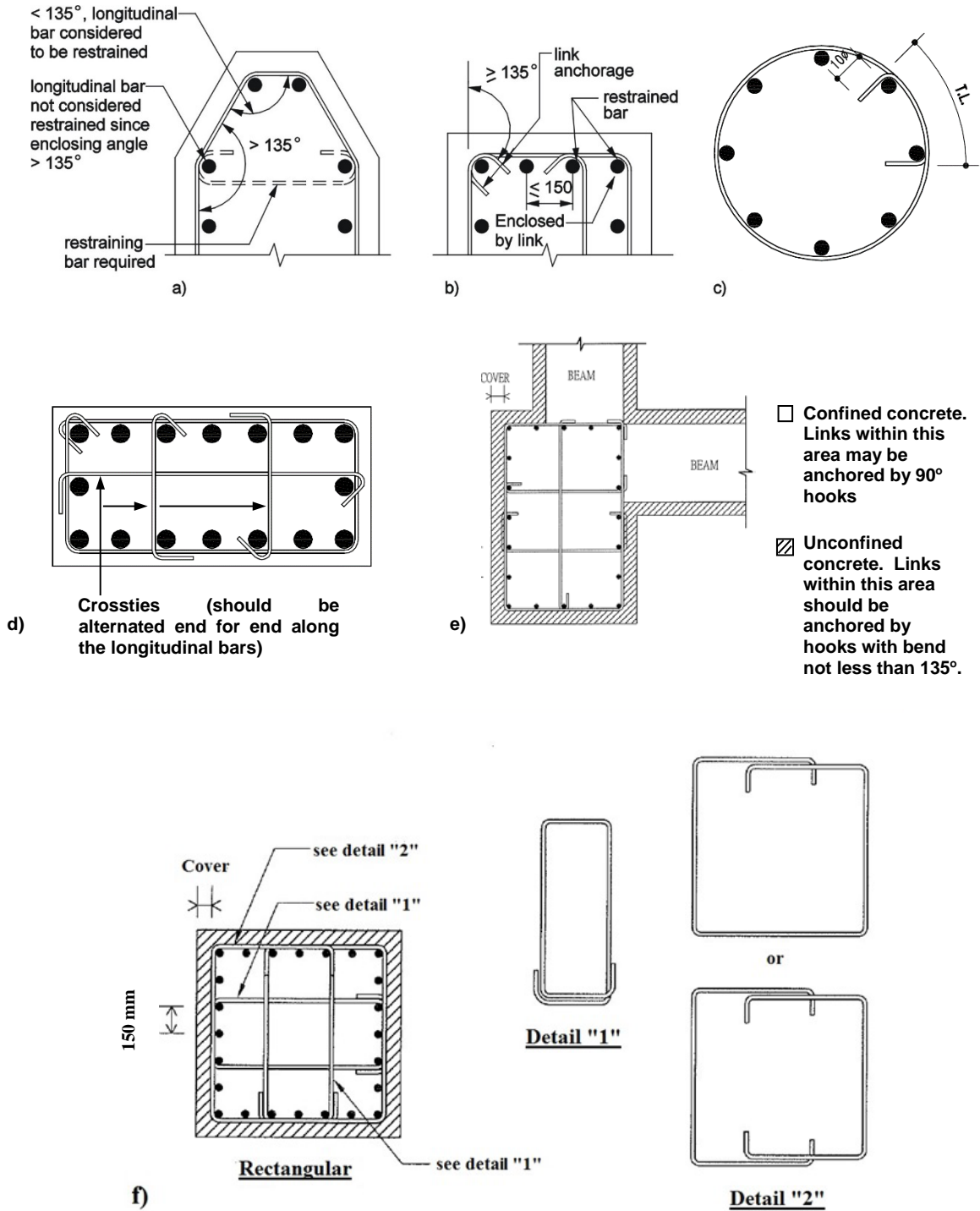

Figure 9.5 - Column transverse reinforcement

9.6 WALLS

9.6.1 General

This clause refers to reinforced concrete walls with a length to thickness ratio of 4 or more and in which the reinforcement is taken into account in the strength analysis. For walls subjected predominantly to out-of-plane bending the rules for slabs apply (see section 9.3).

9.6.2 Vertical reinforcement

The minimum percentage of vertical reinforcement based on the concrete cross-sectional area of a wall is 0.4%. Where this minimum area of reinforcement controls in the design, half of the area should be located at each face.

The area of vertical reinforcement should not exceed 4% of the concrete cross-sectional area of a wall. This limit may be doubled at laps.

The distance between two adjacent vertical bars shall not exceed 3 times the wall thickness or 400 mm whichever is the lesser.

9.6.3 Horizontal reinforcement

Where the main vertical reinforcement is used to resist compression and does not exceed 2% of the concrete area, at least the following percentages of horizontal reinforcement should be provided, depending upon the characteristic strength of that reinforcement:

(a) $f_y = 250 \text{ N/mm}^2$: 0.30% of concrete cross-sectional area; and

(b) $f_y = 500 \text{ N/mm}^2$: 0.25% of concrete cross-sectional area.

These horizontal bars should be evenly spaced at no more than 400 mm. The diameter should be not less than one-quarter of the size of the vertical bars and not less than 6 mm.

9.6.4 Transverse reinforcement

When the vertical compression reinforcement exceeds 2%, links at least 6 mm or one-quarter the size of the largest compression bar should be provided through the thickness of the wall. The spacing of links should not exceed twice the wall thickness in either the horizontal or vertical direction. In the vertical direction it should be not greater than 16 times the bar diameter. All vertical compression bars should be enclosed by a link. No bar should be further than 200 mm from a restrained bar, at which a link passes round the bar with an included angle of not more than 90°.

9.6.5 Plain walls

Reinforcement may be needed in plain walls to control cracking due to flexure or thermal and hydration shrinkage. Wherever provided, the minimum quantity of reinforcement in each direction should be at least:

(a) $f_y = 250 \text{ N/mm}^2$: 0.30% of concrete cross-sectional area; and

(b) $f_y = 500 \text{ N/mm}^2$: 0.25% of concrete cross-sectional area.

If necessary in walls exceeding 2 m in length and exposed to the weather, reinforcement should be provided in both horizontal and vertical directions. It should consist of small diameter bars, relatively closely spaced, with adequate cover.

For internal plain walls it may be sufficient to provide reinforcement only at that part of the wall where junctions with floors and beams occur. When provided it should be dispersed half near each face.

Nominal reinforcement around openings should be considered.

9.7 FOUNDATIONS

9.7.1 Pile caps

The distance from the outer edge of the pile to the edge of the pile cap should be such that the forces in the pile cap can be properly anchored. The expected deviation of the pile on site should be taken into account.

The main tensile reinforcement to resist the action effects should be concentrated in the stress zones between the tops of the piles. If the area of this reinforcement is at least equal to the minimum reinforcement, evenly distributed bars along the bottom surface of the member may be omitted. Also the sides and the top surface of the member may be unreinforced if there is no risk of tension developing in these parts of the members. The minimum reinforcement as shown in Table 9.1 should be observed.

Welded transverse bars may be used for the anchorage of the tension reinforcement. In this case the transverse bar may be considered to be part of the transverse reinforcement in the anchorage zone of the reinforcement bar considered.

The compression caused by the support reaction from the pile may be assumed to spread at 45° degree angles from the edge of the pile. This compression may be taken into account when calculating the anchorage length.

The compression bond stresses that develop on starter bars within bases or pile caps need not be checked provided:

- (a) the starter bars extend down to the level of the bottom reinforcement;
- (b) the pile cap base has been designed for moments and shear in accordance with section 6.7.

9.7.2 Column and wall footings

The main reinforcement should be anchored in accordance with the requirements of sections 8.4 and 8.5.

If the action effects cause tension at the upper surface of the footing, the resulting tensile stresses should be checked and reinforced as necessary.

The minimum reinforcement as shown in Table 9.1 should be observed.

9.7.3 Tie beams

Tie beams may be used to reduce the eccentricity of loading of the foundations. The beams should be designed to resist the resulting bending moments and shear forces.

Tie beams should also be designed for a minimum downward load of 10 kN/m if the action of compaction machinery can cause effects to the beams.

9.7.4 Bored piles and barrettes

The longitudinal reinforcement should comply with the following requirements:

- (a) not less than the minimum A_{sc} given in Table 9.2;
- (b) not smaller than 16 mm in diameter and not less than 6 in number;
- (c) centre-to-centre spacing not exceeding 400 mm; and
- (d) extended for at least one full anchorage length into the pile cap.

The transverse reinforcement should comply with the requirements given in clause 9.5.2.

Nominal cover to all reinforcement should not be less than 75 mm.

| Pile cross-sectional area A_c | Minimum A_{sc} |
|--|-----------------------|
| < 0.5 m ² | 0.5% A_c |
| 0.5 m ² to 1.0 m ² | 0.0025 m ² |
| > 1.0 m ² | 0.25% A_c |

Table 9.2 - Minimum A_{sc} for bored piles and barrettes

9.8 CORBELS

9.8.1 General

The design of corbels may be based on strut-and-tie models provided that equilibrium and strength requirements are satisfied. The horizontal link requirement of clause 9.8.3 will ensure satisfactory serviceability performance.

9.8.2 Reinforcement anchorage

At the front face of the corbel, the primary reinforcement should be anchored either by:

- (a) welding to a transverse bar of equal strength and diameter. In this case the bearing area of the load should stop short of the transverse bar by a distance equal to the cover of the tie reinforcement; or
- (b) bending back the bars to form a loop. In this case the bearing area of the load should not project beyond the straight portion of the bars forming the main tension reinforcement.

9.8.3 Shear reinforcement

Shear reinforcement should be provided in the form of horizontal links distributed in the upper $\frac{2}{3}$ of the effective depth of the root of the corbel. This reinforcement should not be less than half the area of the main tension reinforcement and should be adequately anchored (see Figure 9.6).

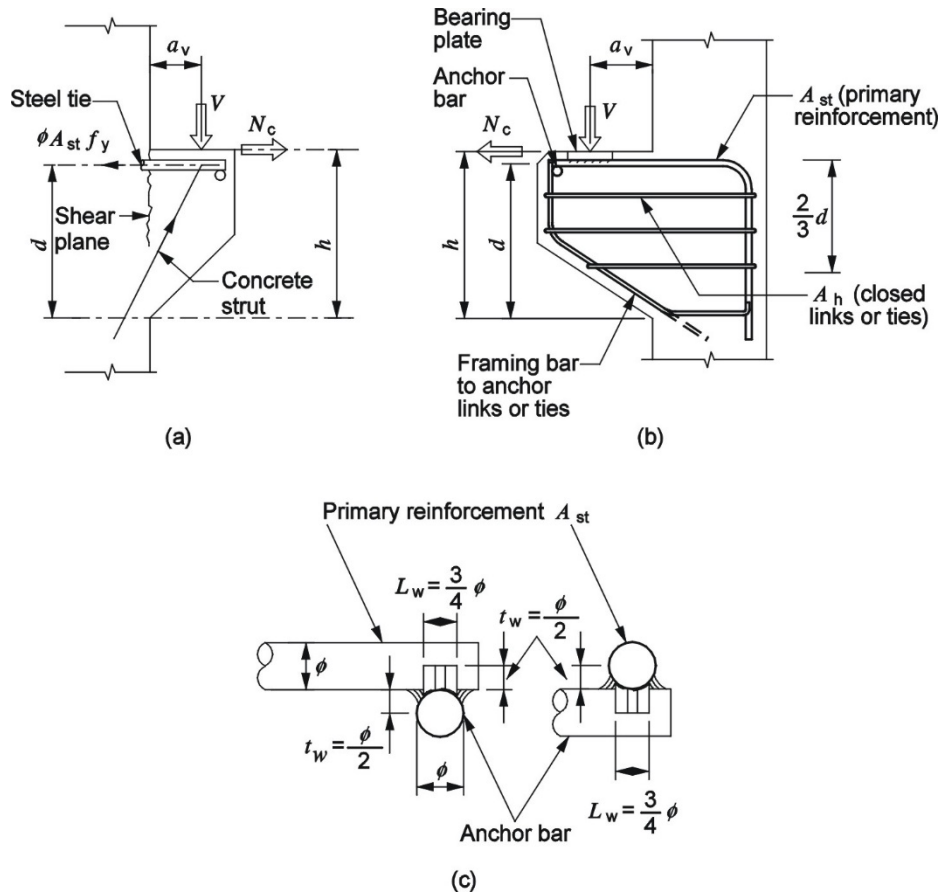

Figure 9.6 - Typical corbel detailing

9.8.4 Resistance to horizontal force

Additional reinforcement connected to the supported member should be provided to transmit this force in its entirety.

9.9 DETAILING FOR DUCTILITY

9.9.1 Beams

9.9.1.1 Critical zones

The extent of critical zone should be from the column face over a length equal to 2 times the beam depth. For other special beam configurations such as haunched beam, the critical zone may be demonstrated to suit the possible location of plastic hinge.

9.9.1.2 Longitudinal reinforcement

(a) Maximum and minimum percentages of reinforcement

The minimum percentage of reinforcement in a beam is to be in accordance with Table 9.1, however not less than 0.3%.

The maximum area of tension reinforcement within the critical zone should not exceed 2.5% of the gross cross-sectional area of the concrete. At any section of a beam within a critical zone the compression reinforcement should not be less than one-half of the tension reinforcement at the same section.

(b) Spacing

The maximum clear distance between adjacent bars in tension should not exceed the limits stated in clause 9.2.1.4.

(c) Anchorage into exterior column

When longitudinal beam bars are anchored in cores of exterior columns or beam stubs, the anchorage for tension shall be deemed to commence at $\frac{1}{2}$ of the relevant depth of the column or 8 times the bar diameter whichever is less, from the face at which the beam bar enters the column. Where it can be shown that the critical section of the plastic hinge is at a distance of at least the beam depth or 500 mm, whichever is less, from the column face, the anchorage length may be considered to commence at the column face.

For the calculation of anchorage length the bars must be assumed to be fully stressed to f_y .

Notwithstanding the adequacy of the anchorage of a beam bar in a column core or a beam stub, no bar shall be terminated without a vertical 90° standard hook or equivalent anchorage device as near as practically possible to the far side of the column core, or the end of the beam stub where appropriate, and not closer than $\frac{3}{4}$ of the relevant depth of the column to the face of entry. Top beam bars shall only be bent down and bottom bars must be bent up.

(d) Laps and type 1 mechanical couplers

For laps and type 1 mechanical couplers, no portion of the splice shall be located within one effective depth from the column/wall face.

(e) Type 2 mechanical couplers

Type 2 mechanical couplers complying with the requirements given in clause 3.2.8.4 may be used in any location.

(f) Curtailment

The distribution and curtailment of the longitudinal flexural reinforcement shall be such that the flexural overstrength of a section can be attained at critical sections in potential plastic hinge regions.

9.9.1.3 *Transverse reinforcement*

(a) Spacing

The centre-to-centre spacing of links or ties along a beam shall not exceed:

- (i) Inside the critical zone: the smaller of 150 mm or 8 times the longitudinal bar diameter
- (ii) Outside the critical zone: the smaller of the least lateral dimension of the cross section of the beam or 12 times the longitudinal bar diameter.

Links or ties shall be arranged so that every corner and alternate longitudinal bar that is required to function as compression reinforcement shall be restrained by a leg, and within the critical zone, the spacing between link legs across any section shall not exceed the smaller of 20 times the diameter of link or 250 mm.

(b) Anchorage

Links should be adequately anchored by means of hooks with bend not less than 135° in accordance with clause 8.5. Anchorage by means of welded cross bars is not permitted. Where there is adequate confinement to prevent the end anchorage of the link from "kick off", hooks with bent not less than 135° may be replaced by other standard hooks given in Figure 8.2 (see Figure 9.7).

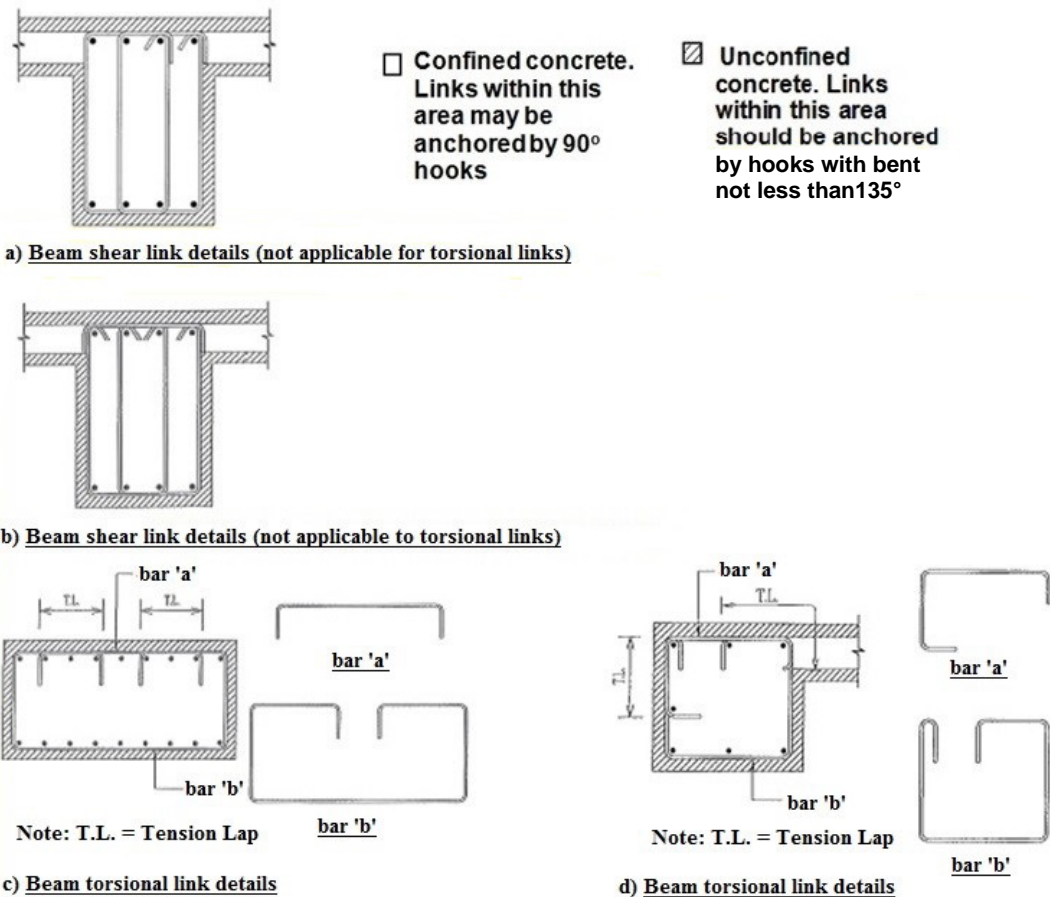

Figure 9.7 - Typical confinement in beam

9.9.2 Columns

9.9.2.1 Longitudinal reinforcement

- (a) Maximum and minimum areas of reinforcement

The area of longitudinal reinforcement based on the gross concrete area of a column shall not be less than 0.8%.

The area of longitudinal reinforcement for strength design shall not be greater than 4% of the gross concrete area except that at laps the area may increase to 5.2%.

In any row of bars the smallest bar diameter used shall not be less than $\frac{2}{3}$ of the largest bar diameter used.

- (b) Spacing

For longitudinal bars in potential plastic hinge regions, the cross-linked bars shall not be spaced further apart between centres than the larger of $\frac{1}{4}$ of the adjacent lateral column dimension or 200 mm.

- (c) Anchorage of column reinforcement

Where column bars terminate in beam-column joints or joints between columns and foundation members and where a plastic hinge in the column may be expected, the anchorage of the longitudinal column bars into the joint region shall be assumed to commence at $\frac{1}{2}$ of the depth of the beam or 8 bar diameters, whichever is less, from the face at which the column bar enters the beam or foundation member. When it is shown that a column plastic hinge adjacent to the beam face cannot occur, the development length shall be considered to commence from the beam face.

Notwithstanding the adequacy of the anchorage of a column bar into an intersecting beam, no column bar shall be terminated in a joint area without a horizontal 90° standard hook or equivalent anchorage device as near the far face of the beam as practically possible, and not closer than ¾ of the depth of the beam to the face of entry. Unless a column is designed to resist only axial forces, the direction of the horizontal leg of the bend must always be towards the far face of the column.

(d) Laps and type 1 mechanical couplers

For laps and type 1 mechanical couplers in a column, the centre of the lap or coupler must be within the middle half of the storey height of the column (see Figures 9.8 and 9.9) unless it can be shown that plastic hinges cannot develop in the column, or the condition given in expression 9.6 is complied with.

In addition to the above requirement, type 1 mechanical couplers should be staggered in at least 2 layers at not less than 900 mm apart.

$$\sum M_c \geq 1.2 \sum M_b \quad 9.6$$

where:

$\sum M_c$ is the sum of moment capacities of the columns under the appropriate axial load of the column sections above and below the joint,

$\sum M_b$ is the sum of either the clockwise or anti-clockwise moment capacities of the beams on both sides of the joint, whichever is the greater. With gravity load dominance frames where reversal beam moments will not occur at column support under lateral load cases, moment capacity with the bottom beam reinforcement in tension need not be considered.

(e) Type 2 mechanical couplers

Type 2 mechanical couplers complying with the requirements given in clause 3.2.8.4 should be staggered in at least 2 layers at not less than 300 mm apart with the lower layer at not less than 300 mm above the top level of structural floor, pile cap or transfer structure (see Figure 9.10).

9.9.2.2 Transverse reinforcement within critical zones

The extent of critical zone in columns shall be from the point of maximum moment over a finite length suggested as follows (including the zone influenced by stub effect):

For $0 < N/(A_g f_{cu}) \leq 0.1$, the extent of critical zone is taken as 1.0 times the greater dimension of the cross-section or where the moment exceeds 0.85 of the maximum moment or 1/6 of column clear height at floor, whichever is larger;

For $0.1 < N/(A_g f_{cu}) \leq 0.3$, the extent of critical zone is taken as 1.5 times the greater dimension of the cross-section or where the moment exceeds 0.75 of the maximum moment or 1/6 of column clear height at floor, whichever is larger; and

For $0.3 < N/(A_g f_{cu}) \leq 0.6$, the extent of critical zone is taken as 2.0 times the greater dimension of the cross-section or where the moment exceeds 0.65 of the maximum moment or 1/6 of column clear height at floor, whichever is larger;

where A_g is the gross area of section, mm².

(a) Minimum area of links spirals or cross-ties

The diameter of the transverse reinforcement (links, loops or helical spiral reinforcement) should not be less than 10 mm or ¼ the diameter of the largest longitudinal bar, whichever is the greater.

(b) Spacing

For rectangular or polygonal columns the centre-to-centre spacing of links or cross-ties along a column shall not exceed the smaller of 8 times the diameter of the longitudinal bar to be restrained or 150 mm. The arrangement of links or ties within the cross section shall comply with either one of the following requirements:

- (i) each longitudinal bar or bundle of bars shall be laterally supported by a link passing around the bar, or
- (ii) every corner bar and each alternate longitudinal bar (or bundle) in the outer layer of reinforcement shall be supported by a link passing around the bar, and no bar within the

compression zone shall be further than the smaller of 10 times the diameter of link or 125 mm from a restrained bar.

For circular columns the centre-to-centre spacing of spirals or circular hoops along the column shall not exceed the smaller of 8 times the diameter of the longitudinal bar to be restrained or 150 mm.

(c) Anchorage

Links and ties should be adequately anchored by means of hooks with bend not less than 135° in accordance with clause 9.5.2 (see Figure 9.5b, c, d & e). Where there is adequate confinement to prevent the end anchorage of the link from “kick off”, hooks with bend not less than 135° may be replaced by other standard hooks given in Figure 8.2.

9.9.2.3 *Transverse reinforcement outside critical zones*

Transvers reinforcement outside critical zones should be in accordance with clause 9.5.2.

9.9.2.4 *Shear reinforcement in beam-column joints*

Typical details of shear reinforcement in beam-column joints are given in Figure 9.7a.

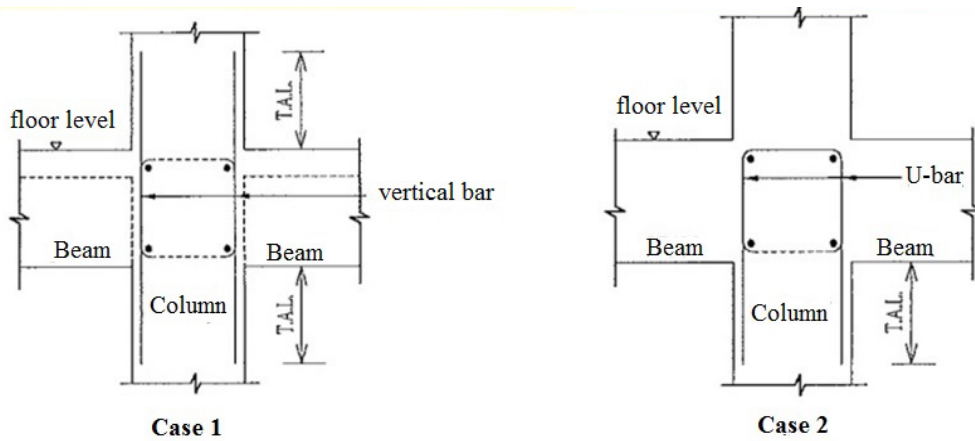

Notes:

1. Vertical shear reinforcement may be provided by vertical bars or inverted U-bars with adequate anchorages into column above or below the joint.
2. T.A.L. = Tension Anchorage Length

a) Beam-column joint - elevation showing vertical shear reinforcement

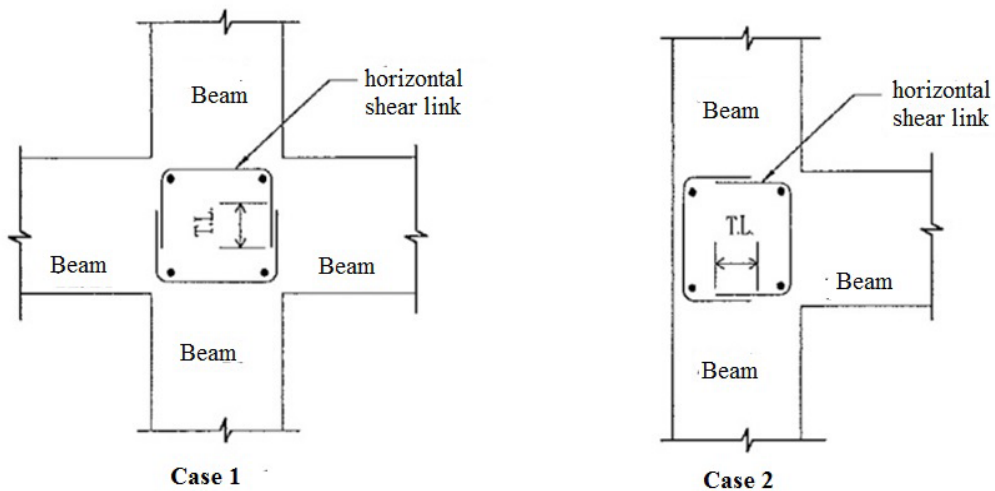

Notes:

1. Horizontal shear reinforcement may be provided by U-bars.
2. Shear reinforcement should not extend outside column section.
3. T.L. = Tension Lap

b) Beam-column joint - plan showing horizontal shear reinforcement

Figure 9.7a - Beam-Column Joint Shear Reinforcement

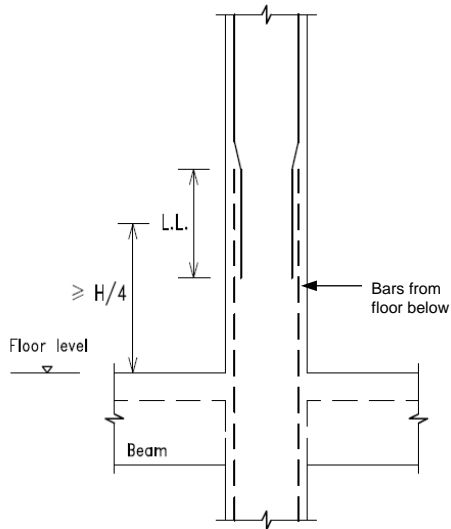

Note: Centre of the lap length (L.L.) to be located at a height not below $H/4$ above floor level (H = storey height).

Figure 9.8 - Bar lapping details for column

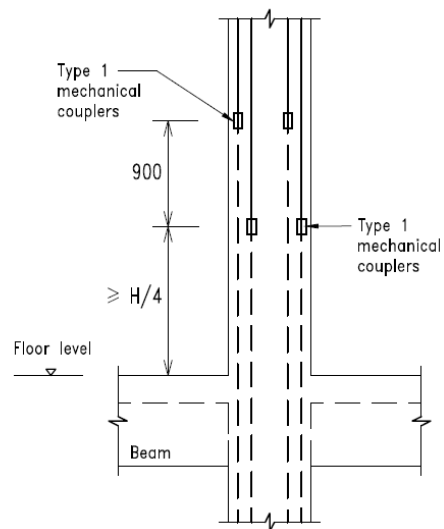

Note: Type I mechanical couplers to be located at a height not below $H/4$ above floor level and couplers to be staggered at 900 mm minimum.

Figure 9.9 - Type 1 mechanical coupler details for column

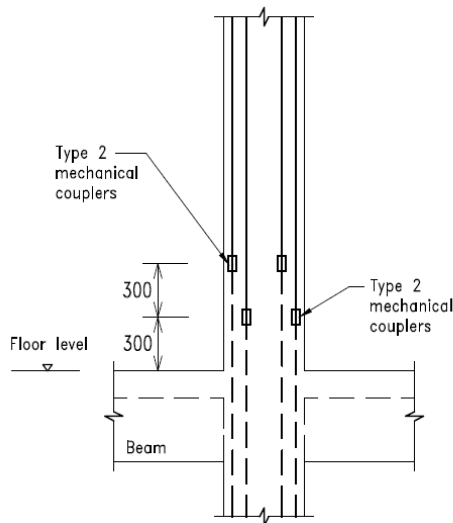

Note: Type 2 mechanical couplers should be staggered in at least 2 layers at not less than 300 mm apart with the lower layer at not less than 300 mm above floor level.

Figure 9.10 - Type 2 mechanical coupler details for column

9.9.3 Walls

9.9.3.1 Critical zone

- (a) Walls with height not exceeding 24 m

The critical zone should extend from support of the wall to ceiling of the lowest floor.

- (b) Walls with height exceeding 24 m

The critical zone should extend from support of the wall to ceiling of the second lowest floor or one-tenth of the full height of wall, whichever is the greater.

9.9.3.2 *Confined boundary elements*

Confined boundary elements are the edge regions or intersections of the cross-sections of walls, which are strengthened by confining reinforcement as specified in this clause.

(a) Type 1 confined boundary element

Type 1 confined boundary element refers to the shaded portions of the walls in Figure 9.11(a), and should be provided with vertical reinforcement satisfying the following requirements:

- (i) not less than 0.6% of the sectional area of the structural boundary element;
- (ii) not smaller than 12 mm in diameter and not less than 6 in number; and
- (iii) each vertical bar is tied with links or ties at least 10 mm diameter and vertical spacing not exceeding 250 mm.

(b) Type 2 confined boundary element

Type 2 confined boundary element refers to the shaded portions of the walls in Figure 9.11(a), and should be provided with vertical reinforcement satisfying the following requirements:

- (i) not less than 0.8% of the sectional area of the structural boundary element;
- (ii) not smaller than 16 mm in diameter and not less than 6 in number; and
- (iii) each vertical bar is tied with links or ties of at least 10 mm diameter and vertical spacing not exceeding 200 mm.

(c) Type 3 confined boundary element

Type 3 confined boundary element refers to the shaded portions of the walls in Figure 9.11(b), and should be provided with vertical reinforcement satisfying the following requirements:

- (i) not less than 1% of the sectional area of the structural boundary element;
- (ii) not smaller than 16 mm in diameter and not less than 6 in number;
- (iii) spacing not exceeding 150 mm; and
- (iv) each vertical bar is tied with links or ties of at least 12 mm diameter and vertical spacing not exceeding 150 mm.

Links and ties should be adequately anchored by means of hooks with bend not less than 135° in accordance with clause 9.5.2 (see Figure 9.5b, c, d, e & f). Where there is adequate confinement to prevent the end anchorage of the link from “kick off”, hooks with bend not less than 135° may be replaced by other standard hooks given in Figure 8.2.

9.9.3.3 *Axial compression ratio N_{cr}*

The axial compression ratio N_{cr} of walls is defined as follows

$$N_{cr} = \frac{N}{0.45 f_{cu} A_c} \quad 9.8$$

where:

- N = $1.4G_k + 1.6Q_k$
 f_{cu} is the characteristic strength of concrete
 A_c is the gross area of concrete section

N_{cr} should not be greater than 0.75.

9.9.3.4 *Walls with $0 < N_{cr} \leq 0.38$ within the critical zone*

The wall should be strengthened as follows:

- (a) the critical zone should be strengthened with type 2 confined boundary elements; and
- (b) all other storeys should be strengthened with type 1 confined boundary elements.

9.9.3.5 *Walls with $0.38 < N_{cr} \leq 0.75$ within the critical zone*

The wall should be strengthened as follows:

- (a) the critical zone and the storey immediately above should be strengthened with type 3 confined boundary elements; and
- (b) all other storeys should be strengthened with type 1 confined boundary elements.

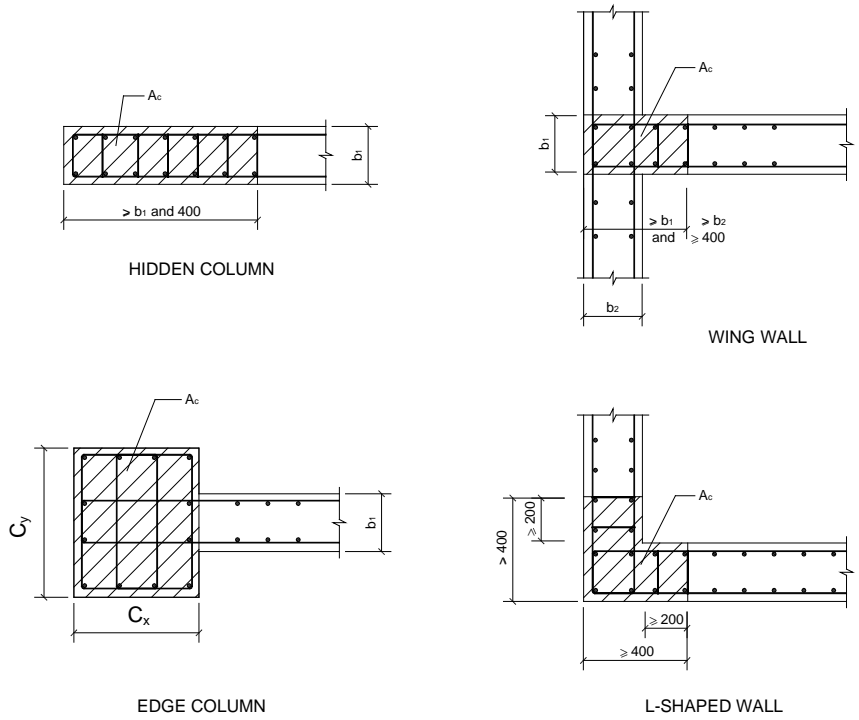

(a) Type 1 and 2 confined boundary elements

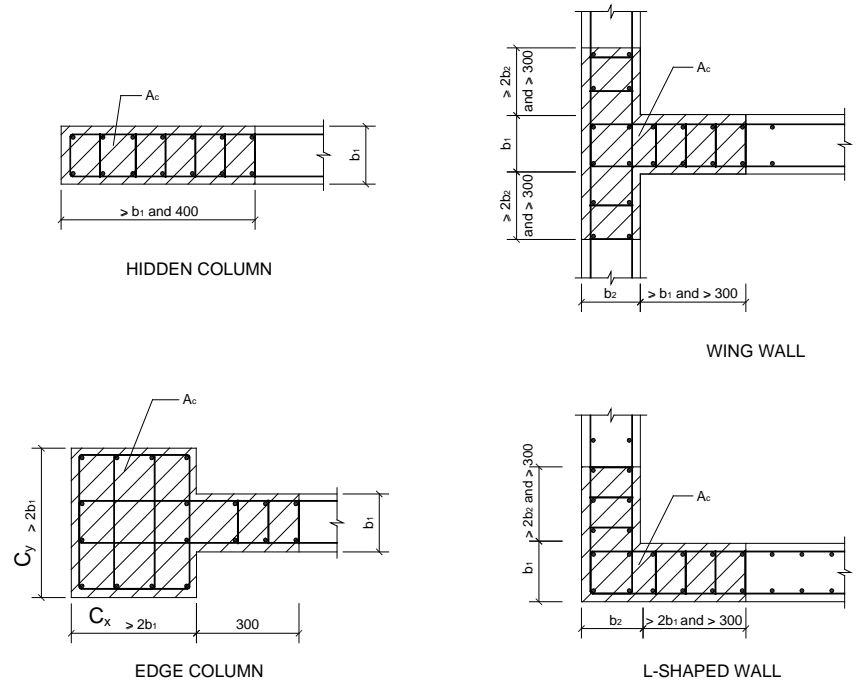

(b) Type 3 confined boundary elements

Figure 9.11 - Details of confined boundary elements

10 GENERAL SPECIFICATION, CONSTRUCTION AND WORKMANSHIP

10.1 OBJECTIVES

This section specifies the minimum required standards for materials and workmanship to comply with the design assumptions of this code of practice.

10.2 CONSTRUCTION TOLERANCES

Permissible deviations should be specified only for those dimensions that are important to the construction, performance or appearance of the structure. Guidance for designers on the accuracy that can be achieved is provided below. More stringent tolerances may be necessary for certain applications and these should be noted in the design and included in the specifications.

Space between elements;

| | | |
|-------------------------|--------------------------|---------|
| walls up to 7 m apart | - at floor | ± 24 mm |
| | - at soffit | ± 24 mm |
| columns up to 7 m apart | - at floor | ± 17 mm |
| | - at soffit | ± 18 mm |
| beams and floor slabs | - floor to soffit height | ± 23 mm |

Openings;

| | | |
|----------------|--------------------|---------|
| window or door | - width up to 3 m | ± 14 mm |
| | - height up to 3 m | ± 20 mm |

Size and shape of elements and components;

| | | |
|--|--|---------|
| walls | - thickness | ± 8 mm |
| | - straightness in 5 m | ± 9 mm |
| | - abrupt changes in a continuous surface | ± 4 mm |
| | verticality: | |
| | - up to 2 m | 11 mm |
| | - up to 3 m | 17 mm |
| - up to 7 m | 16 mm | |
| columns | - size on plan up to 1 m | ± 8 mm |
| | - verticality up to 3 m | 12 mm |
| | - verticality up to 7 m | 16 mm |
| | - squareness | 9 mm |
| beams | - depth: | |
| | - perimeter beams up to 600 mm | ± 13 mm |
| | - perimeter beams over 600 mm | ± 20 mm |
| | - internal beams up to 600 mm | ± 12 mm |
| | - internal beams over 600 mm | ± 16 mm |
| | - level: | |
| | - variation from target plane | ± 22 mm |
| - straightness in 6 m | 10 mm | |
| suspended structural floor before laying of screed | - level variation from target plane | ± 25 mm |
| | - structural soffit | ± 19 mm |
| non-suspended structural floor before laying of screed | - thickness | ± 10 mm |
| | - level variation from target plane | ± 25 mm |

| | | |
|---------------------------------|-------------------------------------|---------|
| insitu floorings without screed | - level variation from target plane | ± 15 mm |
| | - flatness | 5 mm |
| | - abrupt changes across joints | 2 mm |

Overall size on plan;

| | | |
|-------------------|------------------------------|---------|
| building | - length or width up to 40 m | ± 26 mm |
| ground floor slab | - length or width | ± 28 mm |

Position on plan in relation to the nearest reference line at the same level;

| | | |
|--|---|---------|
| foundations | - mass concrete with minimum formwork | ± 50 mm |
| | - reinforced concrete – rafts, ground beams, pile caps and footings | ± 50 mm |
| walls | | ± 16 mm |
| structural frame-columns | | ± 12 mm |
| lift walls | | ± 12 mm |
| stair wells | | ± 12 mm |
| finished stairs (flight from landing to landing) | | ± 12 mm |
| doors, windows and other openings | | ± 12 mm |
| formers for items to be cast in | | ± 6 mm |
| all other elements above foundations | | ± 12 mm |

Dimensions on plan in relation to target sizes;

| | | |
|---------------------------------|---|---------|
| foundations | - mass concrete with minimum formwork | ± 50 mm |
| | - reinforced concrete – rafts, ground beams, pile caps and footings | ± 50 mm |
| structural frame length & width | - up to 8 m | ± 16 mm |
| | - over 8 m and up to 15 m | ± 18 mm |
| | - over 15 m and up to 25 m | ± 20 mm |
| stairs-structural | - length of clear span | ± 14 mm |
| | - width of flight | ± 8 mm |
| | - difference in width of tread or going over consecutive steps | ± 10 mm |
| | - waist thickness measured square to slope of flight | ± 8 mm |
| stairs-finished | - length of clear span | ± 12 mm |
| | - width of flight | ± 10 mm |

Position in elevation in relation to the nearest reference line;

| | |
|-----------------------------------|---------|
| doors, windows and other openings | ± 15 mm |
| formers for items to be cast in | ± 10 mm |

Range in deviations in level with reference to nearest datum;

| | | |
|-------------|---|---------|
| foundations | - mass concrete: | |
| | - formation surface of excavation or blinding surface | ± 34 mm |
| | - upper surface | ± 20 mm |
| | - reinforced concrete: | |

| | | |
|-------------------------------------|---|-------------|
| | - formation surface of excavation or blinding surface | ± 30 mm |
| | - upper surface | ± 16 mm |
| concrete frame | - structural roof: | |
| | - upper surface height up to 30 m | ± 16 mm |
| | - for each subsequent 30 m | ± 8 mm |
| stairs | - vertical height of any flight between landings | ± 15 mm |
| | - difference in rise of any consecutive steps | ± 6 mm |
| | - difference in level of tread with the going | ± 4 mm |
| | - per metre width of stair | ± 5 mm |
| | - stairs finished vertical height of any flight between landings | ± 10 mm |
| doors windows and other openings | - sill and soffit, for each 1 m of width (maximum 15 mm) | ± 6 mm |
| Verticality at any point; | | |
| lift wells-each wall | - for the first 30 m of height | ± 25 mm |
| | - for each additional 12 m of height with a maximum of ± 25 mm | ± 6 mm |
| door jambs | - plumbness, for each 1 m of height with a maximum of ± 15 mm | ± 4 mm |

10.3 CONCRETE

10.3.1 Constituents

Specifications for selection of the constituent materials of concrete are given in the acceptable standards.

10.3.2 Mix specification

Recommended methods for specifying concrete are given in the acceptable standards.

10.3.3 Methods of specification, production control and transport

Methods of specification for the production and transport of concrete are given in the acceptable standards.

10.3.4 Sampling, testing and assessing conformity

10.3.4.1 General

Specifications for sampling, testing and assessing conformity are given in CS1 and the acceptable standards.

For special purposes additional cubes may be required. These cubes should be made and tested in accordance with CS1 but the methods of sampling and the conditions of storage should be specified to meet the required purpose. These special purposes include:

- (a) the strength of concrete in prestressed concrete at transfer (see clause 12.1.8.1);
- (b) the time at which to strike formwork (see clause 10.3.8.2);

Preferably sampling should be at the point of placing and the additional cubes stored under the same conditions as the concrete in the members. The additional cubes should be identified at the time of manufacture and should not be used for the conformity procedures.

10.3.4.2 Concrete Cube Tests During Construction

(a) Concrete Cubes

The compressive strength of concrete shall be determined by testing 100 mm or 150 mm cubes 28 days after mixing. A representative sample shall be taken from fresh concrete to make test cubes and each sample shall be taken from a single batch. The rate of sampling shall be at least that specified in Table 10.1 and at least one sample shall be taken from each grade of concrete produced on any one day.

| Type or part of building, building works or street works | Quantity of concrete to be represented by each sample |
|---|---|
| Masts, cantilevers more than 3 m in length, columns, shear wall, transfer structures, prestressed and other critical elements | 10 m ³ or 10 batches whichever is the smaller volume |
| Solid rafts, pile caps, caisson caps and mass concrete retaining walls | 100 m ³ or 100 batches whichever is the smaller volume |
| All other types or parts | 25 m ³ or 25 batches whichever is the smaller volume |

Table 10.1 - Sampling Rates

For each sample of concrete taken 2 cubes shall be made in accordance with CS1. Each concrete cube shall be given a number in serial sequence and no serial number shall be duplicated or omitted. All cubes shall be adequately cured on site or in the laboratory until ready for testing at 28 days after mixing. The average compressive strength of each pair of cubes made from the same sample shall be taken as the test result.

(b) Acceptance Criteria

The specified grade strength for concrete shall be deemed to have been attained if the individual test results and the average results of all overlapping sets of 4 consecutive test results comply with the criteria specified in Table 10.2. If the requirements are not satisfied by any test results, investigation shall be made to establish whether the concrete represented by the test result is acceptable or not.

| Specified Grade Strength | Compliance Criteria | Column A | | Column B | |
|--------------------------|---------------------|---|--------------|--|--------------|
| | | Average of 4 consecutive test results shall exceed the specified grade strength by at least | | Any individual test result shall not be less than the specified grade strength minus | |
| | | 150 mm Cubes | 100 mm Cubes | 150 mm Cubes | 100 mm Cubes |
| C20 and above | C1 | 5 MPa | 7 MPa | 3 MPa | 2 MPa |
| | C2 | 3 MPa | 5 MPa | 3 MPa | 2 MPa |
| Below C20 | C1 or C2 | 2 MPa | 3 MPa | 2 MPa | 2 MPa |

Table 10.2 - Compressive Strength Compliance Criteria

For concrete of Grade C20 and above, the standard deviation for each grade of concrete after every 40 test results is to be calculated. Compliance requirements C1 or C2 of Table 10.2 shall be adopted as follows:

- (i) Before 40 test results are available, where there is sufficient previous production data using similar materials from the same plant under similar supervision to establish that the standard deviation of 40 test results is less than 5 MPa for 150 mm test cubes or 5.5 MPa for 100 mm test cubes, compliance requirement C2 may be adopted; otherwise compliance requirement C1 shall be adopted.
- (ii) Where the calculated standard deviation of a set of 40 consecutive test results of concrete judged by compliance requirement C2 of Table 10.2 exceeds 5 MPa for 150 mm test cubes or 5.5 MPa for 100 mm test cubes, compliance requirement for checking the test results shall be changed from C2 to C1 on the 35th day after making the last pair of test cubes in the set of 40.

- (iii) Where the calculated standard deviation of 40 previous consecutive test results is less than 5 MPa for 150 mm test cubes or 5.5 MPa for 100 mm test cubes, compliance requirement shall be changed from C1 to C2 on the 35th day after making the last pair of test cubes in the set of 40.

When there are more than 4 test results the average of each set of 4 consecutive test results shall be calculated and checked for compliance each time a new test result is produced, using that test result and the immediately preceding 3 test results. Where there are only 2 or 3 test results available, those results shall be treated as if they were 4 consecutive test results.

If the average strength determined from any group of 4 consecutive test results does not satisfy Column A of Table 10.2 then the batches of concrete represented by the first and last samples in the group and all intervening batches shall be deemed not to have attained the specified grade strength.

If an individual test result does not satisfy Column B of Table 10.2 then only the particular batch of concrete from which the sample was taken shall be deemed not to have attained the specified grade strength provided that the averages of all groups of 4 consecutive results in which the individual test appears all satisfy Column A of Table 10.2.

If the difference between the compressive strengths of any pair of cubes made from the same sample of concrete for specified grade strength C20 and above exceeds 15% of the test result for that pair of cubes, action shall be taken to ensure that the sampling and testing procedures as required are being followed.

If the difference between the compressive strengths of any pair of cubes made from the same sample of concrete for specified grade strength C20 and above exceeds 20% of the test result for that pair of cubes, that test result shall be disregarded and investigations shall be made to establish whether the concrete represented by the test result is acceptable or not.

When the following situation occurs, the concrete mix design, the material quality, the production method and equipment, and the procedures of concrete sampling and testing should be reviewed and no further concreting of permanent works should be allowed until a steady and satisfactory production of the mix could be restored:

- (iv) For concrete grade not exceeding C60, the calculated standard deviation exceeds 8 MPa for 150 mm test cubes or 8.5 MPa for 100 mm test cubes; or
- (v) For concrete grade exceeding C60, the coefficient of variation exceeds 14%.

In case further concreting of permanent works is not allowed when either of above conditions occurs, investigation shall be carried out to find out the cause of such variation in cube strength distribution. Measures should be taken to restore a steady and satisfactory production of the concrete mix. However, in line with the investigation work, temporary resumption of concrete works can be allowed under any one of the following conditions:

- (vi) The average of the latest 40 cube test results exceeds the grade strength by at least 10 MPa for 150 mm test cubes or 12 MPa for 100 mm test cubes and all individual test results exceeds the grade strength by at least 4 MPa for 150 mm test cubes or 5 MPa for 100 mm test cubes; or
- (vii) The standard deviation or coefficient of variation of the latest 40 cube test results is found to fall below the corresponding limit again with new cube test results coming up after the incident is identified showing that the variation in cube distribution has become normal again.

Permanent resumption of concreting works is allowed when either the case is confirmed to be caused by individual cube test results deviating from the general trend of other data or the remedial actions corresponding to the identified root causes are conducted.

10.3.4.3 Further testing

- (a) When concrete is considered to be suspect from visual inspection, or when the specified grade strength has been deemed not to be attained under clause 10.3.4.2(b), the compressive strength of the concrete in the structure may be determined by drilling a sufficient number of cores from the concrete at suitable locations.
- (b) The core should be prepared in accordance with the requirements given in CS1.
- (c) Cores drilled from concrete should be prepared and tested by a recognised method to determine the compressive strength.

- (d) No adjustment should be made to the measured strength in respect of the age of the core when tested.
- (e) Criteria for acceptance
 - (i) Concrete cores should not show evidence of segregation of individual materials.
 - (ii) There should be no honeycombing in the cores which means interconnected voids arising from, for example, inadequate compaction or lack of mortar.
 - (iii) For any set of cores representing a test location, the estimated in-situ cube strength of each core specimen should be at least 75% of the specified grade strength and the average estimated in-situ cube strength of the set should be at least 85% of the specified grade strength. In this respect, the estimated in-situ cube strength of each core specimen should be calculated in accordance with CS1.

10.3.5 Placing and compacting

To ensure a high degree of compaction without segregation, fresh concrete should possess suitable workability and appropriate placing procedures and compacting equipment should be used.

Placing and compacting should be carried out under appropriate supervision as soon as practicable after mixing. Delays in placing are only acceptable provided the concrete can still be placed and fully compacted without the addition of further water.

Precautions should be taken, particularly when the concrete is allowed to fall freely through the depth of lift, to avoid segregation of the constituents and displacement of reinforcement, tendons, ducts and anchorages, or formwork, and damage to the faces of formwork. The depth of lift to be concreted should be agreed, and a cohesive, non-segregating mix may be required. Attention should be paid to the effect of lift height on the temperature rise of the concrete in massive sections.

Internal vibration should not be used to move concrete across the surface of open textured formwork as this may lead to localised honey-combing and inadequate bonding between the concrete and the reinforcement.

Under water, concrete should be placed in position by tremie or pipeline from the mixer unless specifically designed to fall freely through the water. Concrete should not be placed in flowing water.

Concrete should be thoroughly compacted during placing by vibration or other means and worked into corners of the formwork and round reinforcement, tendons, duct formers, embedded fixtures and the like to form a solid void-free mass having the required surface finish. Vibrators should be used in a manner that does not promote segregation, and vibration applied until the expulsion of air has practically ceased. Over-vibration should be avoided as this may cause the formation of a weak surface layer.

The handling and placing characteristics of fresh concrete can be improved by air-entraining and plasticising admixtures

When external vibration is used, the formwork design and vibrator disposition must ensure efficient compaction and avoid surface blemishes.

Where permanent formwork is incorporated in the structure extra care is required, as full compaction of the concrete cannot be checked after the formwork is removed. The energy absorbed by the formwork should be taken into account when deciding on the method of vibration to be used.

10.3.6 Curing

10.3.6.1 General

Curing is the prevention of loss of moisture from new concrete. Preventing moisture loss is particularly important if the water/cement ratio is low, if the cement is rapid hardening, and if the concrete contains pfa or ggbs. The curing should also maintain a satisfactory temperature regime, and avoid the development of high temperature gradients within the concrete.

Supersulfated cement concrete is seriously affected by inadequate curing and the surface has to be kept moist for at least 4 days.

Curing and protection should start immediately after the compaction of the concrete to protect it from:

- (a) premature drying out, particularly by solar radiation and wind;
- (b) rain and flowing water;
- (c) rapid cooling during the first few days after placing;

- (d) high internal thermal gradients; and
- (e) vibration and impact which may disrupt the concrete and interfere with its bond to the reinforcement.

The method of curing should be specified in detail where members are of considerable bulk or length, the cementitious content of the concrete is high, the surface finish is critical or special or accelerated curing methods are to be applied.

In particular, for high strength concretes, to limit plastic shrinkage cracking, early mist curing starting two hours after placing of the concrete should be considered.

Because of the high cementitious materials content of high strength concretes, large amounts of heat may be generated over the first few days, leading to temperature rises of as much as 60°C. The large temperature rise and subsequent temperature drop may cause serious thermal cracking problems. It is therefore recommended that for all concrete mixes of grade greater than C60, adiabatic curing tests should be carried out and a maximum temperature rise of 40°C imposed. If the adiabatic temperature rise of the concrete exceeds this value, thermal analysis should be carried out and suitable concrete cooling measures adopted during curing.

10.3.6.2 Minimum periods of curing and protection

The minimum curing period depends on the type of cement, the ambient conditions and the surface temperature of the concrete. Surfaces should normally be cured and protected for a period not less than that given in Table 10.3.

| Type of cement | Ambient conditions after casting | Minimum period of curing and protection (days) |
|--|----------------------------------|--|
| Portland Cement | average | 3 |
| | poor | 4 |
| All other cements | average | 4 |
| | poor | 6 |
| All | good | No special requirements |
| Notes: 1. Ambient conditions after casting are as follows: good: damp and protected (relative humidity greater than 80%; protected from sun and wind); average: intermediate between good and poor; poor: dry or unprotected (relative humidity less than 50%; not protected from sun and wind). | | |

Table 10.3 - Minimum periods of curing and protection

10.3.6.3 Methods

Common methods of curing are:

- (a) keep formwork in place;
- (b) cover the surface with an impermeable sheet of material such as polyethylene, which should be well sealed and fastened;
- (c) spray the surface with an efficient curing membrane;
- (d) cover the surface with damp sand, hessian, sacking or similar absorbent material; and
- (e) continuous or frequent applications of water to the surface, avoiding alternate wetting and drying and the application of cold water to warm concrete surfaces.

10.3.7 Concreting in hot weather

Special precautions may be necessary to avoid the following:

- (a) reduction in working life of fresh concrete due to loss of mix water from accelerated evaporation and hydration; and

- (b) high temperature rise leading to unacceptable levels of early age thermal cracking.
- (c) Consideration should be given to the following measures:
- (d) use of admixtures to retard hydration and increase initial workability. A retarder will not compensate for stiffening from moisture loss;
- (e) use of a cement or combination that reduces the rate of heat evolution; and
- (f) specify a maximum temperature of fresh concrete of less than 30°C.

The temperature of the concrete can be reduced by cooling the water and aggregate.

At the time of placing, the concrete temperature should not exceed 30°C, unless it can be demonstrated that a higher temperature will have no detrimental effects on the concrete.

The concrete should be placed and compacted as soon as possible after mixing. To prevent moisture loss, the curing of surfaces not protected by forms should commence immediately after compaction. It is best to provide the initial curing with sheets of impervious material, preferably pigmented to reflect radiation, supported away from the surface if the surface is not to be marked, and fastened at the edges to prevent air movement.

10.3.8 Formwork and falsework

10.3.8.1 Basic requirements

Formwork and falsework shall be designed and constructed to safely withstand without excessive deflection all the loads which may occur during the construction process.

Formwork and falsework shall be designed and erected by suitably experienced persons operating under an appropriate system of supervision and control.

Formwork and falsework should be sufficiently rigid to ensure the final concrete structure complies with the specified tolerances. They should be designed to withstand the worst combination of loads including self-weight, construction and wind loads, weight of reinforcement and wet concrete, concrete pressures, together with the dynamic effects caused by placing, vibrating and compacting the concrete.

Formwork joints should be constructed to prevent loss of grout or mortar from the fresh concrete.

Removal of formwork from the concrete should be possible without causing shock, disturbance or damage. Removal of side formwork should be so arranged that the soffit form can be retained in position, properly supported on props, until the concrete has achieved the required maturity.

If a component is to be prestressed whilst resting on the soffit form, provision should be made for elastic deformation, displacements, and any variation in mass distribution that may occur.

The internal surfaces of the formwork in contact with the concrete must be clean. Release agents should be applied so as to provide a thin uniform coating to the forms without contaminating the reinforcement, and the concrete placed while these agents are still effective. Any possible detrimental influence of these agents on the concrete surface should be considered.

Formwork spacers left insitu should not impair the desired appearance or durability of the concrete.

10.3.8.2 Removal of formwork and falsework

The time at which formwork and falsework is removed will be determined by the following factors:

- (a) concrete strength at time of removal;
- (b) stresses in the concrete at the time of removal;
- (c) curing requirements;
- (d) subsequent surface treatment requirements; and
- (e) presence of re-entrant angle formwork, which should be removed as soon as possible to avoid thermal cracking.

Formwork supporting cast insitu concrete in flexure may normally be struck when the strength of the concrete in the element is 10 N/mm² or twice the stress to which it will be subjected, whichever is the greater, provided that striking at this time will not result in unacceptable deflection, and suitable curing and protection to the concrete is provided.

In the absence of other information the recommended minimum periods before striking formwork and falsework for concrete made with Portland Cement are as follows:

- (f) 12 hrs: vertical formwork for sides of beams, columns, walls and similar locations;
- (g) 4 days: soffit formwork of slabs with props left in;

- (h) 7 days: soffit formwork of beams with props left in;
- (i) 10 days: props for slabs;
- (j) 14 days: props to beams; and
- (k) 14 days: props to cantilevers.

For long span or transfer structures, the specified cube strength must be achieved prior to removal of falsework and propping.

If pfa or ggbs is included in the concrete mix, or temperatures are below 15°C, an increase to these periods may be required.

If sliding or climbing forms are used, shorter periods than the above may be appropriate.

For post-tensioned structures, care should be taken to ensure that any propping does not interfere with the pre-stressing operations.

10.3.9 Surface finish

10.3.9.1 General requirements

The formwork should be designed and constructed in such a way that there is no unacceptable loss of fines, blemish or staining of the concrete surface. It should however be appreciated that some degree of making good is inevitable, even with precast work as it is virtually impossible to achieve dense, flat, smooth, even-coloured, blemish-free concrete surfaces directly from the formwork. Normally, because of entrapped air and water, blow holes up to 10 mm in diameter may be expected, but the surface should otherwise be free from voids, honeycombing or other large defects.

10.3.9.2 Particular requirements

Where a particular finish is required for appearance or practical reasons the requirements should be specified directly or by reference to clause 10.3.9.3 of this document, or by reference to sample surfaces.

10.3.9.3 Types of surface finish

Exposed smooth off-the-form and board marked finishes are only recommended for interior use. The following common examples are given for the guidance of designers and contractors:

(a) type A finish

This is achieved by the use of properly designed and assembled formwork or moulds of timber, plywood, plastics, concrete or steel. Small blowholes caused by entrapped air or water may be expected, but the surface should otherwise be free from voids, honeycombing and serious blemishes;

(b) type B finish

This is achieved by the use of high quality concrete and formwork. The concrete should be thoroughly compacted and all surfaces should be true, with clean arrises. Only very minor surface blemishes should occur, with no staining or discoloration from the release agent; and

(c) type C finish

This is achieved by first producing a type B finish. The finish is then improved by carefully removing all fins and other projections, thoroughly washing down, and then filling the blowholes with a cement and fine aggregate paste to match the colour of the original concrete. The release agent should be carefully chosen to ensure that the concrete surface will not be stained or discoloured. After the concrete has been properly cured, the face should be rubbed down, where necessary, to produce a smooth and even surface.

10.3.9.4 Production

The surface quality of the concrete depends on the constituents of the mix and their proportions, mixing, handling, compaction and curing, together with the type of formwork and the release agent used. Any aspects of production to achieve the required type or quality of finish may be separately specified.

10.3.9.5 Making good

Making good of surface defects may be permitted where the strength and durability of the concrete remains unimpaired, and subject to satisfactory appearance, permanence and durability of the repair.

10.3.9.6 Protection

Temporary protection may have to be provided in vulnerable areas to protect high quality surface finishes during construction. Such protection may include the fixing of lathes to arrises and the prevention of rust being carried to finished surfaces from exposed starter bars.

10.3.10 Construction joints

Construction joints should be kept to the minimum number necessary for the proper execution of the work. Their location should be decided and agreed before concrete is placed, and should normally run at right angles to the direction of the member.

The concrete at a vertical joint should be formed against a stop end and bonded with that subsequently placed against it, without provision for movement. Good workmanship is necessary to ensure the load-bearing capacity of the concrete in the area of the joint is not impaired.

Unless design considerations make this undesirable, the top surface of a layer of concrete should be level and reasonably flat. If a kicker is provided, it should be at least 70 mm high and carefully constructed. It should normally be cast with the previous concrete.

For a joint to transfer tensile or shear stresses, the surface of the first pour should be roughened to increase the bond strength and to provide aggregate interlock. The surface of horizontal joints can be roughened, without disturbing the coarse aggregate particles, by spraying the joint surface approximately 2 to 4 hours after the concrete is placed with a fine spray of water and/or brushing with a stiff brush. Vertical joints can be treated similarly if a retarder is used on the stop end, to allow the joint surface to be treated after stop end removal.

If permitted, mesh or expanded metal stop ends, which should not extend into the cover zone, can provide a rough face to the joint which can also be sprayed whilst the concrete is still green.

Where it is not possible to roughen the joint surface until the concrete has hardened, the coarse aggregate near the surface should be exposed by sand-blasting or by scale hammer or other mechanical device. Powerful hammers may damage or dislodge the coarse aggregate particles and should not be used.

The joint surface must be clean and free from loose particles before the fresh concrete is placed. Slight wetting may be needed prior to the new concrete being placed, to prevent loss of mix water. New concrete placed close to the joint must have an adequate fines content and be fully compacted and dense.

Water stops are not normally needed at horizontal construction joints.

10.3.11 Movement joints

Joint filler forming the gap at a movement joint should be firmly fixed to the first-placed concrete. If more than one strip is used, the ends should be butted closely together and taped to prevent grout leakage preventing the closure of the joint.

The concrete forming both sides of the joint should be thoroughly compacted to a uniform dense mass. Stop ends, where these are used, must not allow grout loss. Contraction joints may alternatively be introduced by the use of crack inducers.

Flexible water stops should be fixed so that they cannot become displaced from their intended position, and so that the concrete surrounding them can be fully compacted. The water stop design should recognise the problems of integral water stop construction in difficult placing conditions.

Horizontal water stops located within the concrete mass attract the risk of local honeycombing and should be avoided.

10.4 REINFORCEMENT

10.4.1 General

Reinforcement should conform to Hong Kong Construction Standard CS 2 and the acceptable standards. Different types of reinforcement may be used in the same structural member.

10.4.2 Cutting and bending

Reinforcement should be free from mechanical damage (e.g. notches or dents) and not be subjected to shock loading prior to embedment.

Reinforcement should be cut and bent in accordance with the appropriate acceptable standards.

Bending should be carried out by suitable mechanical methods using mandrels such that the bends have a substantially constant curvature.

Steel previously bent should only be reshaped with the engineer's approval and each bar should be inspected after re-bending for signs of fracture.

Grade 250 reinforcement projecting from concrete may be subsequently bent provided the radius of bend is not less than that specified in the acceptable standards. Grade 500 bars should not be bent, re-bent or straightened without the engineer's approval.

10.4.3 Fixing

The reinforcement assembly should be adequately robust to maintain the bars in their prescribed position during concreting. Unless stricter requirements are specified, the tolerances for fixing reinforcement should be as follows:

- (a) actual concrete cover not less than the nominal cover minus 5 mm.
- (b) For reinforcement located relative to only one face of a member, e.g. a straight bar in a slab, the actual concrete cover must not exceed the nominal cover plus:
 - (c) 5 mm on bars up to and including 12 mm diameter;
 - (d) 10 mm on bars over 12 mm up to and including 25 mm diameter; or
 - (e) 15 mm on bars over 25 mm diameter.

Nominal cover should be specified to all steel reinforcement including links. The specified cover should be maintained by the use of approved spacers and chairs, placed in accordance with the requirements of the acceptable standards.

Spacers and/or chairs should conform to the acceptable standards.

To position reinforcement non-structural fastenings should be made with steel wire, tying devices, or by welding (see clause 10.4.6). Projecting ends of ties or clips must not encroach into the concrete cover.

The position of reinforcement should be checked before and during concreting, to ensure that the nominal cover is maintained within the prescribed limits, especially in the case of cantilever sections. Where considered appropriate, a covermeter should be used to check the cover to reinforcement in hardened concrete.

10.4.4 Surface condition

The surface of the reinforcement should be examined prior to concreting, to ensure it is clean and free from deleterious substances, such as oil, grease, mud, loose rust or mill scale which may adversely affect the steel or concrete or the bond between them. Normal handling prior to embedment in the concrete is usually sufficient for the removal of loose rust and scale from reinforcement.

10.4.5 Laps and joints

Laps and joints should be made in accordance with the design specifications and at the positions shown on the drawings or as agreed by the engineer.

10.4.6 Welding

10.4.6.1 General

Generally, welding should be carried out under controlled conditions in a factory or workshop. Welding on site should be avoided if possible.

Welding must only be carried out on reinforcing steel that has the required welding properties.

Welded connections must be made and checked by suitably qualified persons. The competence of the welders should be demonstrated prior to, and periodically during, welding operations.

All welding should be carried out in accordance with the appropriate acceptable standards and the recommendations of the reinforcement manufacturer.

Reinforcing bars should not generally be welded at or near bends.

10.4.6.2 Use of welding

Welding may be used for the following purposes:

- (a) fixing in position, for example, by welding between intersecting bars, or between bars and other steel members. Metal-arc welding or electric resistance welding may be used on suitable steels; or
- (b) structural welds involving transfer of load between reinforcement or between bars and other steel members. Butt welds may be carried out by flash butt welding or metal-arc welding. For lapped joints, metal-arc welding or electric resistance welding may be used.

10.4.6.3 Types of welding

Types of welding permitted include:

- (a) metal-arc welding;
- (b) flash butt welding;
- (c) electric resistance welding; or
- (d) other methods.

Other methods of welding may be used subject to the approval of the client and reinforcement manufacturer.

10.4.6.4 Location of welded joints

Joints between parallel bars of the principal tension reinforcement should be staggered in the longitudinal direction, unless otherwise permitted by the engineer. Joints may be considered as staggered if the distance between them is not less than the end anchorage length for the bar.

10.4.6.5 Strength of structural welded joints

The strength of all structural welded joints should be assessed following tests on trial joints.

10.4.6.6 Welded lapped joints

The length of run deposited in a single pass should not normally exceed five times the diameter of the bar. If a longer length of weld is required, it should be divided into sections and the space between runs made not less than five times the diameter of the bar.

10.5 PRESTRESSING STEEL

10.5.1 General

Prestressing tendons should conform to the appropriate acceptable standards.

The tendons (wire, bars or cables), anchorages, couplers and sheaths shall be those specified in the design, and shall be capable of being identified as such.

10.5.2 Transport and storage

The tendons, anchorages, couplers and sheaths should be protected from harmful influences during transport, storage and also when handling.

Protective wrappings for tendons should be chemically neutral and the threaded ends of bars should be adequately protected.

To ensure protection of tendons, the following should be avoided:

- (a) mechanically damaging, work-hardening or heating prestressing tendons while handling;
- (b) unprotected storage, exposure to rain or contact with the ground;
- (c) welding or cutting in the vicinity of prestressing tendons without providing special protection from splashes;
- (d) after manufacture, any welding operation or on-site heat treatment or metallic coating such as galvanizing. This does not preclude cutting as given in clause 10.5.3.3; and
- (e) contamination liable to affect the durability or bond properties of the tendons.

When prestressing tendons have been stored on site for a prolonged period, tests should be carried out to ensure the quality of the prestressing tendons has not been significantly impaired by either corrosion, stress corrosion, loss of cross-sectional area or changes in any other mechanical characteristics.

10.5.3 Fabrication

10.5.3.1 Surface condition

At the time of incorporation in the structural member, all prestressing tendons and the surfaces of sheaths or ducts should be free from all harmful matter such as loose rust, oil, paint, soap or other lubricants. Oiled or greased tendons may be used under certain circumstances if agreed between the parties involved. Rust film is not necessarily harmful and may improve the bond, but will also increase the loss due to friction.

Tendons may be cleaned by wire brushing. Solvent solutions should only be used for cleaning with approval.

10.5.3.2 Straightness

(a) Wire

Low relaxation and normal relaxation wire should be transported in coils of sufficiently large diameter to ensure that the wire runs off straight.

(b) Strand

Prestressing strand should be transported in coils of sufficiently large diameter to ensure that the strand runs off reasonably straight.

(c) Bars

Prestressing bars should be straight. Any small adjustments for straightness carried out on site should be made by hand under the supervision of the engineer. This straightening should be carried out cold. Bars should be rejected if bent in the threaded portion.

10.5.3.3 Cutting

Cutting to length and trimming of ends should be by one of the following methods:

- (a) high-speed abrasive cutting wheel, friction saw or other mechanical method approved by the engineer; or
- (b) oxy-acetylene cutting flame, using excess oxygen to ensure a cutting rather than melting action. Note, flame cutting should only be used on raw material and not after stressing.

Neither the flame nor splashes must come into contact with either the anchorage or other tendons.

Post-tensioned tendons should not be cut less than one diameter from the anchor, and the temperature of the tendon adjacent to the anchor should be not exceed 200°C.

10.5.4 Placing

The tendons, couplers, anchorages and sheaths should be accurately placed and maintained in the positions shown on the drawings. The permitted deviation in the location of the tendon, sheath or duct former should be ± 5 mm unless otherwise stated in contract documents or shown on drawings.

The tendons, sheaths or duct formers should be fixed in position such that they will not be displaced by vibration, by concrete pressure, by workmen or by construction traffic. Prestressing tendons should be located in a way that does not unnecessarily increase the friction when they are being tensioned.

Sheaths and extractable cores should be strong enough to retain their correct section and profile and should be handled carefully to avoid damage. Joints should be the minimum practicable and adequately sealed to prevent ingress of any material until grouting has been completed. Ends of ducts should be sealed and protected after stressing and grouting. Extractable cores should not be coated with release agent except with the approval of the engineer and should be retained until the concrete has sufficient strength to prevent damage. Joints in adjacent sheaths should be staggered a minimum of 300 mm apart. Damage to ducts can occur during concreting, and if the tendon is to be inserted later, the duct should be dollied during concreting to ensure a clear passage for the tendon.

10.5.5 Tensioning

10.5.5.1 General

Depending on the form of construction, tendons may be either pre-tensioned or post-tensioned. Different procedures and equipment are used in each system and these govern the tensioning method, the form of anchorage and, in post-tensioning, the protection of the tendons.

All wires or strands stressed in one operation should where possible be taken from the same parcel. Each cable should be tagged with its number and the coil number of the steel used. Cables should

not become kinked or twisted. Individual wires and strands should be identified at both ends of the member. Do not use tendon where any strand has become unravelled from the composite unit.

10.5.5.2 Safety precautions

A stressed tendon contains a considerable amount of stored energy, which, may be released violently if there is any failure. All possible safety precautions should be taken during and after tensioning to safeguard persons from injury and equipment from damage.

10.5.5.3 Tensioning apparatus

Tendons are normally tensioned by hydraulic jacking. The tensioning apparatus should be in accordance with the following:

- (a) The tendon should be safely and securely attached to the jack or tensioning device.
- (b) Where wires or strands are stressed simultaneously, they should be of approximately equal length between anchorage points at the datum of load and extension measurement.
- (c) The tensioning apparatus should gradually impose a controlled total force and not induce dangerous secondary stresses in the tendons, anchorage or concrete.
- (d) The tendon force should be measured by direct-reading load cells or obtained indirectly from gauges that measure the pressure in the jacks. The extension of the tendon and any movement of the tendon in the gripping devices should be measurable. The load-measuring device should be accurate within $\pm 2\%$. Tendon elongation should be measured to within 2% or 2 mm, whichever is less.
- (e) Tension apparatus should be calibrated within six months.

10.5.5.4 Pre-tensioning

(a) General

The tension should be fully maintained by positive means during the period between tensioning and transfer. Stress transfer should take place slowly to minimize the adverse effect of shock on transmission length.

(b) Straight tendons

In the long-line method, locator plates should be distributed throughout the length of the casting bed to ensure the proper position of the wires or strands during concreting. To permit transfer of prestressing force to the concrete in each unit, when a number of units are made in line they should be free to slide in the direction of their length.

In the individual mould system, the moulds should provide the reaction to the prestressing force without distortion.

(c) Deflected tendons

To minimise frictional losses, the devices for locating the tendons should where possible ensure that the part in contact with the tendon is free to move in the line of the tendon. If the system used develops a frictional force, this force should be determined by test and allowed for.

For single tendons, the deflector in contact with the tendon should have a minimum radius of five times the tendon diameter for wire or 10 times the tendon diameter for strand and the total angle of deflection should not exceed 15° .

Transfer of the prestressing force to the concrete should be combined with the release of hold-down and hold-up forces, to maintain tensile and compressive stresses in the concrete within permissible limits.

10.5.5.5 Post tensioning

(a) Tendon arrangement

Where wires or strands in a cable are stressed consecutively, spacing members should be adequately rigid to avoid displacement during the successive tensioning operations.

Tendons must not pass round sharp bends or corners likely to cause failure when the tendons are under stress.

(b) Anchorages

All anchorages should conform to the acceptable standards. The anchorage system comprises the anchorage itself together with the tendons and reinforcement designed to act with the anchorage. The anchorage system should ensure the even distribution of stress in the concrete

at the end of the member and maintain the prestressing force under sustained and fluctuating load and under the effect of shock.

Split-wedge and barrel-type anchors should be of such form that, under the loads imposed during the tensioning operation, the wedges do not reach the limit of their travel before causing sufficient lateral force to grip the tendon, or cause an excessive force in the tendon.

Where proprietary anchorages are used, the anchoring procedure should strictly follow the manufacturer's instructions and recommendations.

All anchorage bearing surfaces should be clean prior to the tensioning operation.

Allowance for draw-in of the tendon during anchoring should be in accordance with the engineer's instructions, and the actual slip occurring for each individual anchorage should be recorded.

After tendons have been anchored, to avoid shock to the tendon or the anchorage the force exerted by the tensioning apparatus should be decreased gradually and steadily.

The anchorage should be protected against corrosion.

(c) Deflected tendons

Where the radius of the deflector in contact with the tendon is less than 50 times the diameter of the tendon or the angle of deflection exceeds 15° , the loss of strength of the tendon should be determined by test and allowed for.

(d) Tensioning procedure

Tendons, if possible, should be shown to be free to move in the duct before tensioning except at dead ends. Tensioning should be carried out under competent supervision to ensure the stress in the tendons increases at a gradual and steady rate.

The required tendon loads and extensions should be available to the supervisor in charge of stressing. During stressing allowance should be made for the friction in the jack, unless load cells are used, and in the anchorage.

Measurement of the extension should not commence until any slack in the tendon has been taken up. Tensioning should continue until the required tendon extension and/or load is achieved. The required extension should allow for any draw-in of the tendon occurring at the non-jacking end. A check on the accuracy of the frictional losses assumed at the design stage is provided by comparison between the measured tendon force and that calculated from the extension; if the difference is greater than 6%, corrective measures should be taken with the approval of the engineer. Records should be kept of all tensioning operations, including the measured extensions, pressure-gauge or load-cell readings and the draw-in at each anchorage.

For curved tendons, tendons made up of several constituent elements, or tendons loaded in stages, the order of loading and the magnitude of the load for each component of the tendon should be specified.

Tendons, anchorages and ducts should be effectively protected against corrosion during the period between stressing and permanent protection. Duct openings should be plugged.

10.5.6 Protection and bond of prestressing tendons

10.5.6.1 General

Prestressing tendons must be protected against mechanical damage and corrosion. Protection against fire damage may also be required.

The design may require the stressed tendon to be bonded to the structure it is prestressing.

10.5.6.2 Protection and bond of internal tendons

Cement grout or sand cement grout in accordance with clause 10.5.7 may be employed to protect and bond internal tendons to the member. Other materials based on bitumen, epoxy resins, rubber, etc. may be used to protect the tendons, provided the effects on bond and fire resistance are not important.

10.5.6.3 Protection and bond of external tendons

A tendon is considered external when after incorporation in the work but before protection, it is not embedded in the structure.

External prestressing tendons should generally be protected against mechanical damage and corrosion by an encasement of dense concrete or dense mortar of adequate thickness. Protection may also be provided by other suitable materials.

Consideration should be given to the differential movements that may arise between the structure and the applied protection. If the applied protection is dense concrete or mortar and there is the possibility of undesirable cracking, a primary corrosion protection should be used that will be unimpaired by differential movement.

When external prestressing tendons are required to be bonded to the structure, the concrete encasement should be suitably reinforced with the structure.

10.5.7 Grouting

10.5.7.1 General

The two main objectives when grouting ducts in post-tensioned concrete members are:

- (a) to prevent corrosion of the tendons;
- (b) to ensure efficient transfer of stress between the tendons and the concrete member.

To meet the first of these objectives, the grout should remain alkaline, should completely cover the tendons, and should contain no material that may promote corrosion.

The second objective requires that all voids in the ducts should be filled completely with a grout that, when hardened, has the required strength, elastic modulus and shrinkage characteristics and is bonded effectively to the tendons and the sides of the ducts. Upon freezing, the grout should not expand to an extent that will damage the concrete members.

These objectives can be met by following the recommendations given in the acceptable standards. It is essential, however, that all operations are carried out by experienced staff and that a high standard of workmanship is achieved. Records of the grout and the grouting operation should be kept.

10.5.7.2 Duct design

Ducts are usually formed from the corrugated steel ducting; this may be galvanized to protect the ducting prior to it being cast into the concrete. Short sections of ducts may be formed by inflated or compressed rubber tubing.

Sudden changes in the diameter or alignment of ducts should be avoided. Vents should be provided at crests in the duct profile, at any unavoidable major change in the section of the duct and elsewhere if required. Vents should be provided at high points if the difference in level between them and low points is greater than 0.5 m. Anchorage vents should be provided. It should be possible to close all vents.

The ingress of water into lined ducts should be prevented, it may, however, be necessary to wet unlined ducts in which case drainage vents should then be provided at low points. Vents to be used as entry points should be threaded to permit the use of a screwed connector from the grout pump. Preferably, it should be possible to grout lengths of horizontal duct from either end.

Vents and injection connections to the duct should be secure and tight. They should be able to withstand disturbance before concreting and pressures generated in testing and grouting. The lining to a vertical duct should be rigid and thick enough to resist distortion under the pressure exerted by the concrete whilst it is being placed. It may be advantageous to extend a vertical duct by a riser pipe and header tank to collect any water separating from the grout whilst it is being placed.

If the delay between inserting the tendons and grouting the duct is likely to permit corrosion of the tendons, consideration should be given to the possible use of protective soluble oils on the steel or dry air in the sheath via vapour phase inhibitors. These materials should be in accordance with the recommendations of the manufacturer and it should be verified that their use will not have an adverse effect upon the properties of the grout or its bond with the tendons.

10.5.7.3 Construction

Before the concrete is placed, duct linings should be inspected for continuity, correct alignment, secure fixing, dents, splits and holes and any defects rectified; particular attention should be paid to joints between ducts and anchorages and joints between adjacent precast units. Leaks may be traced by pressurizing the air within the duct using pressure relief valves to ensure that allowable limits are not exceeded.

Vents should be inspected to ensure that they are not blocked. Ease of movement of prestressing tendons generally indicates a free passage for the grout.

Lined ducts should be kept dry before grouting to prevent corrosion of the tendon, or excess water in the grout. It may be necessary to blow dry oil-free air through a lined duct occasionally to prevent condensation if it is left ungrouted for a considerable time. Unlined ducts may have to be wetted before grouting to prevent absorption of water from the grout by the surrounding concrete. It may be preferable to flush using clean water with compressed air.

Vertical ducts should be sealed at all times before grouting to prevent the ingress of rain and debris.

10.5.7.4 Properties of grout

(a) General

The grout should be of high fluidity and cohesion when plastic, have low shrinkage when hardening and have adequate strength when hardened. These properties depend upon the correct choice of materials and mixing procedure.

(b) Fluidity

The fluidity of the grout can be assessed using the procedures set out in the acceptable standards. Two test methods are described in the acceptable standards i.e. the immersion method and the cone method, of which the cone test is the simpler.

Required values for those tests are given in the acceptable standards.

(c) Cohesion

Cohesion is a measure of the resistance to segregation, bleeding and settlement. Whilst the cohesion can be increased by reducing the water/cement ratio, it is preferable to use admixtures to modify the viscosity or to produce the grout by high shear mixing. However, higher shear mixing may increase the rate of stiffening. Some admixtures cause a slight loss in the rate at which the hardened grout gains in strength.

For test requirements for bleeding see the acceptable standards.

(d) Compressive strength

The strength of 100 mm cubes of grout, made, cured and tested in accordance with clause 10.3.4 should be not less than 27 N/mm² at 28 days.

10.5.7.5 Composition of grout

(a) General

Grout is composed of Portland cement and water; sand, fillers and admixtures are sometimes also included.

(b) Cement

At the time of use, the cement should conform to the acceptable standards.

(c) Water

Potable water is usually suitable for making grout. Tests for assessing the suitability of water are given in the acceptable standards.

(d) Sand and fillers

Sand and fillers are normally only included in grouts placed in ducts with a diameter of more than 150 mm. Sand should conform to the grading requirements of the acceptable standards and should pass through a 1.18 mm sieve. Pfa may be used providing there is adequate information on its suitability.

(e) Admixtures

Admixtures should be used as recommended by the manufacturer and should be free of any chemical liable to promote corrosion of the tendon or cause damage to the grout, e.g. chlorides, nitrates and sulphates. Advice should be sought before including more than one admixture in a grout.

Plasticizing agents, viscosity modifying agents and gas generating admixtures may all be used. Gas generating admixtures will not remove entrapped air voids but only reduce their volume. The unrestrained expansion of a grout containing an expanding agent should not exceed 5% at 20 °C. The expansion will increase with increase of temperature and decrease with increase of pressure.

Retarders may be useful when long sections of duct are grouted.

(f) Chloride content

Chlorides from all sources, i.e. cement, water, sand, filler and admixture should not exceed 0.1% by mass of the cement.

10.5.7.6 Batching and mixing of grout

All materials should be batched by mass except the mixing water which may be batched by mass or volume. The water/cement ratio should not exceed 0.44. For a neat cement grout the optimum water/cement ratio will probably be about 0.40 and, with a suitable admixture, a water/cement ratio of 0.35 may be adequate.

The quantity of sand or filler used should not exceed 30% of the mass of the cement.

Sufficient material should be batched to ensure complete grouting of a duct making due allowance for overflow.

The grout should be mixed in a machine capable of producing a homogeneous colloidal grout and, after mixing, keeping the grout in slow continuous agitation, until it is ready to be pumped into the duct. Water should be added to the mixer first, followed by the cement. When these two materials are thoroughly mixed, sand or filler may be added.

The minimum time of mixing will depend upon the type of mixer and the manufacturer's recommendations should be followed. Generally, the minimum mixing time will be between 0.5 min and 2 min. Mixing should not normally be continued for more than 4 min. Where admixtures are used, the manufacturer's recommendations should be followed.

10.5.7.7 Grouting procedure

See the acceptable standards.

11 QUALITY ASSURANCE AND QUALITY CONTROL

11.1 SCOPE

This section specifies the minimum necessary control measures for design and construction of concrete structures. They comprise essential actions and decisions, as well as checks to be made, in compliance with specifications, standards and the general state-of-the-art, to ensure that all specified requirements are met.

11.2 QUALITY ASSURANCE

A Quality Assurance system should be established to ensure that the Control Measures outlined in clause 11.3 are complied with.

11.3 CLASSIFICATION OF THE CONTROL MEASURES

11.3.1 General

With regard to the quality control required in clause 2.1 of this code, three basic control systems are identified in terms of the parties who may exercise quality control; different objectives are defined for each system:

- (a) internal control;
- (b) external control; and
- (c) conformity control.

11.3.2 Internal control

Internal control is carried out by the designer, the contractor or by the supplier, each within the scope of his specific task in the building process. It is exercised:

- (a) on his own "internal" initiative; or
- (b) according to "external" rules established by the client or by an independent organisation.

11.3.3 External control

External control, comprising all measures for the client, is carried out by an independent organisation charged with this task by the client or by the relevant authority. External control may consist of:

- (a) the verification of internal control measures (in so far as these are made in accordance with external specifications); or
- (b) additional checking procedures independent from internal control systems.

11.3.4 Conformity control

Conformity control is exercised to verify that a particular service or production function has been carried out in conformity with the specifications previously established.

Conformity control is generally part of the external control.

11.4 VERIFICATION SYSTEMS

The frequency and intensity of control depend on the consequences caused by possible mistakes and errors in the various stages of the building process. In order to improve the effectiveness of control, different control measures are combined in a verification system.

11.5 CONTROL OF EACH STAGE OF DESIGN AND CONSTRUCTION PROCESS

According to the purpose and timing of the control, the following stages may be distinguished:

- (a) control of the design;
- (b) control of the production and construction; and
- (c) control of the completed structure.

11.6 CONTROL OF DESIGN

Control of design shall conform with statutory and administrative procedures.

11.7 CONTROL OF PRODUCTION AND CONSTRUCTION

11.7.1 Objectives

The control of production and construction comprises all measures necessary to maintain and regulate the quality of the materials and of the workmanship in conformity with specified requirements. It consists of inspections and tests and involves the assessment of test results.

Structural concrete for all works should be obtained from concrete suppliers who are certified under the Quality Scheme for the Production and Supply of Concrete (QSPSC) or similar equivalent, except for those located at remote areas (such as outlying islands) or where the volume of concrete involved is less than 50 m³. Even for these “exceptional” projects, the structural concrete should be obtained from a supplier operating an approved quality system.

11.7.2 Items of production and construction

The objects which need to be controlled are summarised in Table 11.1.

| Item | Control of material and production | Control of construction and workmanship |
|--------------------------------|---|---|
| Concrete | Constituent materials, composition, production, fresh concrete, hardened concrete. | Transport, placing, compacting, curing, surface finish. |
| Formwork and falsework | Materials. | Robustness, erection, removal, cambering, deflections, ground supports, tightness, internal surface |
| Reinforcement | Specified material properties, surface condition. | Handling and storage, cutting, assembling, fixing, laps and joints, welding, placing, cover to reinforcement. |
| Prestressing steel and devices | Specified material properties, surface condition, prestressing devices, straightness of tendons, grout. | Handling and storage, cutting placing, prestressing devices, tensioning, grouting. |

Table 11.1 - Objects of production and construction control

11.7.3 Elements of production and construction

The production and construction controls include:

- (a) initial tests and checking procedures;
- (b) test and checking in the course of construction; and
- (c) final tests and checks.

Different verification systems may be appropriate for:

- (d) a continuous production; the aim of this system is to achieve a uniform quality of the products in the long term; and
- (e) a single product; the aim is mainly to comply with the basic requirements of the project.

For a single product, it may be appropriate to concentrate on precautionary measures, in particular on initial tests and on checks during construction.

11.7.4 Initial tests

Where necessary, initial tests shall be made before the start of the construction process in order to check that the intended structure can be constructed satisfactorily using the specified materials, equipment and construction methods.

The quality and compatibility of the building materials and constituent materials for concrete, mortar, etc. should be shown to be adequate, either by reference to previous experience or by means of prior tests. Only approved materials should be used.

For the testing of concrete, see clause 10.3.

11.7.5 Checks during construction

11.7.5.1 General requirements

The dimensions, the properties of the materials and their suitability, the components built into the structure and the equipment used shall be subjected to a permanent system of verification during construction.

When materials and components are received at the site, their compliance with the terms of the original order shall be checked.

Important findings shall be filed in written reports, (for example in the site journal) which shall be available to all the parties concerned.

Depending on the degree of reliability required, additional special control measures may be agreed.

The production control of concrete, should be in accordance with QSPSC.

For all other structural materials, reference should be made to relevant technical documents (e.g. CEN-Standards).

The site journal should contain the following information as a minimum:

- (a) time needed for individual operations (e.g. placing of concrete, removal of formwork);
- (b) the delivery of construction materials and components;
- (c) the results of test and measurements;
- (d) observations and measurements on the position of the reinforcement and tendons; and
- (e) description of extraordinary occurrences.

11.7.5.2 Compliance controls and delivery to the site

The delivery note for ready-mixed concrete should be in accordance with QSPSC.

The delivery tickets for reinforcing steel should include information on the following items:

- (a) steel in long length or in reels or in "steelworks" condition;
- (b) bars or welded fabrics;
- (c) cut and bent steel; and
- (d) pre-assembled reinforcement.

For all reinforcement, it is necessary to be sure of the origin and the identity of the steel delivered. This can be ensured by:

- (e) an indication, on documents of certification, of the steel being delivered;
- (f) labels; and
- (g) rolling marks.

For prestressing steel and prestressing devices, clause 10.5 applies.

11.7.5.3 Controls prior to construction and during pre-stressing

For the controls prior to concreting, clause 10.3 applies.

For the controls prior to Prestressing, clause 10.5 applies.

11.7.6 Conformity controls

Conformity control is understood to be the combination of actions and decisions to be taken in order to verify that all requirements, criteria and conditions laid down previously are met completely. This implies completing relevant documentation.

For the conformity control of concrete, the acceptable standards applies, together with the conforming criteria for compressive strength in clause 10.3.4.

For the conformity control of steel, the codes referred to in clause 3.2.1 apply.

The conformity control of other materials should be based on International Standards or, where they do not exist, on National Standards or Approval Documents.

11.7.7 Control and maintenance of the completed structure

Access for control and maintenance of the completed structure should be provided.

12 PRESTRESSED CONCRETE

12.1 BASIS OF DESIGN

12.1.1 General

This section follows the limit state philosophy set out in section 2. As it is not possible to assume that a particular limit state will always be the critical one, design methods are given for the ultimate limit state and the serviceability limit states.

This section gives methods of analysis and design which will in general ensure that, for prestressed concrete construction, the design requirements given in section 2 are met.

Design and detailing of members should normally comply with the general rules given in clauses 12.2 to 12.12 and the particular rules for ductility given in clause 12.13. However, members not contributing in the lateral load resisting system do not need to conform to the requirements of clause 12.13.

Other methods may be used provided that they can be shown to be satisfactory for the type of structure or member considered.

12.1.2 Alternative methods

In certain cases the assumptions made in this section may be inappropriate and a more suitable method should be adopted which takes into account of the special nature of the structure.

12.1.3 Serviceability classification

In the assessment of the likely behaviour of a prestressed concrete structure or element, the amount of flexural tensile stress allowed under service load defines its class as follows:

- (a) *class 1*: no flexural tensile stresses;
- (b) *class 2*: flexural tensile stresses but no visible cracking;
- (c) *class 3*: flexural tensile stresses but surface width of cracks not exceeding 0.1 mm for members in exposure conditions 3 or 4 (see Table 4.1) and not exceeding 0.2 mm for all other members.

12.1.4 Critical limit state

In general, the design of class 1 and 2 members is controlled by the concrete tension limitations for service load conditions, but the design ultimate strength in flexure, shear and torsion should be checked. The design of class 3 members is usually controlled by ultimate limit state conditions or by deflection.

12.1.5 Durability and fire resistance

Durability and fire resistance depend on the amount of concrete cover to reinforcement and prestressing tendons and the quality of all materials and workmanship. Recommendations are given in sections 4 and 10. Fire test results or other evidence may be used to ascertain the fire resistance of a member.

12.1.6 Stability, robustness and other considerations

For recommendations on vibration and other considerations including stability, reference should be made to section 2.

12.1.7 Loads

12.1.7.1 Load values

The values of the design ultimate loads are those given in clause 2.3.2. The design loads to be used for the serviceability limit states are the characteristic values.

12.1.7.2 Design load arrangements

In general, when assessing any particular effect of loading, the arrangement of loads should be that causing the most severe effect. Consideration should be given to the construction sequence and to the secondary effects due both to the construction sequence and to the prestress particularly for the serviceability limit states.

12.1.8 Strength of materials

12.1.8.1 Characteristic strength of concrete

The appropriate grade of concrete should be selected from the preferred grades in Table 3.1. Grades C35 and C40 are the minimum recommended for post-tensioning and pre-tensioning respectively. In both cases the concrete strength at transfer should be not less than 25 N/mm².

12.1.8.2 Characteristic strength of steel

The specified characteristic strengths of reinforcement are given in clause 3.2 and those for prestressing tendons are given in clause 3.4.

12.2 STRUCTURES AND STRUCTURAL FRAMES

12.2.1 Analysis of structures

Complete structures and complete structural frames may be analysed in accordance with the recommendations of section 5 or clause 2.6.3 but, when appropriate, the methods given in clause 12.3 may be used for the analysis of individual members.

12.2.2 Relative stiffness

Relative stiffness should generally be based on the concrete section as described in clause 5.1.2.

12.2.3 Redistribution of moments

12.2.3.1 General

For concrete of strength grade not exceeding C70, redistribution of moments obtained by elastic analysis may be carried out, for the ULS only, provided the following conditions are satisfied.

- (a) equilibrium between internal forces and external loads is maintained under each appropriate combination of design ultimate load;
- (b) the reduction made to the maximum design moment within each region of hogging or sagging moments, derived from an elastic maximum moments diagram covering all appropriate combinations of design ultimate load, does not exceed 20% (but see clause 12.2.3.2 for certain structures over four storeys); and
- (c) where the design moment is reduced at a section described in b), the neutral axis depth x should be checked to see that it is not greater than the values specified in equations 6.4, 6.5 and 6.6 (see clause 6.1.2.4 (c)).

Note: In general, condition c) will limit or prevent redistribution in class 1 and 2 members, unless the prestress is small. Redistribution involving a reduction of moment in columns will generally be ruled out, unless the design ultimate axial load and the prestress in the column are small.

12.2.3.2 Restriction in structures over four storeys where structural frame provides lateral stability

The provisions of clause 12.2.3.1 apply except that the limit of b) is 10%.

12.3 BEAMS

12.3.1 General

The definitions and limitations of the geometric properties for prestressed beams are as given for reinforced concrete beams in clause 6.1.2.1 except that the overall depth of the member should be used instead of the effective depth.

12.3.2 Slender beams

Beams should not be unnecessarily slender (see clause 6.1.2.1). Particular attention should be paid to possible instability during construction as well as when under load in their final positions. Members may collapse by tilting about a longitudinal axis through the lifting points. This initial tilting, which may be due to imperfections in beam geometry and in locating the lifting points, could cause lateral bending moments and these, if too high, could result in lateral instability. The problem is complex and experience is the best guide. The following factors may require consideration:

- (a) beam geometry, i.e. type of cross-section, span/breadth/depth ratios, etc.;
- (b) location of lifting points;

- (c) method of lifting, i.e. inclined or vertical slings, type of connection between the beam and the slings; and
- (d) tolerances in construction, e.g. maximum lateral bow.

The design stresses due to the combined effects of lateral bending, dead load and prestress may need to be assessed; if cracking is possible the lifting arrangements should be changed or the beam should be provided with adequate lateral support.

12.3.3 Continuous beams

An elastic analysis may be made considering the following arrangements of load. The design loads should be those relating to the limit state considered (see clauses 2.3.2 and 2.3.3). The arrangements of load are:

- (a) any two adjacent spans loaded with the maximum design load and all other spans loaded with the minimum design load; or
- (b) alternate spans loaded with the maximum design load and all other spans loaded with the minimum design load; or
- (c) all spans loaded with the maximum design load.

Redistribution of the moments obtained by this method may be carried out for the ULS only, within the limits recommended in clause 12.2.3.

12.3.4 Serviceability limit state for beams

12.3.4.1 Section analysis

The following assumptions should be made:

- (a) plane sections remain plane;
- (b) elastic behaviour exists for concrete stresses up to the values given in clauses 12.3.4.2, 12.3.4.3 and 12.3.5;
- (c) the elastic modulus for steel is given in Figure 3.9 and Figure 3.10; for concrete see Table 3.2; and
- (d) in general, it is only necessary to calculate design stresses due to the load arrangements (see clause 12.1.7.2 or 12.3.3) immediately after the transfer of prestress and after all losses of prestress have occurred; in both cases the effects of dead and imposed loads on the strain and force in the tendons may be ignored.

12.3.4.2 Compressive stresses in concrete

In flexural members compressive stresses should not exceed $0.33 f_{CU}$ at the extreme fibre, except in continuous beams and other statically indeterminate structures where they may be increased to $0.4 f_{CU}$ within the range of support moments. In direct compression the stress should not exceed $0.25 f_{CU}$.

12.3.4.3 Flexural tensile stresses in concrete

Tension should not be allowed at mortar or concrete joints of members made up of precast units under the design load. Elsewhere stresses should not exceed the following for different classes:

- (a) *Class 1 members*: no tensile stress;
- (b) *Class 2 members*: the design tensile stresses should not exceed the design flexural tensile strength of the concrete for pre-tensioned members nor 0.8 of the design flexural tensile strength for post-tensioned members. The limiting tensile stresses are $0.45\sqrt{f_{CU}}$ for pre-tensioned members and $0.36\sqrt{f_{CU}}$ for post-tensioned members. Values are given in Table 12.1).

The design stress given in Table 12.1 may be increased by up to 1.7 N/mm^2 provided that it is shown by tests that such enhanced stress does not exceed three-quarters of the tensile stress calculated from the loading in the performance test corresponding to the appearance of the first crack. Where such increase is used, the stress in the concrete, due to prestress after losses, should be at least 10 N/mm^2 .

| Type of prestressed member | Design stress for concrete grade | | | |
|----------------------------|----------------------------------|-----|-----|--------------|
| | C35 | C40 | C50 | C60 and Over |
| Pre-tensioned | --- | 2.9 | 3.2 | 3.5 |
| Post-tensioned | 2.1 | 2.3 | 2.6 | 2.8 |

Table 12.1 - Design flexural tensile stresses for class 2 members: serviceability limit state: cracking

Where a design service load is of a temporary nature and is exceptionally high in comparison with the load normally carried, the values given in Table 12.1 may be further increased by up to 1.7 N/mm², provided that under normal service conditions the stress is compressive to ensure that any cracks which might have occurred close up.

When the stresses in Table 12.1 are exceeded for either of the reasons given above, any pre-tensioned tendons should be well distributed throughout the tension zone of the section and post-tensioned tendons should be supplemented if necessary by additional reinforcement located near the tension face of the member.

- (c) *Class 3 members:* Although cracking is allowed it is assumed that the concrete section is uncracked and that design hypothetical tensile stresses exist at the limiting crack widths in clause 12.1.3. The design hypothetical tensile stresses for use in these calculations for members with either pre-tensioned or grouted post-tensioned tendons are given in Table 12.2, modified by the coefficients in Table 12.3 and by the following.

The cracking in prestressed concrete flexural members is dependent on the member depth and the design stress given in Table 12.2 should be modified by multiplying by the appropriate factor from Table 12.3.

For composite construction when the flexural stresses given in Table 12.2 are not exceeded during construction the full depth of the section should be used when using Table 12.3.

When additional reinforcement is contained within the tension zone, and is positioned close to the tension faces of the concrete, these modified design hypothetical tensile stresses may be increased by an amount that is in proportion to the cross-sectional area of the additional reinforcement (expressed as a percentage of the cross-sectional area of the concrete in the tension zone). For 1% of additional reinforcement, the stresses may be increased by 4.0 N/mm² for groups a) and b) members and by 3.0 N/mm² for group c) members. For other percentages of additional reinforcement, the stresses may be increased in proportion up to a limit of 0.25 f_{cu} .

When a significant proportion of the design service load is transitory so that the whole section is in compression under the permanent (dead plus frequently occurring imposed) load, the foregoing hypothetical tensile stresses may be exceeded under the full service load.

| Group | Limiting crack width mm | Design stress for concrete grade | | |
|--|----------------------------|----------------------------------|-----|--------------|
| | | C35 | C40 | C50 and over |
| a) Pre-tensioned tendons | 0.1 | -- | 4.1 | 4.8 |
| | 0.2 | -- | 5.0 | 5.8 |
| b) Grouted post-tensioned tendons | 0.1 | 3.2 | 4.1 | 4.8 |
| | 0.2 | 3.8 | 5.0 | 5.8 |
| c) Pre-tensioned tendons distributed in the tensile zone and positioned close to the tension faces of the concrete | 0.1 | -- | 5.3 | 6.3 |
| | 0.2 | -- | 6.3 | 7.3 |

Table 12.2 - Design hypothetical flexural tensile stresses for class 3 members

| Depth of member mm | Factor |
|---|--------|
| 200 and under | 1.1 |
| 400 | 1.0 |
| 600 | 0.9 |
| 800 | 0.8 |
| 1,000 and over | 0.7 |
| Note: Intermediate values are found by interpolation. | |

Table 12.3 - Depth factors for design tensile stresses for class 3 members

12.3.5 Stress limitations at transfer for beams

12.3.5.1 Design compressive stresses

Design compressive stresses should not exceed $0.5f_{ci}$ at the extreme fibre nor $0.4f_{ci}$ for near uniform distributions of prestress, where f_{ci} is the concrete strength at transfer.

12.3.5.2 Design tensile stresses in flexure

Design tensile stresses in flexure should not exceed the following values (see clause 12.1.3):

- (a) *Class 1 members*: 1.0 N/mm^2 ;
- (b) *Class 2 members*: $0.45\sqrt{f_{ci}}$ for pre-tensioned members or $0.36\sqrt{f_{ci}}$ for post-tensioned members where f_{ci} as defined in clause 12.3.5.1. Members with pre-tensioned tendons should have some tendons or additional reinforcement well distributed throughout the tensile zone of the section. Members with post-tensioned tendons should, if necessary, have additional reinforcement located near the tension face of the member; or
- (c) *Class 3 members*: The design tensile stress should not, in general, exceed the appropriate value for a class 2 member. Where this stress is exceeded, the section should, in design, be considered as cracked.

12.3.6 Deflection of beams

12.3.6.1 General

The serviceability requirements for deflection are given in clause 2.2.4.2, but no numerical limits are set. For reinforced concrete, in all normal cases, deflections are controlled by limiting the ratio of span to effective depth. In general, this approach is not possible for prestressed concrete, because of the major influence of the level of prestress. When it is considered necessary to calculate deflections, the methods outlined in clause 12.3.6.2 may be used.

12.3.6.2 Method of calculation

Elastic analysis based on the concrete section properties may be used for instantaneous and long term deflection of class 1 and class 2 members, and for class 3 members where the design permanent loads result on stresses no greater than those in Table 12.1. In other cases, more rigorous calculations based on the moment-curvature relationship for cracked sections should be carried out.

Suitable levels of design loading and design criteria should be selected from section 2.3. Values for the relevant material properties may be obtained from section 3.

12.3.7 Ultimate limit state for beams in flexure

12.3.7.1 Section analysis

The following assumptions should be made:

- (a) the strain distribution in the concrete in compression is derived from the assumption that plane sections remain plane;

- (b) the design stresses in the concrete in compression are derived either from the stress-strain curve given in Figure 3.8 or from the simplified stress block given in Figure 6.1, with $\gamma_m=1.5$ in both cases;
- (c) the tensile strength of concrete is ignored;
- (d) the strains in bonded prestressing tendons and in any additional reinforcement, whether in tension or compression, are derived from the assumption that plane sections remain plane;
- (e) the design stresses in bonded prestressing tendons, whether initially tensioned or untensioned, and in any additional reinforcement are derived from the appropriate stress-strain curve; the stress-strain curves for prestressing tendons are given in Figure 3.10 and those for reinforcement in Figure 3.9 (An alternative approach for obtaining the stress in the tendons is given in clause 12.3.7.3 and Table 12.4.); and
- (f) The design stress in unbonded prestressing tendons is limited to the values given by equation 12.2 unless a higher value can be justified by a more rigorous analysis or on the basis of tests.

12.3.7.2 Symbols

For the purposes of clause 12.3.7, the following symbols apply.

- A_{ps} area of prestressing tendons in the tension zone.
- A_s area of reinforcement.
- b width or effective width of the section or flange in the compression zone.
- d effective depth to the centroid of the steel area A_{ps} .
- d_n depth to the centroid of the compression zone.
- f_{pb} design tensile stress in the tendons.
- f_{pe} design effective prestress in the tendons after all losses.
- M_u design moment of resistance of the section.
- x depth of the neutral axis.

12.3.7.3 Design formulae

The resistance moment of a beam M_u , containing bonded or unbonded tendons, all of which are located in the tension zone, may be obtained from the following equation:

$$M_u = f_{pb} A_{ps} (d - d_n) \quad 12.1$$

For a rectangular beam, or a flanged beam in which the flange thickness is not less than $0.9x$, d_n may be taken as $0.45x$.

For bonded tendons, values of f_{pb} and x may be obtained from Table 12.4. These values have been derived from the assumptions in clause 12.3.7.1.

For unbonded tendons, values of f_{pb} and x may be obtained from equations 12.2 and 12.3. The value of f_{pb} should not be taken as greater than $0.7 f_{pu}$.

$$f_{pb} = f_{pe} + \frac{70000\lambda_1}{l/d} \left(1 - 0.7\lambda_2 \frac{f_{pu} A_{ps}}{f_{cu} b d} \right) \quad 12.2$$

$$x = \lambda_2 \left[\left(\frac{f_{pu} A_{ps}}{f_{cu} b d} \right) \left(\frac{f_{pb}}{f_{pu}} \right) d \right] \quad 12.3$$

where $\lambda_1 = 1$ for $f_{cu} \leq 60$ N/mm², or $1 - 0.017\sqrt{f_{cu} - 60}$ for $f_{cu} > 60$ N/mm², and

$\lambda_2 = 2.58$ for $f_{cu} \leq 45$ N/mm², 2.78 for $45 < f_{cu} \leq 70$ N/mm², or 3.09 for $70 < f_{cu} \leq 100$ N/mm².

Equation 12.2 has been derived by taking the length of the zone of inelasticity within the concrete as $10x$. The length l should normally be taken as the length of the tendons between end anchorages. This length may be reduced in the case of continuous multi-span members when an analysis is carried out to determine the minimum number of zones of inelasticity associated with each arrangement of design load.

| $\frac{f_{pu}A_{ps}}{f_{cu}bd}$ | Design stress in tendons as a proportion of the design strength, $f_{pb}/0.87f_{pu}$ | | | Ratio of depth of neutral axis to that of the centroid of the tendons in the tension zone, x/d | | |
|---------------------------------|--|------|------|--|------|------|
| | f_{pe}/f_{pu} | | | f_{pe}/f_{pu} | | |
| | 0.6 | 0.5 | 0.4 | 0.6 | 0.5 | 0.4 |
| 0.05 | 1.00 | 1.00 | 1.00 | 0.12 | 0.12 | 0.12 |
| 0.10 | 1.00 | 1.00 | 1.00 | 0.23 | 0.23 | 0.23 |
| 0.15 | 0.95 | 0.92 | 0.89 | 0.33 | 0.32 | 0.31 |
| 0.20 | 0.87 | 0.84 | 0.82 | 0.41 | 0.40 | 0.38 |
| 0.25 | 0.82 | 0.79 | 0.76 | 0.48 | 0.46 | 0.45 |
| 0.30 | 0.78 | 0.75 | 0.72 | 0.55 | 0.53 | 0.51 |
| 0.35 | 0.75 | 0.72 | 0.70 | 0.62 | 0.59 | 0.57 |
| 0.40 | 0.73 | 0.70 | 0.66 | 0.69 | 0.66 | 0.62 |
| 0.45 | 0.71 | 0.68 | 0.62 | 0.75 | 0.72 | 0.66 |
| 0.50 | 0.70 | 0.65 | 0.59 | 0.82 | 0.76 | 0.69 |

Table 12.4 - Conditions at the ultimate limit state for rectangular beams with pre-tensioned tendons or post-tensioned tendons having effective bond

12.3.7.4 Allowance for additional reinforcement in the tension zone

In the absence of a rigorous analysis, the area of reinforcement A_s may be replaced by an equivalent area of prestressing tendons $A_s f_y / f_{pu}$.

12.3.8 Design shear resistance of beams

12.3.8.1 Symbols

For the purposes of clause 12.3.8 the following symbols apply.

A_{sv} cross-sectional area of the two legs of a link.

b_v breadth of the member, or for T-, I- and L-beams, the breadth of the rib.

Note: Where a duct occurs in a rib, the value of b_v should be reduced by the size of the duct if ungrouted and two-thirds of the size if grouted.

d distance from the extreme compression fibre to the centroid of the steel area ($A_{ps} + A_s$) in the tension zone.

d_t depth from the extreme compression fibre either to the longitudinal bars (see 12.3.8.9) or to the centroid of the tendons, whichever is the greater.

f_{cp} design compressive stress at the centroidal axis due to prestress, taken as positive,

f_{cpx} design stress at a distance x from the end of member.

f_{pe} design effective prestress in the tendons after all losses have occurred, which should not be taken as greater than $0.6f_{pu}$.

Note: Where the steel area in the tension zone consists of tendons and reinforcement, f_{pe} may be taken as the value obtained by dividing the effective prestressing force by an equivalent area of tendons equal to $(A_{ps} + A_s f_y / f_{pu})$.

- f_t maximum design principal tensile stress.
- f_{yv} characteristic strength of the reinforcement, which should not be taken as greater than 500 N/mm².
- l_p length of prestress development.
- M_O moment necessary to produce zero stress in the concrete at the extreme tension fibre; in this calculation only 0.8 of the stress due to prestress should be taken into account.
- s_v link spacing along the length of the member.
- v_c design concrete shear stress obtained from Table 6.3 in which A_s is replaced by $(A_{ps} + A_s)$ where A_{ps} and A_s are the respective areas of tendons and reinforcement in the tension zone.
- V, M design shear force and bending moment values at the section due to the particular ultimate load condition.
- V_C design ultimate shear resistance of the concrete.
- V_{CO} design ultimate shear resistance of a section uncracked in flexure.
- V_{Cr} design ultimate shear resistance of a section cracked in flexure.

12.3.8.2 Maximum design shear stress

In no circumstances should the maximum design shear stress (see clauses 12.3.8.4 and 12.3.8.5) exceed $0.8\sqrt{f_{cu}}$ or 7.0 N/mm², whichever is the lesser (this includes an allowance of 1.25 for γ_m).

12.3.8.3 Calculation of design shear resistance

The design ultimate shear resistance of the concrete alone V_C should be considered at sections that are uncracked ($M < M_O$) and at sections that are cracked ($M \geq M_O$) in flexure, as follows:

- At uncracked sections, V_{CO} should be evaluated from clause 12.3.8.4; or
- At cracked sections, V_{CO} and V_{Cr} should be evaluated from clauses 12.3.8.4 and 12.3.8.5 and the lesser value taken.

If necessary, shear reinforcement should be provided in accordance with clauses 12.3.8.7 and 12.3.8.8.

12.3.8.4 Sections uncracked in flexure

The design ultimate shear resistance of a section uncracked in flexure V_{CO} corresponds to the occurrence of a maximum design principal tensile stress at the centroidal axis of the section of $f_t = 0.24\sqrt{f_{cu}}$.

In the calculation of V_{CO} , the design value of the prestress at the centroidal axis should be taken as $0.8f_{cp}$. The value of V_{CO} is given in the following equation:

$$V_{CO} = 0.67b_v h \sqrt{f_t^2 + 0.8f_{cp}f_t} \quad 12.4$$

Values of $V_{CO} / b_v h$ obtained from equation 12.4 are given in Table 12.5 for applicable values of f_{cp} . In flanged members where the centroidal axis occurs in the flange the principal tensile stress should be limited to $0.24\sqrt{f_{cu}}$ at the intersection of the flange and web; in this calculation, 0.8 of the stress due to prestress at this intersection should be used in calculating V_{CO} .

For a section uncracked in flexure and with inclined tendons or compression zones, the design shear forces produced should be combined algebraically with the external design load effects.

| f_{cp} N/mm ² | Concrete grade | | | |
|-------------------------------|-------------------------|-------------------------|-------------------------|-------------------------|
| | 35 N/mm ² | 40 N/mm ² | 50 N/mm ² | 60 N/mm ² |
| 2 | 1.30 | 1.45 | 1.60 | 1.70 |
| 4 | 1.65 | 1.80 | 1.95 | 2.05 |
| 6 | 1.90 | 2.10 | 2.20 | 2.35 |
| 8 | 2.15 | 2.30 | 2.50 | 2.65 |
| 10 | 2.35 | 2.55 | 2.70 | 2.85 |
| 12 | 2.55 | 2.75 | 2.95 | 3.10 |
| 14 | 2.70 | 2.95 | 3.15 | 3.30 |

Table 12.5 - Values of $V_{co} / b_v h$

In a pre-tensioned member the critical section should be taken at a distance from the edge of the bearing equal to the height of the centroid of the section above the soffit. Where the section occurs within the prestressed development length, the compressive stress at the centroidal axis due to prestress, f_{cpX} , to be used in equation 12.4 may be calculated from the following relationship:

$$f_{cpX} = \frac{x}{l_p} \left(2 - \frac{x}{l_p} \right) f_{cp} \quad 12.5$$

where

f_{cp} is the design stress at the end of the prestress development length l_p .

The prestress development length should be taken as either the transmission length (see clause 12.10) or the overall depth of the member, whichever is the greater.

12.3.8.5 Sections cracked in flexure

The design ultimate shear resistance of a section cracked in flexure V_{cr} may be calculated using equation 12.6.

$$V_{cr} = \left(1 - 0.55 \frac{f_{pe}}{f_{pu}} \right) v_c b_v d + M_o \frac{V}{M} \quad 12.6$$

The value of V_{cr} should be taken as not less than $0.1 b_v d \sqrt{f_{cu}}$.

The value of V_{cr} calculated using this equation at a particular section may be assumed to be constant for a distance equal to $d/2$, measured in the direction of increasing moment, from that particular section.

For a section cracked in a flexure and with inclined tendons or compression cords, the design shear forces produced should be combined with the external design load effects where these effects are increased.

12.3.8.6 Cases not requiring shear reinforcement

Providing V is less than V_c cases not requiring shear reinforcement are:

- where V is less than $0.5V_c$;
- in members of minor importance; or
- where tests carried out in accordance with clause 2.6.3 have shown that shear reinforcement is not required.

12.3.8.7 Shear reinforcement where V does not exceed $V_c + V_r$ where $V_r = v_r b_v d$, v_r is defined in Table 6.2.

Except for the cases described in clause 12.3.8.6 links should be provided to satisfy equation 12.7.

$$\frac{A_{sv}}{s_v} = \frac{V_r}{0.87f_{yv}d} \quad 12.7$$

12.3.8.8 Shear reinforcement where V exceeds $V_c + V_r$

Links should be provided to satisfy equation 12.8.

$$\frac{A_{sv}}{s_v} = \frac{V - V_c}{0.87f_{yv}d_t} \quad 12.8$$

12.3.8.9 Arrangement of shear reinforcement

At both corners in the tensile zone, a link should pass round a longitudinal bar, a tendon, or a group of tendons having a diameter not less than the link diameter.

A link should extend as close to the tension and compression faces as possible, with due regard to cover. The links provided at a cross-section should between them enclose all the tendons and additional reinforcement provided at the cross-section and should be adequately anchored (see clause 8.5).

12.3.8.10 Spacing of shear reinforcement

The spacing of links along a member should not exceed $0.75d_t$ or four times the web thickness for flanged members. When V exceeds $1.8V_c$, the maximum spacing should be reduced to $0.5d_t$. The lateral spacing of the individual legs of the links provided at a cross-section should not exceed d_t .

12.3.9 Torsion

Calculations are required when torsional resistance is necessary for equilibrium or when significant torsional stresses may occur. The method adopted for reinforced concrete beams in clause 6.3 may generally be used.

12.4 SLABS

12.4.1 General

The recommendations given in clause 12.3 for beams apply also to slabs. The methods of analysis described in clauses 6.1.2.2 and 6.1.2.3 may be used for the ultimate limit state but elastic analysis should be used for the serviceability limit states. The design for shear should be in accordance with 12.3.8 except that shear reinforcement need not be provided if V is less than V_c , or where prototype tests carried out in accordance with clause 2.6.3.2 have shown that shear steel is not required.

12.4.2 Flat slabs

The analysis and design of flat slabs should be carried out in accordance with appropriate specialist literature.

12.5 COLUMNS

In framed structures where the mean design stress in the concrete section imposed by the tendons is less than 2.0 N/mm^2 , these may be analysed as reinforced columns in accordance with clause 6.2.1.

12.6 TENSION MEMBERS

Tensile strength should be based on the design strength ($0.87f_{pu}$) of the prestressing tendons and the strength developed by any additional reinforcement. The additional reinforcement may usually be assumed to be acting at its design stress ($0.87f_y$); in special cases it may be necessary to check the stress in the reinforcement using strain compatibility.

12.7 PRESTRESSING

12.7.1 Maximum initial prestress

The jacking force should not normally exceed 75% of the characteristic strength of the tendon but may be increased to 80% provided additional consideration is given to safety and to the load/extension characteristics of the tendon. At transfer, the initial prestress should not normally exceed 70% of the characteristic strength of the tendon, and in no case should it exceed 75%.

12.7.2 Deflected tendons in pre-tensioning systems

Consideration should be given, in determining the maximum initial prestress, to the possible influence of the size of the deflector on the strength of the tendons (see clause 10.5.5.4). Attention should also be paid to the effect of any frictional forces that may occur.

12.8 LOSS OF PRESTRESS, OTHER THAN FRICTION LOSSES

12.8.1 General

In the calculation of the design forces in tendons at various stages considered in design, allowance should be made for the appropriate losses of prestress resulting from:

- (a) relaxation of the tendon steel;
- (b) the elastic deformation and subsequent shrinkage and creep of the concrete;
- (c) slip or movement of tendons at anchorages during anchoring; and
- (d) other causes in special circumstances.

If experimental evidence on performance is not available, account should be taken of the properties of the steel and of the concrete in calculating the losses of prestress, from these causes. For a wide range of structures the simple recommendations given in 12.8.2, 12.8.3, 12.8.4, 12.8.5 and 12.8.6 may be used. However, these recommendations are necessarily general and approximate. A better estimate may often be obtained from experience, particularly with factory-produced units, where both the properties of the materials and of the units themselves are known and checked on a regular basis.

12.8.2 Relaxation of steel

12.8.2.1 General

The long term loss of force in the tendon allowed for in the design is obtained by multiplying the appropriate factor given in Table 12.6 by the 1 000 h relaxation test value (see clause 12.8.2.2). The initial force should be taken as the value immediately after stressing in the case of pre-tensioning and immediately after transfer in the case of post-tensioning. The relaxation factors given in Table 12.6 include allowances for the effects of strain reductions due to creep and shrinkage of the concrete and, in the case of pre-tensioning, due to the elastic deformation of the concrete at transfer.

| | Wire and strand | | Bar |
|-----------------|---|-----|-----|
| | Relaxation class as defined in the acceptable standards | | |
| | 1 | 2 | |
| Pre-tensioning | 1.5 | 1.2 | --- |
| Post-tensioning | 2.0 | 1.5 | 2.0 |

Table 12.6 - Relaxation factors

12.8.2.2 The 1,000 h relaxation value

The 1,000 h relaxation value should be taken from the manufacturer's appropriate certificate. The information will normally be available for initial loads of 60%, 70% and 80% of the breaking load and values for intermediate loads may be interpolated. For initial loads of less than 60% of the breaking load, the 1 000 h relaxation value may be assumed to decrease linearly from the stated value at 60% to zero at an initial load of 30% of the breaking load. In the absence of the appropriate Certificate of Approval the 1,000 h relaxation value should be taken as the maximum value for the appropriate initial load stated in the acceptable standards for the product.

12.8.2.3 Abnormal relaxation losses

Abnormal relaxation losses may occur in special cases, such as with tendons at high temperatures or when subjected to large lateral loads. Specialist literature should be consulted in these cases.

12.8.3 Elastic deformation of concrete

12.8.3.1 General

Calculation of the immediate loss of force in the tendons due to elastic deformation of the concrete at transfer may be based on the values for the modulus of elasticity of the concrete given in Section 3; in the use of these data the concrete strength at transfer should be used instead of f_{CU} , when the actual experimental values of elastic modulus are not available. The modulus of elasticity of the tendons may be obtained from Figure 3.10. In making these calculations it may usually be assumed that the tendons are located at their centroid.

12.8.3.2 Pre-tensioning

The loss of prestress in the tendons should be calculated on a modular ratio basis using the stress in the adjacent concrete.

12.8.3.3 Post-tensioning

Where tendons are not stressed simultaneously a progressive loss occurs. This should be calculated on the basis of half the product of the modular ratio and the stress in the concrete adjacent to the tendons averaged along their length; alternatively, the loss of prestress may be exactly computed on the basis of the sequence of tensioning.

12.8.4 Shrinkage of concrete

The loss of prestress in the tendons is obtained as the product of the shrinkage per unit length of the concrete and the modulus of elasticity of the tendons.

Shrinkage should be calculated in accordance with the recommendations given in clause 3.1.8.

12.8.5 Creep of concrete

12.8.5.1 General

The loss of prestress in the tendons may be calculated on the assumption that creep is proportional to the stress in the concrete. The loss of prestress is obtained as the product of the creep per unit length of the concrete adjacent to the tendons and the modulus of elasticity of the tendons. In this calculation it is usually sufficient to consider the tendons as located at their centroid.

12.8.5.2 Specific creep strain

The creep strain of the concrete should be calculated in accordance with the recommendations given in clause 3.1.7. The stress in the concrete should be taken as the initial value immediately after transfer, and the modulus of elasticity of the concrete at transfer should be adopted.

12.8.6 Draw-in during anchorage

In post-tensioning systems allowance should be made for any movement of the tendon at the anchorage when the prestressing force is transferred from the tensioning equipment to the anchorage. The loss due to this movement is particularly important in short members, and the allowance made in design should be checked on site.

12.9 LOSS OF PRESTRESS DUE TO FRICTION

12.9.1 General

In post-tensioning systems there will be movement of the greater part of the tendon relative to the surrounding duct during the tensioning operation. If the tendon is in contact with either the duct or any spacers provided, friction will cause a reduction in the prestressing force as the distance from the jack increases. In addition, a certain amount of friction will be developed in the jack itself and in the anchorage through which the tendon passes.

In the absence of satisfactory evidence the stress variation likely to be expected along the design profile should be assessed in accordance with clauses 12.9.2, 12.9.3, 12.9.4 and 12.9.5, in order to obtain the prestressing force at the critical sections considered in design. The extension of the tendon should be calculated allowing for the variation in tension along its length.

12.9.2 Friction in jack and anchorage

Friction in jack and anchorage varies considerably and should be determined by calibration for the actual jack and the type of anchorage to be used.

12.9.3 Friction in the duct due to unintentional variation from the specified profile

12.9.3.1 General

Whether the desired duct profile is straight or curved or a combination of both, there will be slight variations in the actual line of the duct, which may cause additional points of contact between the tendon and the sides of the duct, and so produce friction.

12.9.3.2 Calculation of force

The prestressing force P_x at any distance x from the jack may be calculated from the following equation:

$$P_x = P_0 e^{-Kx} \quad 12.9$$

where

P_0 is the prestressing force in the tendon at the jacking end;

e is the base of Napierian logarithms (2.718);

K is the coefficient depending on the type of duct or sheath employed, the nature of its inside surface, the method of forming it and the degree of vibration employed in placing the concrete (see clause 12.9.3.3).

12.9.3.3 Profile coefficient

The value of K per metre length in clause 12.9.3.2 should generally be taken as not less than 33×10^{-4} but where strong rigid sheaths or duct formers are used, closely supported so that they are not displaced during the concreting operation, the value of K may be taken as 17×10^{-4} , and for greased strands running in plastic sleeves the value of K may be taken as 25×10^{-4} . Other values may be used provided they have been established by suitable tests.

12.9.4 Friction due to curvature of tendons

12.9.4.1 General

In this case the loss of tension due to friction is dependent on the angle turned through and the coefficient of friction, μ , between the tendon and its supports.

12.9.4.2 Calculation of force

The prestressing force P_x at any distance x along the curve from the tangent point may be calculated from the following equation:

$$P_x = P_0 e^{-\mu x / r_{ps}} \quad 12.10$$

where

P_0 is the prestressing force in the tendons at the tangent point near the jacking end;

μ is the coefficient of friction;

r_{ps} is the radius of curvature;

e is as defined in clause 12.9.3.2.

The value of μ depends upon the type and the surface condition of the tendon and the duct, and so is subject to wide variations (see clause 12.9.4.3).

12.9.4.3 Coefficient of friction

Typical values of μ to be used in equation 12.10 are as follows, and may be used in the absence of more exact information. Heavy rusting of either the tendon or the duct will give rise to higher values.

Lightly-rusted strand running on unlined concrete duct: 0.55. Lightly-rusted strand running on lightly-rusted steel duct: 0.30. Lightly-rusted strand running on galvanized duct: 0.25. Bright strand running on galvanized duct: 0.20. Greased strand running on plastic sleeve: 0.12.

The value of μ may be reduced where special precautions are taken and where results are available to justify the value assumed; for example, a value of $\mu = 0.10$ has been observed for strand moving on rigid steel spacers coated with molybdenum disulfide (see also clause 12.9.5).

12.9.5 Lubricants

If of satisfactory formulation, lubricants may be used to ease the movement of tendons in the ducts. Lower values for μ than those given in clause 12.9.4.3 may then be used subject to their being determined by trial. The criteria of clause 10.5.3.1 should then be satisfied if the tendons are subsequently to be bonded into the structure.

12.10 TRANSMISSION LENGTHS IN PRE-TENSIONED MEMBERS

Refer to clause 8.10.2.2.

12.11 END BLOCKS IN POST-TENSIONED MEMBERS

12.11.1 General

In the design of end blocks, consideration should be given to:

- (a) bursting forces around individual anchorages (see clause 12.11.2 and 12.11.3);
- (b) overall equilibrium of the end block; and
- (c) spalling of the concrete from the loaded face around anchorages.

Note: Information on items b) and c) is given in specialist literature.

12.11.2 Serviceability limit state

At the SLS the design bursting tensile force, F_{bst} , in an individual square end block loaded by a symmetrically-placed square bearing plate, may be derived from Table 12.7 on the basis of the tendon jacking load. With rectangular anchorages and/or rectangular end blocks, the bursting tensile forces in the two principal directions should be assessed in relation to the value of y_{po}/y_o for each direction where:

- y_o is half the side of the end block;
- y_{po} is half the side of the loaded area;
- P_o is the tendon jacking force.

Circular bearing plates should be treated as square plates of equivalent area.

| | | | | | | |
|--|------|------|------|------|------|------|
| y_{po}/y_o | 0.2 | 0.3 | 0.4 | 0.5 | 0.6 | 0.7 |
| F_{bst}/P_o | 0.23 | 0.23 | 0.20 | 0.17 | 0.14 | 0.11 |
| Note: Intermediate values may be interpolated. | | | | | | |

Table 12.7 - Design bursting tensile forces in end blocks

This force, F_{bst} , will be distributed in a region extending from $0.2 y_o$ to $2 y_o$ from the loaded face, and should be resisted by reinforcement in the form of spirals or closed links, uniformly distributed throughout this region, and acting at a stress of 200 N/mm².

When a large block contains several anchorages it should be divided into a series of symmetrically-loaded prisms and each prism treated in the above manner. However, additional reinforcement will be required around the groups of anchorages to ensure overall equilibrium of the end block.

Special attention should also be paid to end blocks having a cross-section different in shape from that of the general cross-section of the beam.

12.11.3 Ultimate limit state

For members with unbonded tendons the design bursting tensile force, F_{bst} , should be assessed from Table 12.7 on the basis of the characteristic tendon force; the reinforcement provided to sustain this force may be assumed to be acting at its design strength ($0.87f_y$). No such check is necessary in the case of members with bonded tendons.

12.12 CONSIDERATIONS AFFECTING DESIGN DETAILS

12.12.1 General

The considerations in clauses 12.12.2 to 12.12.7 are intended to supplement those given in clause 8.10.

12.12.2 Limitations on area of prestressing tendons

The size and number of prestressing tendons should be such that cracking of the concrete would precede failure of the beam.

This requirement may be considered to be satisfied if the ultimate moment of resistance (see clause 12.3.7) exceeds the moment necessary to produce a flexural tensile stress in the concrete at the extreme tension fibres equal to $0.6\sqrt{f_{cu}}$. In this calculation the prestress in the concrete may be taken as the value after all losses have occurred.

12.12.3 Cover to prestressing tendons

12.12.3.1 Bonded tendons

(a) General

The cover to bonded tendons should conform to the relevant recommendations of clause 4.2.4 together with those of clause 12.12.3.1(b) for protection of the steel against corrosion, of clause 12.12.3.1(c) for protection of steel against fire and, where appropriate, of clause 12.12.3.1(d) for post-tensioned construction.

The ends of individual pre-tensioned tendons do not normally require concrete cover and should preferably be cut off flush with the end of the concrete member.

(b) Cover against corrosion

The exposure conditions for the structural element should be assessed in accordance with clause 4.2.4.3 and the required nominal cover, grade and associated mix limitations obtained from Table 4.2. The recommendations of clause 4.2 for concrete materials and mixes also apply to Table 4.2 except that the minimum cementitious content should not be reduced below 300 kg/m³.

(c) Cover as fire protection

The general recommendations for protection against fire given in clause 4.3 also apply to prestressed concrete.

(d) Post-tensioned construction

The cover to the outside of ducts used in bonded post-tensioned construction should be in accordance with the recommendations given in clauses 12.12.3.1(b) and 12.12.3.1(c). The equivalent bar size for ducts containing a number of strands should be calculated from the total area of the tendons within the duct.

The minimum cover to the outside of the duct should be not less than the minimum dimension of the duct cross-section nor less than half the largest dimension of the duct cross-section.

Precautions should be taken to ensure specified covers, particularly to large or wide ducts, are achieved with well-compacted concrete.

12.12.3.2 Unbonded tendons

The cover to the duct of unbonded tendons should be in accordance with the recommendations given in clause 12.12.3.1(b) and, unless the duct, sheathing and/or protective packing (e.g. grease) adequately inhibit corrosion, the recommendations given in clause 12.12.3.1(c). The nominal cover to the duct should not be less than 25 mm.

12.12.3.3 External tendons

Where external tendons are to be protected by dense concrete of at least grade C40, added subsequently, the thickness of this cover should not be less than that required for tendons inside the structural concrete under similar conditions. The concrete cover should be anchored by reinforcement to the prestressed member and should be checked for crack control in accordance with clause 7.2.

12.12.3.4 Curved tendons

For cover to curved tendons, see clause 8.10.1.2(b).

12.12.4 Spacing of prestressing tendons and ducts

Refer to clause 8.10.1.

12.12.5 Longitudinal reinforcement in prestressed concrete beams

Reinforcement may be used in prestressed concrete members either to increase the strength of sections or to conform to clause 12.3.8.9.

Any calculation taking account of additional reinforcement should still be in accordance with clauses 12.3.4.1 and 12.3.7.1.

Reinforcement may be necessary, particularly where post-tensioning systems are used, to control any cracking resulting from restraint to longitudinal shrinkage of members provided by the formwork during the time before the prestress is applied.

12.12.6 Links in prestressed concrete beams

The amount and disposition of links in rectangular beams and in the webs of flanged beams will normally be governed by considerations of shear (see clause 12.3.8).

Links to resist the bursting tensile forces in the end zones of post-tensioned members should be provided in accordance with clause 12.11.

Where links are required in the transmission length of pre-tensioned members, they should be provided in accordance with clause 12.3.8, using the information given in clause 12.10.

12.12.7 Impact loading

When a prestressed concrete beam may be required to resist impact loading, it should be reinforced with closed links and longitudinal reinforcement preferably of mild steel. Other methods of design and detailing may be used, provided it can be shown that the beam can develop the required ductility.

12.13 DUCTILITY

12.13.1 Beam-column Joints

Beam-column joints should comply with the design and detailing requirements in clauses 6.8 and 9.9.

End blocks for post-tensioned members should not be located within beam-column joints unless it can be demonstrated that the beam-column joint can resist both the anchorage tensile bursting stresses and the joint forces in clauses 6.8 and 9.9.

Ducts for post-tensioned grouted tendons through beam-column joints should be corrugated, or should provide equivalent bond characteristics.

12.13.2 Beams

In critical zones of the beams, the following criteria should be satisfied:

- (a) The depth of the neutral axis at ultimate limit state should not exceed $0.2h$.
- (b) In rectangular beams, or in T- or L- beams where the compression zone is on the opposite side of the flange, the area of compression reinforcement times its yield stress ($A_s f_y$) should not be less than 0.15 times the compression force.
- (c) Transverse reinforcement should comply with clause 9.9.1.3 and with longitudinal spacing no greater than six times the diameter of the smallest longitudinal bars.

12.13.3 Columns

Columns should comply with the design and detailing requirements in clause 9.9.2.

13 LOAD TESTS OF STRUCTURES OR PARTS OF STRUCTURES

13.1 GENERAL

This section refers to the testing of whole structures, finished parts of a structure or structural components during the construction phase. Model or prototype testing is not included, nor the appraisal of structures that have been in service for sometime. Additional consideration and reference should be made elsewhere to specialist literature under such circumstances. It is also assumed that the structure and components have been designed in accordance with this Code of Practice.

The following circumstances may arise during construction:

- (a) where the compliance procedures indicate that the materials used may be sub-standard or defective;
- (b) where supervision and inspection procedures indicate poor workmanship on site, producing construction outside the specification and design;
- (c) where there are visible defects, particularly at critical sections or in sensitive structural members;
- (d) where a check is required on the quality of the construction.

After a systematic and progressive investigation to assess the structure as built and to decide whether or not it meets the requirements of the original design; if a load test is deemed necessary, it may be to check on either strength or serviceability. It should be recognised that loading a structure to its design ultimate loads may impair its subsequent performance in service, without necessarily giving a true measure of load-carrying capacity. While such overload tests may sometimes be justified, it is generally recommended that the structure be loaded to a level appropriate to the serviceability limit states. Sufficient measurements of deformations should be taken, together with the results from the test described in clause 13.2 can then be used to calibrate the original design in predicting the ultimate strength and long-term performance of the structure.

Specialist literature should be referenced on the testing procedures. Some general principles are given in clauses 13.2 to 13.5.

13.2 TEST LOADS

The total load to be carried (W) should be not less than 1.0 times the characteristic dead load plus 1.0 times the characteristic imposed load, and should normally be the greater of (a) the sum of the characteristic dead load and 1.25 times the characteristic imposed load or (b) 1.125 times the sum of the characteristic dead and imposed loads. In deciding on suitable figures for this, and on how to apply the test load to the structure, due allowance should be made for finishes, partitions, etc and for any load sharing that could occur in the completed structure, i.e. the level of loading should be representative and capable of reproducing the proper internal force system reasonably closely.

Test loads should be applied and removed incrementally, while observing all proper safety precautions. The test loading should be applied at least twice, with a minimum of 1h between tests, and allowing 5 min after a load increment is applied before recording deformation measurements. Consideration may also be given to a third application of load, which is left in position for 24 h.

13.3 ASSESSMENT OF RESULTS

In determining deformation measurements, due allowance should be made for changes in environmental conditions that have occurred during the test.

The main objective in assessing the results is to compare the measured performance with that expected on the basis of the design calculations. This means that due allowance should be made for any differences in material strength, or stress, or other characteristic, in the as-built structure, compared with that assumed in the design. Steps should be taken to determine these material parameters as accurately as possible using standard control test results, tensioning records (for prestressed concrete), etc.

13.4 TEST CRITERIA

In assessing test data and in recalculation procedures, the following criteria should be considered:

- (a) the initial deflection and cracking should be in accordance with the design requirements;
- (b) where significant deflections have occurred under the normal loads given in clause 13.2, the percentage recovery after the second loading should be at least equal that for the first loading cycle, and should be at least 75% for reinforced concrete and class 3 prestressed concrete, and

85% for classes 1 and 2 prestressed concrete. However where the measured deflection are very small (e.g. $< \text{span}/1000$), estimates of recovery become meaningless.

- (c) the structure should be examined for unexpected defects, which should then be evaluated in the recalculation procedures. Comparisons between measured and predicted results are important. Where there are significant differences, then the first step should be to check that the structures is not carrying the load in a way different from that assumed in the design (due, for example, to arching action, or the influence of 'non-load-bearing' elements). Material properties may need to be checked as well.

13.5 SPECIAL TESTS

In certain cases, it may be necessary to devise special tests to reproduce the internal force system expected in the completed structure. This need can arise where the final boundary conditions have not yet been achieved in the construction. Such tests should be relevant, and agreed in advance by all the parties concerned.

ANNEX A

ACCEPTABLE STANDARDS

This annex contains the standards acceptable to the Building Authority to be used in conjunction with this Code of Practice. Where it is intended to use other standards or technical criteria, it should be demonstrated that they could achieve a performance equivalent to the acceptable standards as specified in this code. Future update of this list can be accessed from the Buildings Department website www.bd.gov.hk.

| <u>Standard</u> | <u>Title</u> |
|--|--|
| Codes of Practice issued by the Buildings Department, Hong Kong | |
| (a) | Code of Practice for Dead and Imposed Loads |
| (b) | Code of Practice on Wind Effects in Hong Kong |
| (c) | Code of Practice for Fire Safety in Buildings |
| (d) | Code of Practice for Precast Concrete Construction |
| (e) | Code of Practice for Structural Use of Steel |
| Construction Standards issued by the Development Bureau, Hong Kong | |
| (f) | Construction Standard CS1: Testing Concrete |
| (g) | Construction Standard CS2: Steel Reinforcing Bars for the Reinforcement of Concrete |
| (h) | Construction Standard CS3: Aggregates for Concrete |
| ASTM A416.2012 | Standard Specification for steel strand, uncoated seven-wire for prestressed concrete |
| AC 133:2008 | Acceptance Criteria for Mechanical Connector Systems for Steel Reinforcing Bars |
| BS EN 197-1:2011 | Cement. Composition, specifications and conformity criteria for common cements |
| BS 410-1:2000 | Test sieves. Technical requirements and testing. Test sieves of metal wire cloth |
| BS 410-2:2000 | Test sieves. Technical requirements and testing. Test sieves of perforated metal plate |
| BS EN 1008:2002 | Mixing water for concrete. Specification for sampling, testing and assessing the suitability of water, including water recovered from processes in the concrete industry, as mixing water for concrete |
| BS 3892:Part 1:1982 | Pulverized-fuel ash: Specification for pulverized-fuel ash for use as a cementitious component in structural concrete (The criterion for water requirement may not apply) |
| BS 6588:1985 | Specification for Portland pulverized-fuel ash cement |
| BS EN 450-1:2005 +A1:2007 | Fly ash for concrete. Definition, specifications and conformity criteria |
| BS EN ISO 17640:2010 | Non-destructive testing of welds. Ultrasonic testing. Techniques, testing levels, and assessment |
| BS 4449:2005 +A2:2009 | Steel for the reinforcement of concrete. Weldable reinforcing steel. Bar, coil and decoiled product. Specification |
| BS 4482:2005 | Steel wire for the reinforcement of concrete products. Specification |
| BS 4483:2005 | Steel fabric for the reinforcement of concrete. Specification |
| BS 4486:1980 | Specification for hot rolled and hot rolled and processed high tensile alloy steel bars for the prestressing of concrete |

| | |
|------------------------------|---|
| BS EN 13391:2004 | Mechanical tests for post-tensioning systems |
| ETAG 013 | Post Tensioning Kits for prestressing of Structures |
| BS EN 480-4:2005 | Admixtures for concrete, mortar and grout. Test methods. Determination of bleeding of concrete |
| BS EN 480-2:2006 | Admixtures for concrete, mortar and grout. Test methods. Determination of setting time |
| BS EN 480-5:2005 | Admixtures for concrete, mortar and grout. Test methods. Determination of capillary absorption |
| BS EN 480-6:2005 | Admixtures for concrete, mortar and grout. Test methods. Infrared analysis |
| BS EN 480-10:2009 | Admixtures for concrete, mortar and grout. Test methods. Determination of water soluble chloride content |
| BS EN 480-8:1997 | Admixtures for concrete, mortar and grout. Test methods. Determination of the conventional dry material content |
| BS EN 934-2:2009 | Admixtures for concrete, mortar and grout. Concrete admixtures. Definitions, requirements, conformity, marking and labelling |
| BS EN 480-1:2006 +A1:2011 | Admixtures for concrete, mortar and grout. Test methods. Reference concrete and reference mortar for testing |
| BS EN 480-12:2005 | Admixtures for concrete, mortar and grout. Test methods. Determination of the alkali content of admixtures |
| BS EN 480-11:2005 | Admixtures for concrete, mortar and grout. Test methods. Determination of air void characteristics in hardened concrete |
| BS EN 934-6:2001 | Admixtures for concrete, mortar and grout. Sampling, conformity control and evaluation of conformity |
| BS EN 934-2:2009 | Admixtures for concrete, mortar and grout. Concrete admixtures. Definitions, requirements, conformity, marking and labelling |
| BS EN 1011-2:2001 | Welding. Recommendations for welding of metallic materials. Arc welding of ferritic steels |
| BS EN ISO 17637:2011 | Non-destructive testing of welds. Visual testing of fusion-welded joints |
| BS 5896:2012 | High tensile steel wire and strand for the prestressing of concrete. Specification |
| BS EN ISO 9934-1: 2001 | Non-destructive testing. Magnetic particle testing. General principles |
| BS EN ISO 17660-1: 2006 | Welding. Welding of reinforcing steel. Load-bearing welded joints |
| BS EN ISO 17660- 2:2006 | Welding. Welding of reinforcing steel. Non load-bearing welded joints |
| BS 7973-1:2001 | Spacers and chairs for steel reinforcement and their specification. Product performance requirements |
| BS 7973-2:2001 | Spacers and chairs for steel reinforcement and their specification. Fixing and application of spacers and chairs and tying of reinforcement |
| BS 882:1992 | Specification for aggregates from natural sources for concrete |
| BS 8500-1:2006 | Concrete. Complementary British Standard to BS EN 206-1. Method of specifying and guidance for the specifier |

| | |
|--------------------------------|---|
| BS 8500-2:2006 | Concrete. Complementary British Standard to BS EN 206-1. Specification for constituent materials and concrete |
| BS 8666:2005 | Scheduling, dimensioning, bending and cutting of steel reinforcement for concrete. Specification |
| BS EN 197-1:2000 | Cement. Composition, specifications and conformity criteria for common cements |
| BS EN 197-1:2011 | Cement. Composition, specifications and conformity criteria for common cements |
| BS EN 445:2007 | Grout for prestressing tendons. Test methods |
| BS EN 446:2007 | Grout for prestressing tendons. Grouting procedures |
| BS EN 447:2007 | Grout for prestressing tendons. Basic requirements |
| BS EN 10080:2005 | Steel for the reinforcement of concrete. Weldable reinforcing steel. General |
| BS EN 15167-1:2006 | Ground granulated blast furnace slag for use in concrete, mortar and grout – Part 1: Definitions, specifications and conformity criteria (Excluding the statistical assessment by the manufacturer in Clause 8) |
| BS EN 197-4:2000 | Cement – Part 4: Composition, specifications and conformity criteria for low early strength blastfurnace cements |
| CSA-A23.5-M86 | Supplementary Cementing Materials |
| BS EN 13263-1:2005 +A1:2009 | Silica fume for concrete. Definitions, requirements and conformity criteria |